

# MISSING SOMETHING?

¿TE FALTA ALGO? / DES PIÈCES MANQUANTES ? / FEHLT ETWAS? / ONTBREEKT ER IETS?



## USA/CANADA

parts.KidKraft.com

## EUROPEAN REGIONS

parts.KidKraft.eu

## AUSTRALIA

parts.KidKraft.au

### Welcome to the KidKraft family

We do our very best to ensure accuracy in every order, but occasionally we miss something. That's why our warranty covers every single part of your new product for 90 days after purchase. If you are missing parts or find any damage, it's easy to order replacements at **parts.KidKraft.com** in the US and **parts.kidkraft.eu** in Europe. You can also review your warranty, download assembly instructions and more by visiting **KidKraft.com**.

### Bienvenido a la Familia Kidkraft

Hacemos nuestro mejor esfuerzo para asegurar la precisión en cada orden, pero a veces se nos olvida algo. Por este motivo, nuestra garantía cubre cada parte de su nuevo producto por los próximos 90 días después de su compra. Si a le falta alguna parte o si consigue algún daño en el producto, es muy sencillo solicitar un remplazo en **parts.KidKraft.com** en los Estados Unidos y en **parts.kidkraft.eu** en Europa. También puede revisar su garantía, descargar instrucciones de ensamblaje y mucho más visitando **KidKraft.com**.

### Bienvenue à la famille Kidkraft

Nous faisons de notre mieux pour assurer l'exactitude dans chaque commande, mais parfois nous manquons quelque chose. C'est pourquoi notre garantie couvre chaque partie de votre nouveau produit pendant 90 jours après l'achat. Si vous manquez des pièces ou trouvez des dommages, c'est facile de commander des pièces de rechange chez **parts.KidKraft.com** aux États-Unis et **parts.kidkraft.eu** en Europe. Vous pouvez également consulter votre garantie, télécharger les instructions d'assemblage et plus encore en visitant **KidKraft.com**.

### Willkommen zu KidKraft Family

Wir geben unser Bestes, bei jeder Bestellung sicherzustellen, dass höchste Sorgfalt geboten wird, aber vereinzelt kann es vorkommen, dass wir etwas übersehen. Aus diesem Grund deckt unsere Garantie jedes einzelne Teil Ihres neuen Produkts für die Dauer von 90 Tagen nach Erwerb ab. Sie können ganz einfach Ersatzteile bei **parts.KidKraft.com** in den USA und **parts.KidKraft.eu** in Europa bestellen, sollten Teile fehlen oder Beschädigungen vorliegen. Besuchen Sie **KidKraft.com**, um unter anderem die Garantie einzusehen und Aufbauanleitungen herunterzuladen.

### Welkom bij de Kidkraft-familie

Wij doen ons best om erg nauwkeurig te zijn bij elke bestelling, maar af en toe kunnen we wat missen. Daarom dekt onze garantie elk onderdeel van uw nieuwe product gedurende 90 dagen na aanschaf. Als er onderdelen ontbreken of als u schade opmerkt, kunnen vervangende onderdelen eenvoudig worden besteld op **parts.KidKraft.com** in de VS en **parts.kidkraft.eu** in Europa. U kunt tevens uw garantie bekijken, montage-instructies en meer downloaden door **KidKraft.com** te raadplegen.

BATCH CODE









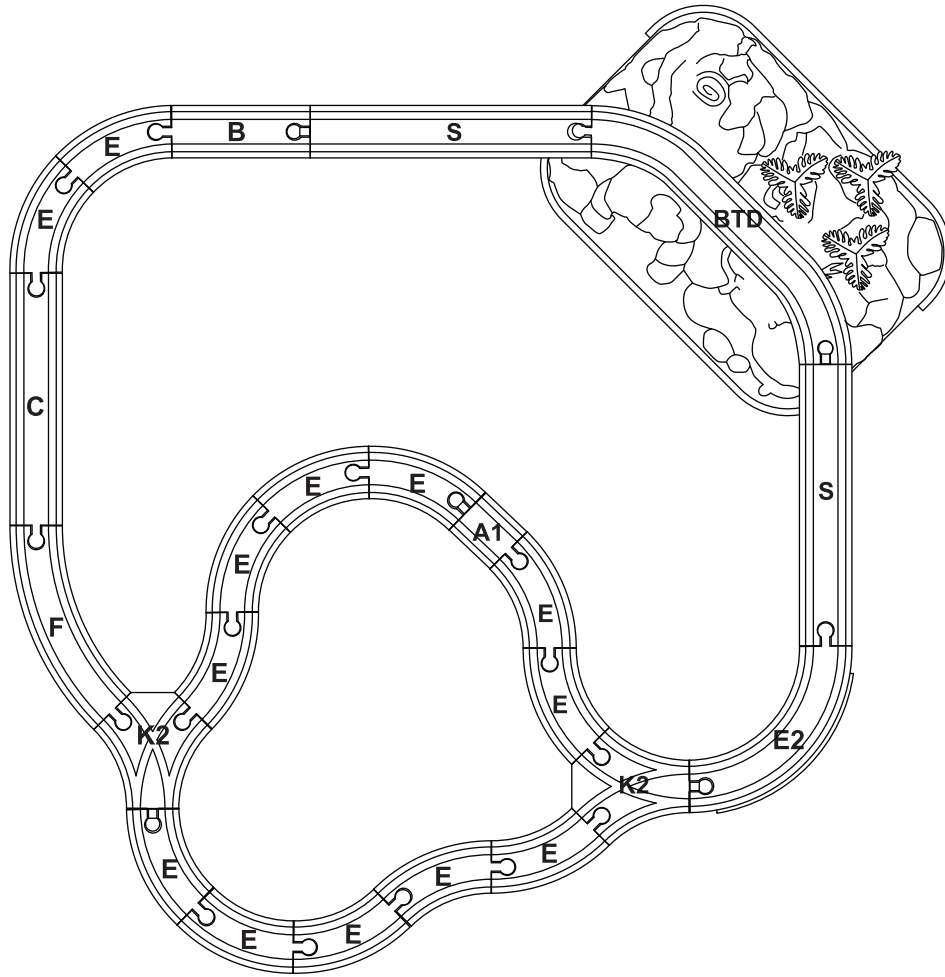

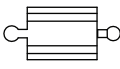
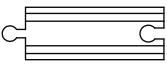
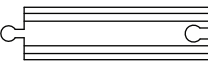

**KidKraft®**

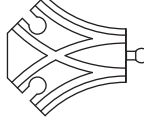
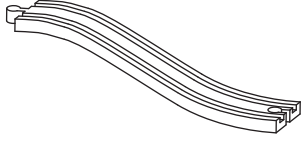
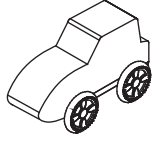
Item Number  
Número del artículo  
Description d'un article  
Artikelnummern  
Artikelnummers

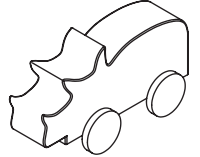
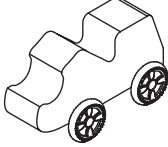
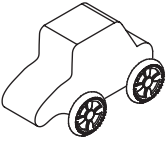
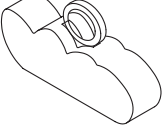
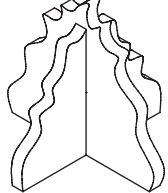
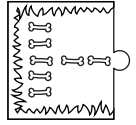
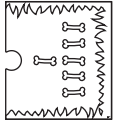
18016

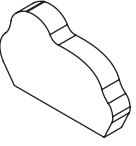

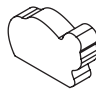
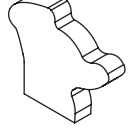
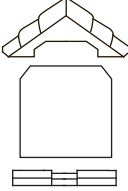
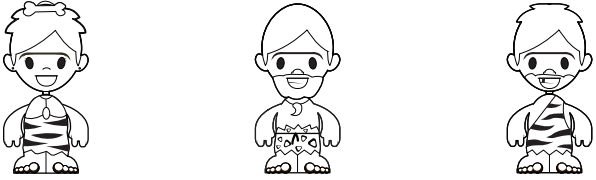
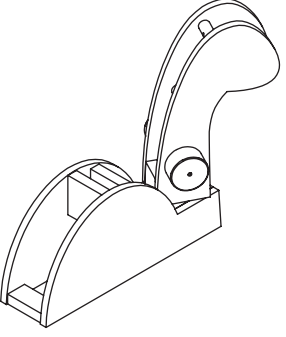
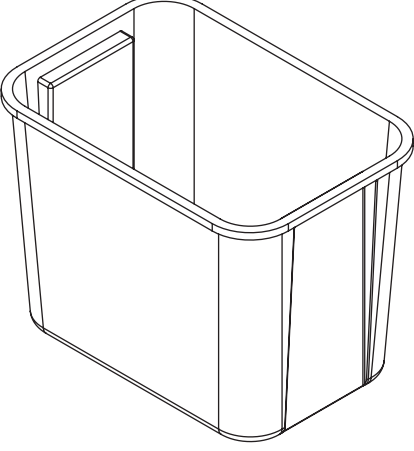
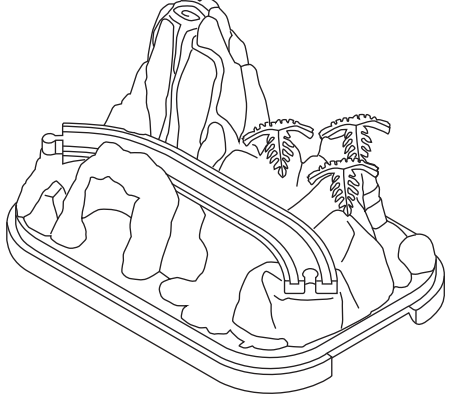
A1	B	C	E	E2	F
 x 1	 x 1	 x 1	 x 13	 x 1	 x 1
K2	S		1225	1793	1794
 x 2	 x 2		 x 2	 x 1	 x 1
1795	1800	1791	3990	2355	2357
 x 1	 x 1	 x 3	 x 1	 x 1	 x 1
1263	1186	4121	4122	4123	4124
 x 2 x 2 = 4	 x 2	 x 1	 x 1	 x 1	 x 1
1182		3847			
 x 1 x 1 x 1 = 3		 x 1 x 1 x 1			
LGS		4009		BTD	
 x 1		 x 1		 x 1	

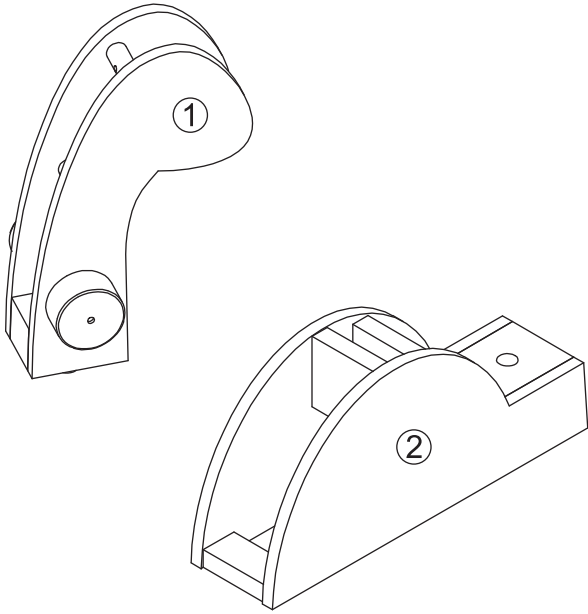

Step  
Paso  
Étape  
Schritt  
Stap

1

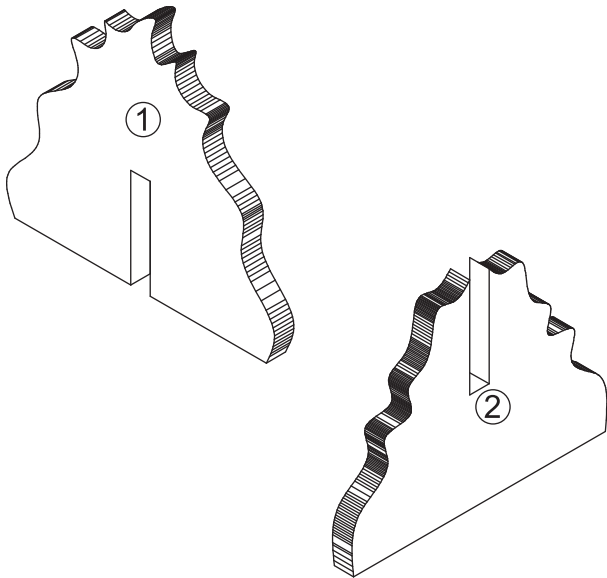
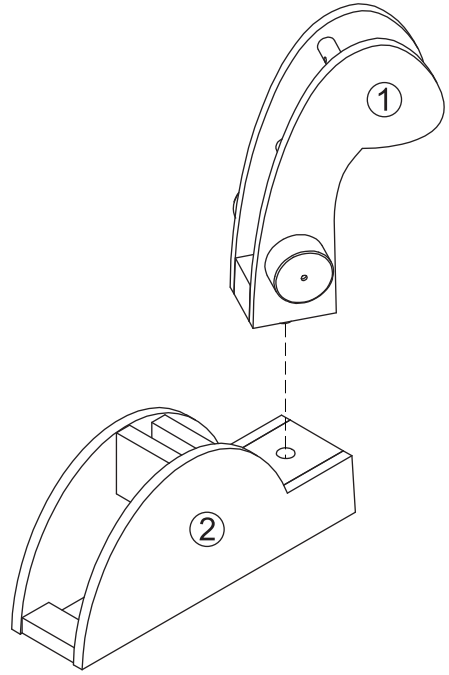

Step  
Paso  
Étape  
Schritt  
Stap

1

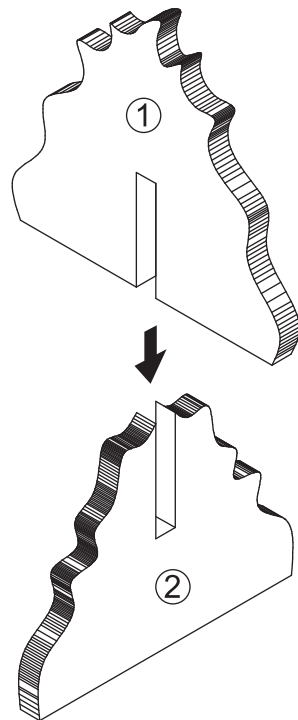

**KidKraft®**