

HARZ - 7,29m²

Caseta Metálica
Metal Shed
Maison Metal
Casota de metal

REF: KIS12120

EAN: 8445401010852

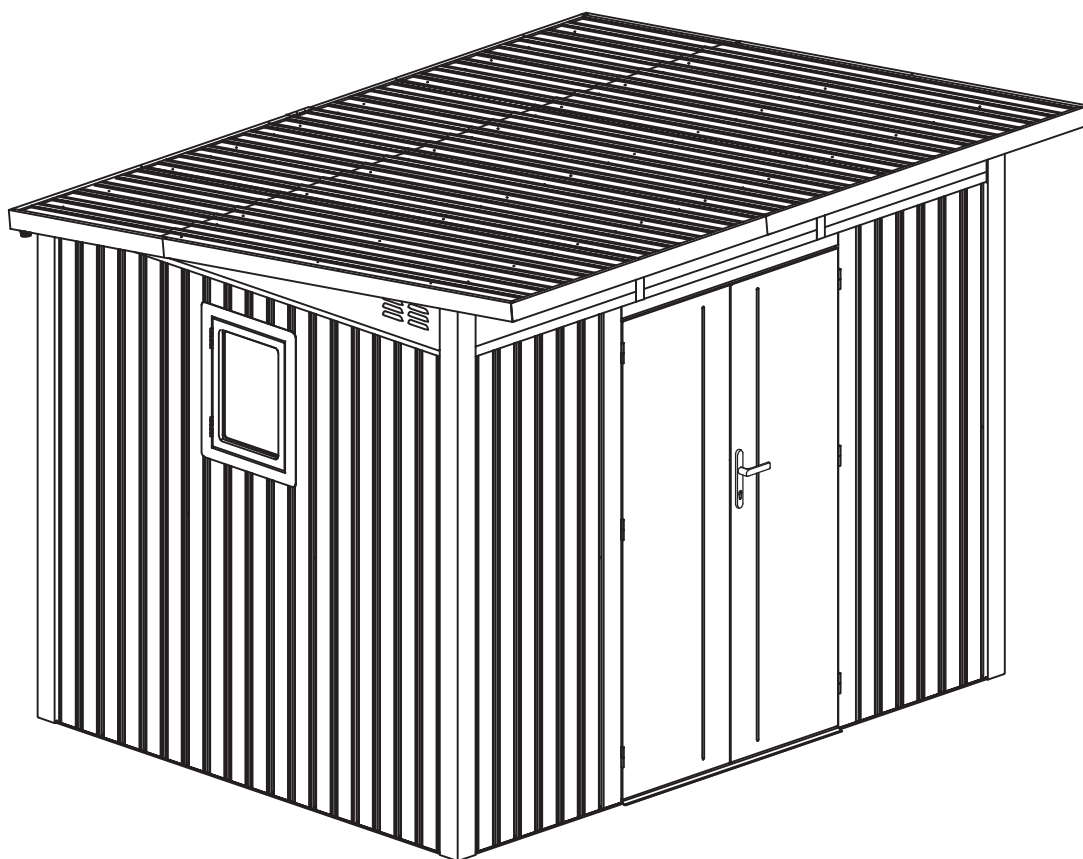

ES Manual de instrucciones

EN Instruction manual

FR Instructions de service

PT Manual de instruções

Gardiun
SPACES TO ENJOY

Manual del Usuario

Por favor, consulte la normativa referente a la construcción, ubicación y otros requerimientos antes de comenzar la instalación de su caseta metálica. Repase este manual de instrucciones antes de comenzar la instalación ya que contiene información y consejos para un montaje más sencillo y agradable.

Instrucciones de instalación

Antes de iniciar la instalación, asegúrese de leer cuidadosamente las instrucciones y siga los pasos de instalación uno por uno para terminar con éxito.

Selección de la ubicación de instalación

Recomendamos la instalación sobre una zona nivelada con buen drenaje. La caseta metálica debe anclarse para evitar percances derivados de la acción del viento. El kit no incluye la base por lo que deberá adquirirla por separado o construir la cimentación o el sistema de anclaje por sus propios medios. Para la cimentación es necesario construir una base cuadrada y nivelada. No se recomienda usar la caseta en sitios de costa.

Lista de piezas y accesorios

Por favor verifique y revise la integridad de los componentes necesarios de acuerdo con la lista de partes (despegue la película protectora de plástico antes de ensamblar las piezas, y si es necesario, note y conserve el número de etiqueta): Herramientas necesarias (ver la figura):

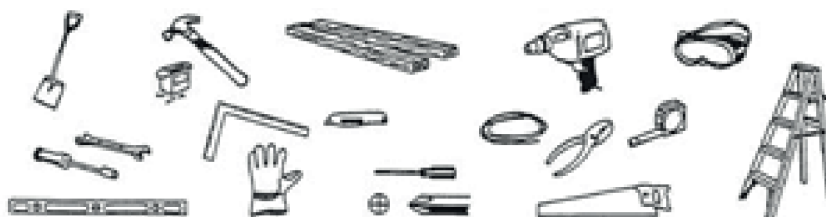

Por favor preste atención a la seguridad al utilizar las herramientas.

Precauciones

1. Se realiza la instalación en días secos y sin viento. Se necesitan dos o más personas trabajando en equipo para completar la instalación de este cuarto de almacenamiento.
2. Use guantes de seguridad, gafas y ropa de manga larga para instalar con el fin de evitar daños teniendo en cuenta que algunas partes pueden ser cortantes.
3. Se prohíbe la entrada de los niños y mascotas en el sitio de construcción.
4. Se prohíbe concentrar el peso del cuerpo en el techo. Cuando se utilicen la escalera u otras herramientas, asegúrese la operación correcta para garantizar su seguridad.

Mantenimiento

1. Mantenga limpio el interior y exterior del cuarto de almacenamiento y utilice un trapo y agua para limpiar.
2. Para garantizar que la puerta pueda deslizarse suavemente, mantenga limpio el carril de la puerta y limpie a tiempo los residuos y basuras.
3. En caso de leves o fuertes nevadas existe riesgo de derrumbe. Límpiela con las herramientas necesarias y asegúrese que es seguro entrar en el interior.
4. El presente cuarto de almacenamiento está destinado solamente a almacenar objetos, y se prohíben la residencia u otros efectos.

Notice De Montage

Avant de commencer le montage, merci de vérifier auprès de votre mairie les contraintes liées à votre commune en matière d'implantation d'abris de jardin. Veuillez aussi lire entièrement et attentivement cette notice avant de commencer le montage de votre abri.

Lieu de montage de votre abri et dalle béton

Choisir un endroit protégé des vents violents. Votre abri devra obligatoirement être fixé sur une dalle béton que vous aurez préalablement réalisée. Celle dalle béton devra être parfaitement plane. A noter que cet abri n'inclut pas de plancher ni kit d'ancrage.

Inventaire

Faites l'inventaire des pièces présentées ci-dessous. Vérifiez que tous les éléments sont bien présents avant de commencer le montage.

Supprimer le film de protection avant le montage.

Outillage nécessaire

Voire les éléments présentés sur le visual ci-dessous. Veuillez faire attention à la sécurité lors de l'utilisation de ces outils.



Consignes à observer pour le montage

1. Privilégiez un endroit protégé des vents violents.
2. 2 personnes sont nécessaires pour le montage.
3. Eloignez les enfants et animaux domestiques. Pour éviter toute blessure, portez des gants de sécurité, des lunettes protectrices et mettez des vêtements à manches longues. Attention particulièrement aux angles vifs des éléments.
4. Ne pas monter sur le toit.

Maintenance et entretien





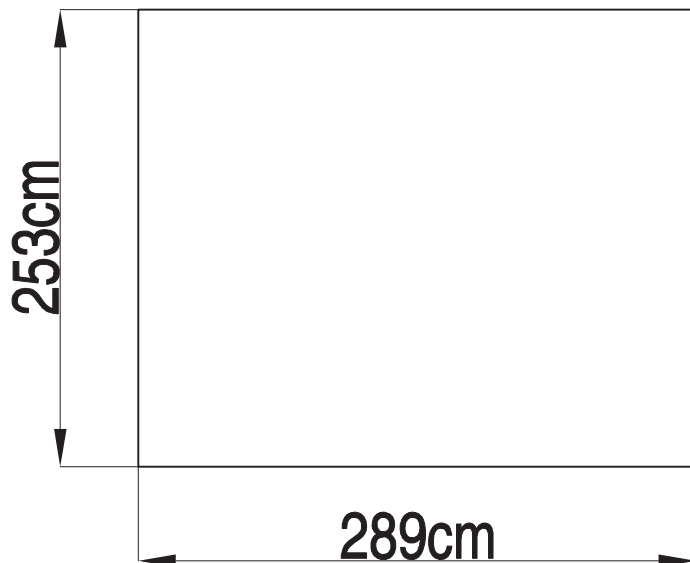
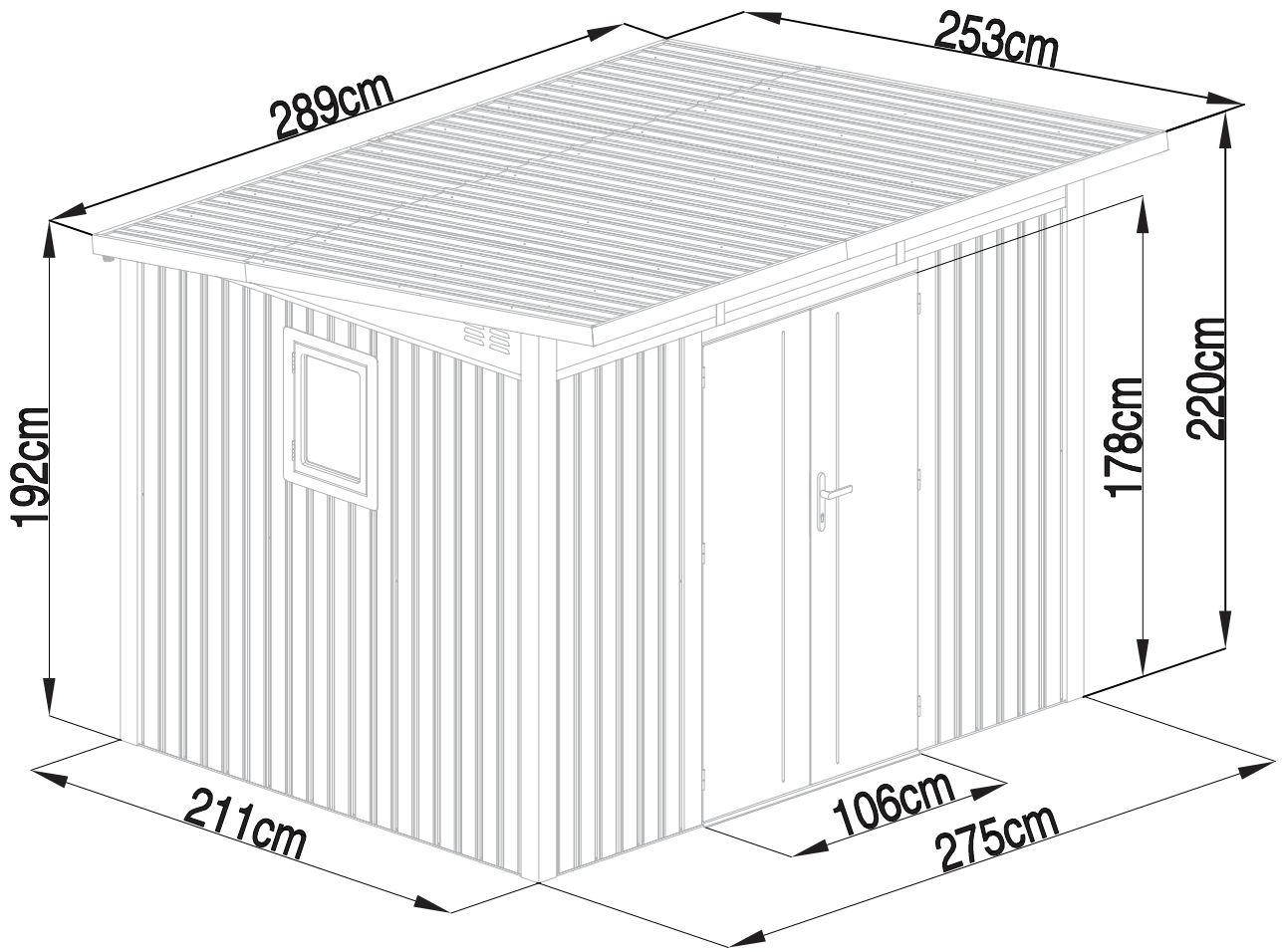



1. Entretien à l'eau et au savon.
2. Afin d'assurer le bon coulissement de la porte, veuillez garder le rail de porte propre.
3. L'accumulation de neige peut entraîner l'effondrement du toit. Veuillez donc à retirer régulièrement la neige qui se sera accumulée sur le toit.
4. Cet abri est uniquement réservé à l'usage de stockage. Il ne peut servir comme pièce d'habitation ou autre usage en dehors de celui de stockage.







KIS12120



NO.	IMAGE	mm	QTY	
UNDER				
Ana-C1		1458	x1	
Ana-C1a		1245	x1	
Ana-C2		1371.5	x1	
Ana-C2a		1331.5	x1	
Ana-B3		2064	x2	
Ana-A4			1130	x1
MIDDLE				
Ac-A5		1900	x2	
Anx-A5		2152	x1	
Anx-A5a		2152	x1	
Ac-A6		1900	x11	
Ac-A7		1900	x1	
Ana-C9		1521.5	x1	
Ana-C9a		1191.5	x1	
Ana-B10		2063	x2	
Ana-C11		783.5	x2	
Ac-C12		1531.5	x1	
Ac-C12a		1181.5	x1	
Ana-C13		1521.5	x1	
Ana-C13a		1191.5	x1	
Anx-B14		2063	x2	
Ana-A15			1900	x1
Ana-A15a			1900	x1
Ana-A16			1900	x1
Ana-A16a			1900	x1
Ana-A17			1087.5	x1
Ana-C18		904.5	x2	
Ana-C18a		1811.5	x2	
Ac-C18		1299.5	x1	
Ac-C18a		1299.5	x1	
Anx-B20		2019	x2	
Ana-C21		190	x1	
Anx-B21		1999	x1	
Anx-B21a		1999	x1	
Anx-B22		161	x2	
Anx-B22a		81	x2	
Ana-C22		223	x2	
Ana-A22a		223	x2	
Anx-C22		70	x1	

NO.	IMAGE	mm	QTY
Anx-C23		2079.5	x2
Anx-C23a		737	x2
Anx-D23		1812	x1
Anx-D23a		903	x1
Ana-C36		890	x3
Ana-C33		272	x2
DOOR			
Ac-A29		1804	x1
Ac-A29a		1804	x1
TOP			
Anx-B24		1823.5	x1
Anx-B24a		785	x1
Anx-B25		1823.5	x3
Anx-B25a		1823.5	x1
Anx-B25b		785	x3
Anx-B25c		785	x1
Anx-A27		1296.9	x1
Anx-C27a		1616.4	x1
Anx-B28		1760	x2
Anx-B28a		794	x1
Anx-B28b		794	x1
Anx-C26		1447	x1
Anx-C26a		1447	x1
ANNEX			
Ana-P1			x2
Anx-26		90	x1
Ab-4			x12
Anx-C37			5.3M
Ana-P6			x1
Ana-P7			x1
Ana-P8			x1
Ab-50			x6
Ana-54			x1
Ana-55			x1
Ana-56			x1
Ana-57			x1
Ana-58		M5x45	x3
Anx-C40			x216
Anx-C41		ST4x10	x351

NO.	IMAGE	mm	QTY
Ana-A42		ST4x10	x2
Anx-C42		M6x12	x2
Anx-A43		M4x10	x18
Anx-A44		M5x8	x4
Anx-C45		ST4x25	x17
Anx-C46		M4x10	x17
Anx-C47		ST4x16	x4
Anx-C48		M6x25	x6

1	 Ana-C1 x1	 Ana-C1a x1	 Ana-C2 x1	 Ana-C2a x1	 Ana-B3 x2	 Ana-C21 x1	 Anx-C41 x8
---	--	---	--	---	---	---	---

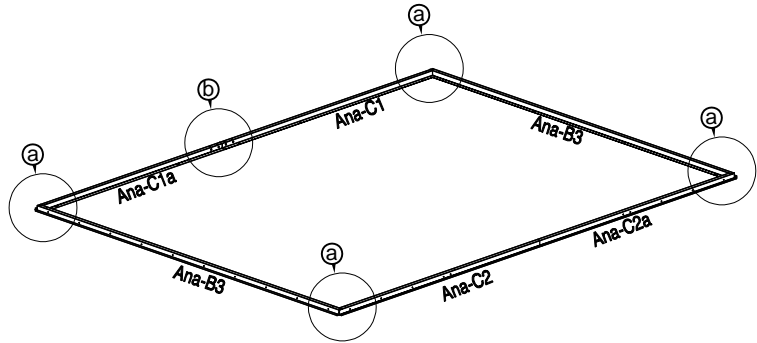
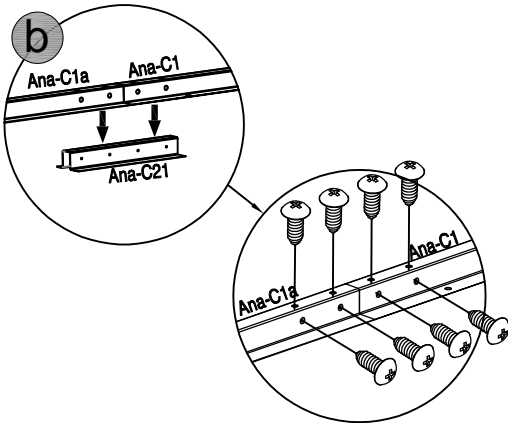
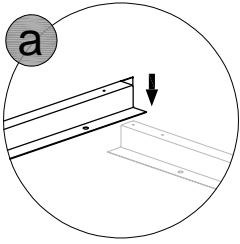

2	 Ab-4 x4	 Anx-C41 x12	
---	--	--	--

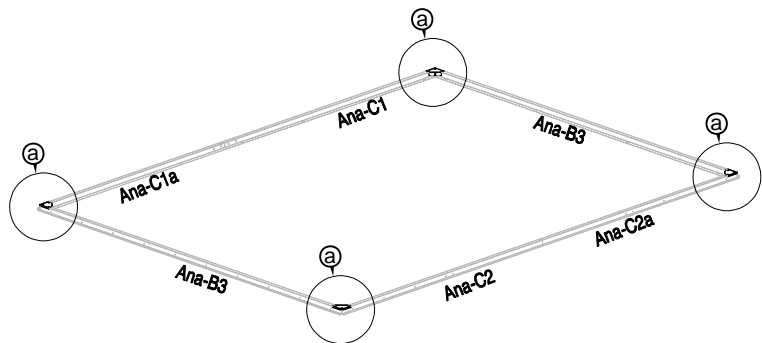
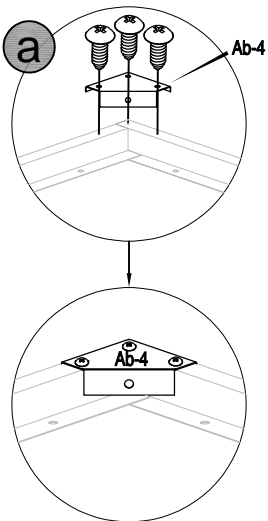

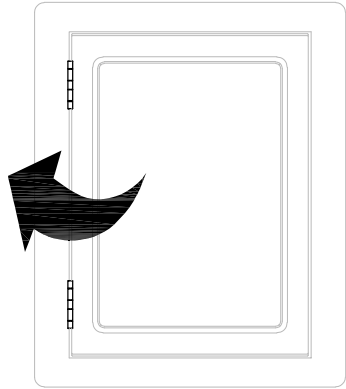



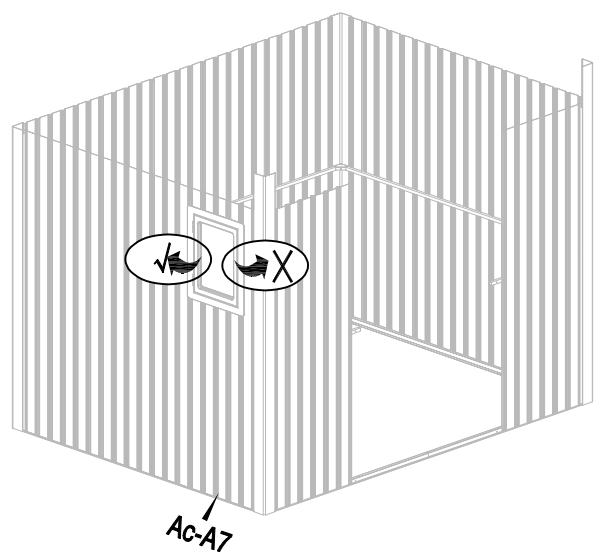
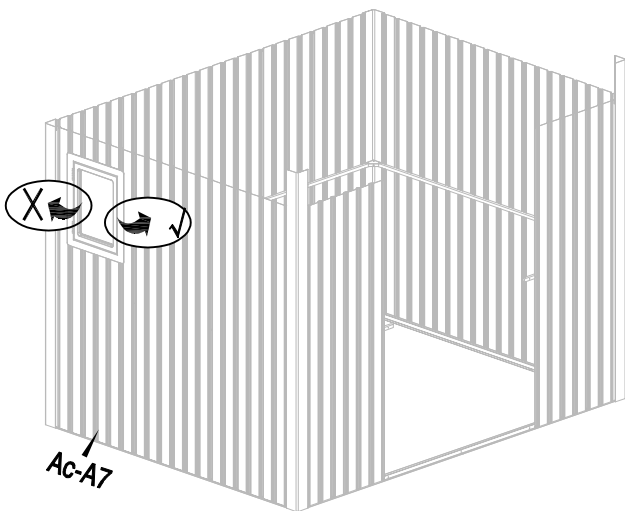
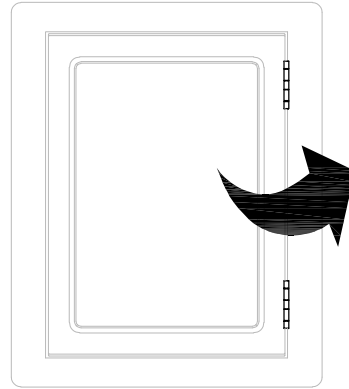

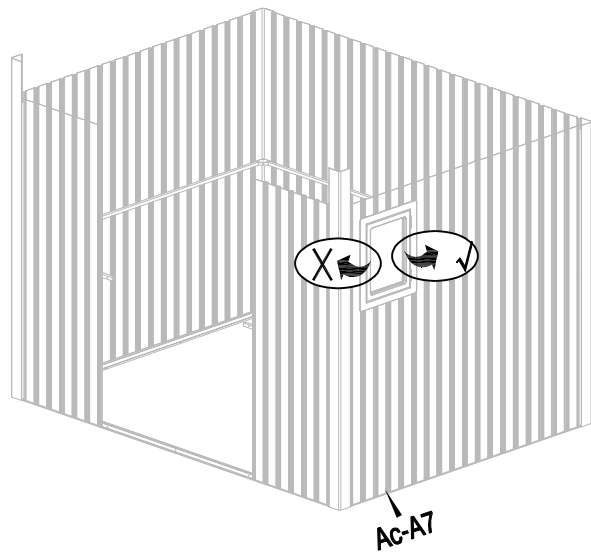
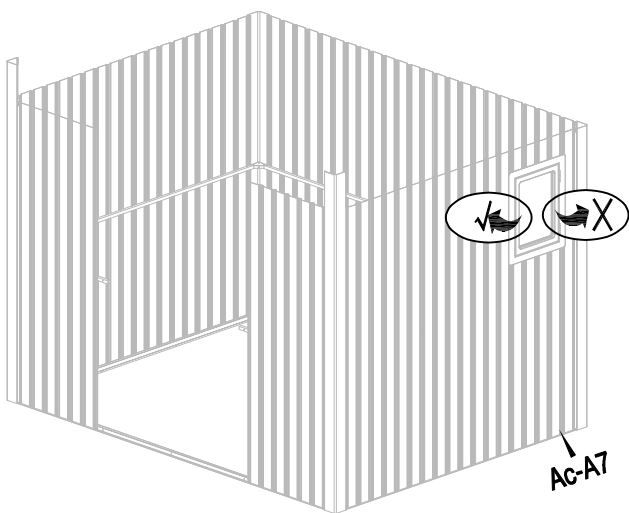
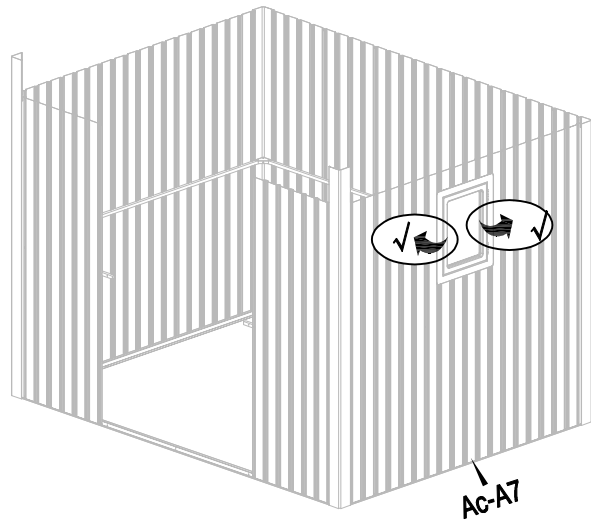
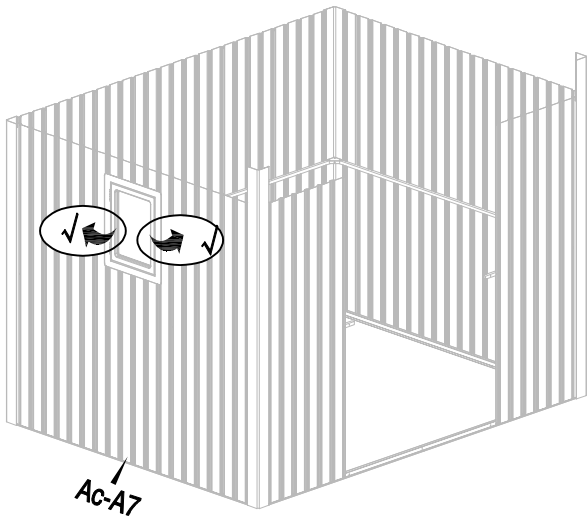



Or



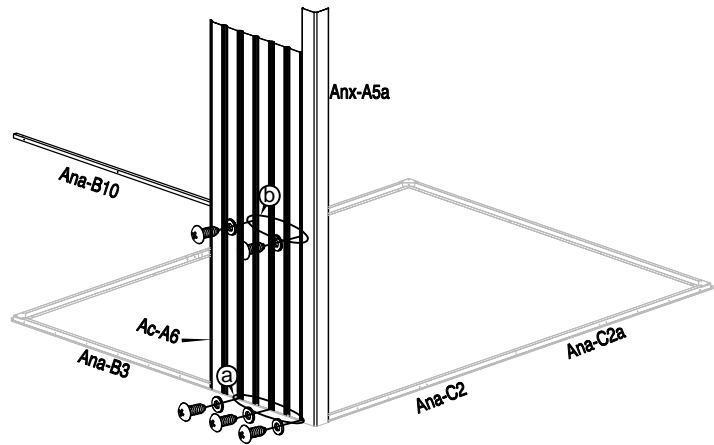
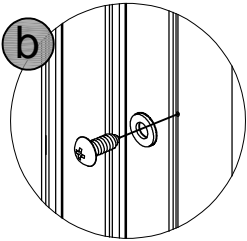
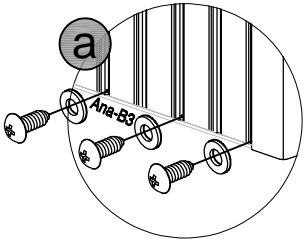
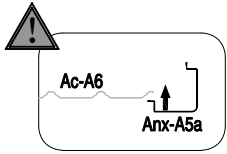





3	 Ac-A6 x1	 Anx-A5a x1	 Ana-B10 x1	 Anx-C41 x5	 Anx-C40 x5	
----------	---	---	---	--	---	--

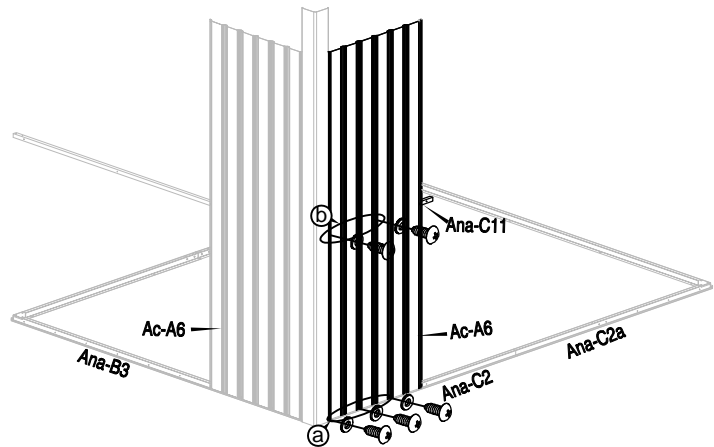
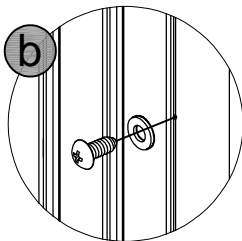
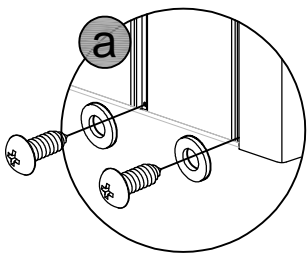





4	 Ac-A6 x1	 Ana-C11 x1	 Anx-C41 x5	 Anx-C40 x5		
----------	---	---	---	--	--	--

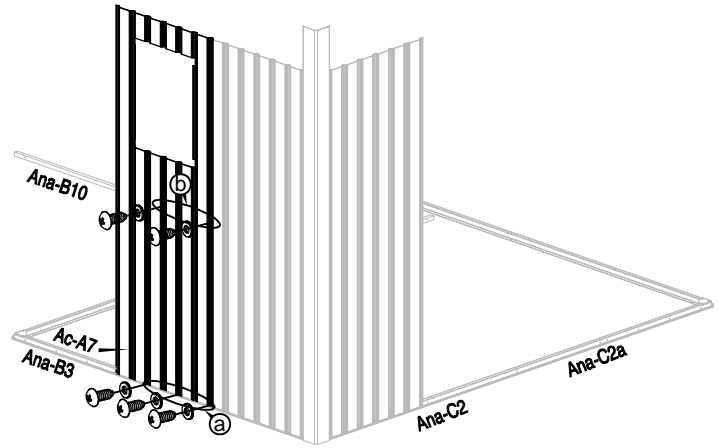
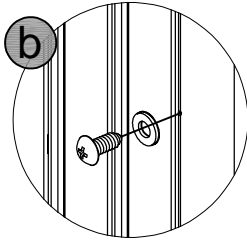
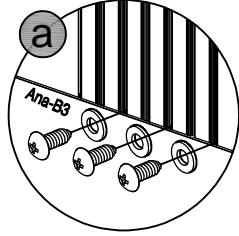





5	 <p>Ac-A7 x1</p>	 <p>Anx-C41 x5</p>	 <p>Anx-C40 x5</p>	
---	---	---	---	--

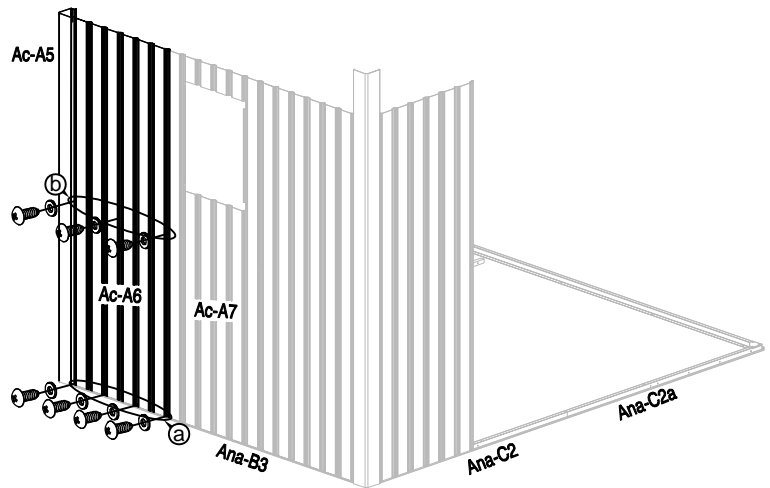
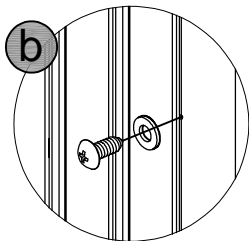
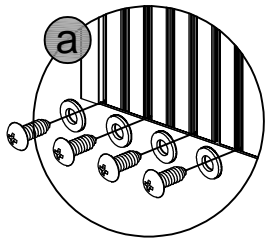





6	 <p>Ac-A6 x1</p>	 <p>Ac-A5 x1</p>	 <p>Anx-C41 x7</p>	 <p>Anx-C40 x7</p>	
---	---	---	---	--	--

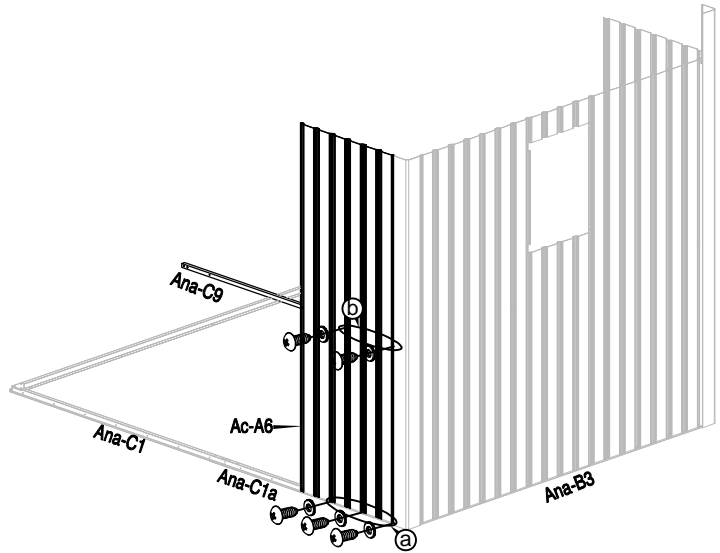
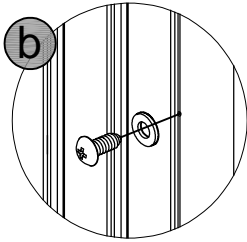
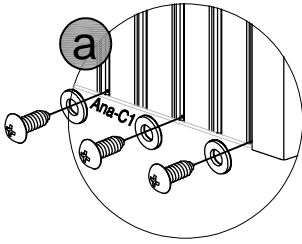



7	 Ac-A6 x1	 Ana-C9 x1	 Anx-C41 x5	 Anx-C40 x5	
---	---	--	---	--	--



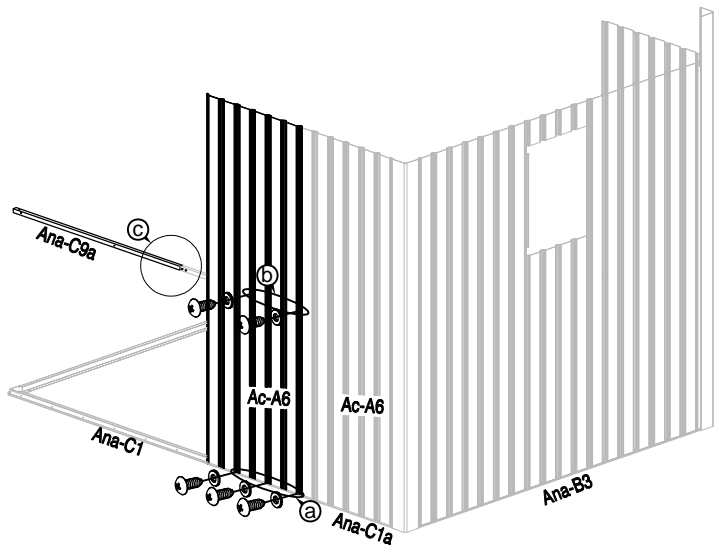
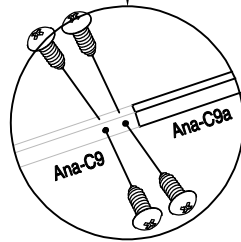
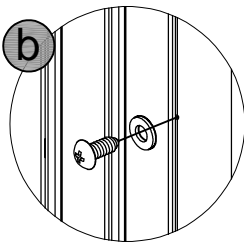
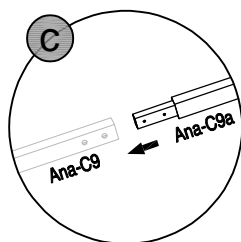
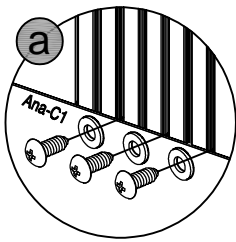



8	 Ac-A6 x1	 Ana-C9a x1	 Anx-C41 x9	 Anx-C40 x5	
---	---	---	---	--	--

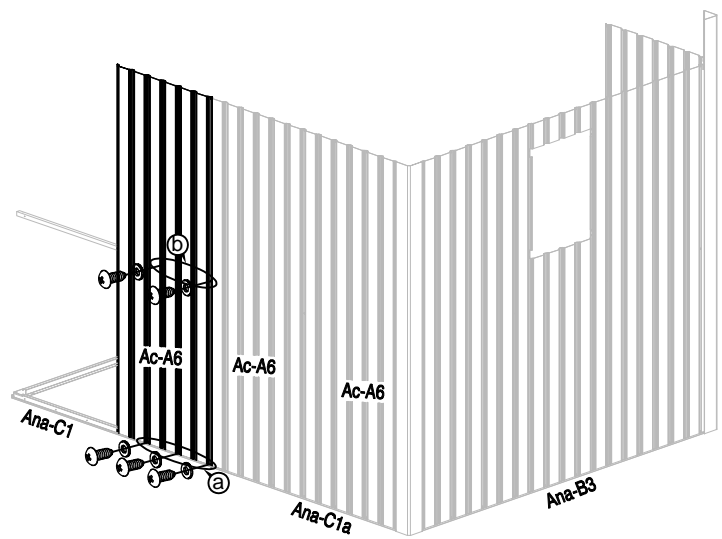
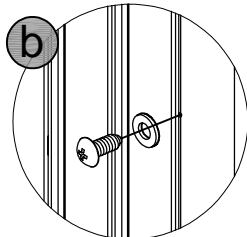
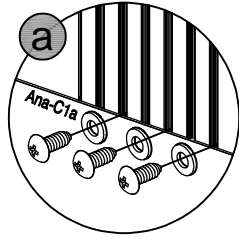

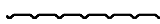



9	 Ac-A6 x1	 Anx-C41 x5	 Anx-C40 x5	
---	---	---	---	--

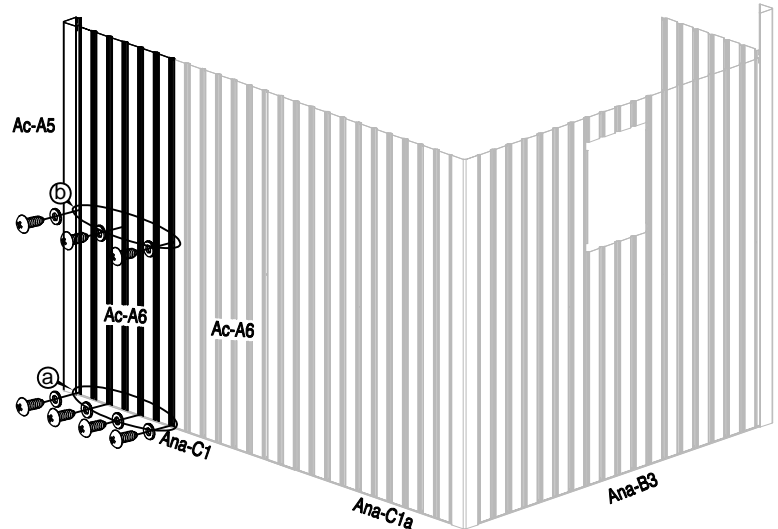
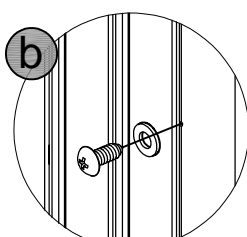
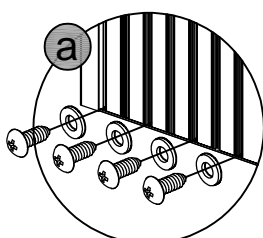



10	 Ac-A6 x1	 Ac-A5 x1	 Anx-C41 x7	 Anx-C40 x7	
----	---	---	---	--	--



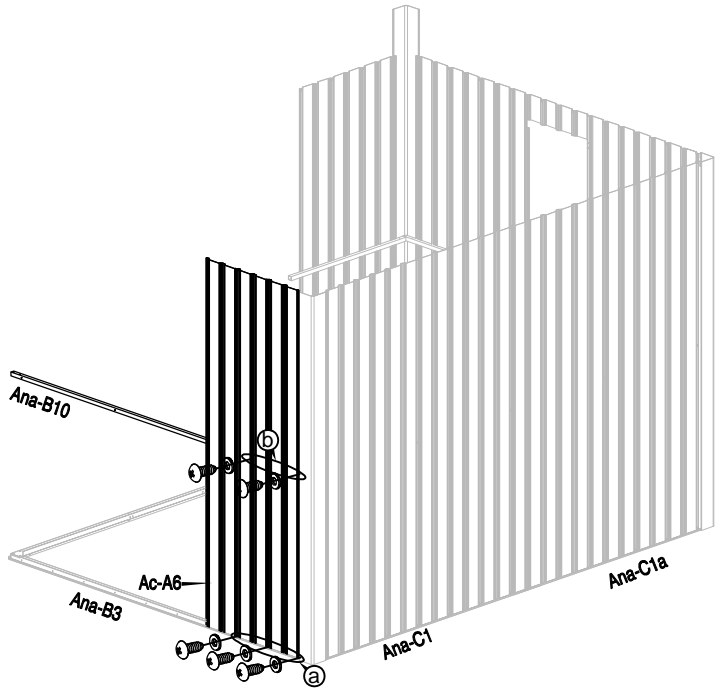
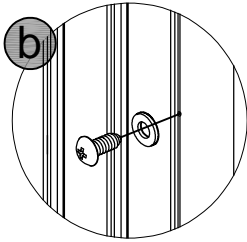
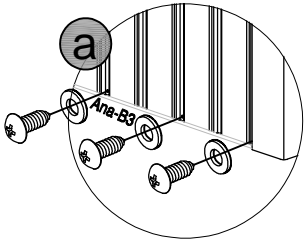



11	 Ac-A6 x1	 Ana-B10 x1	 Anx-C41 x5	 Anx-C40 x5	
----	---	---	---	--	--

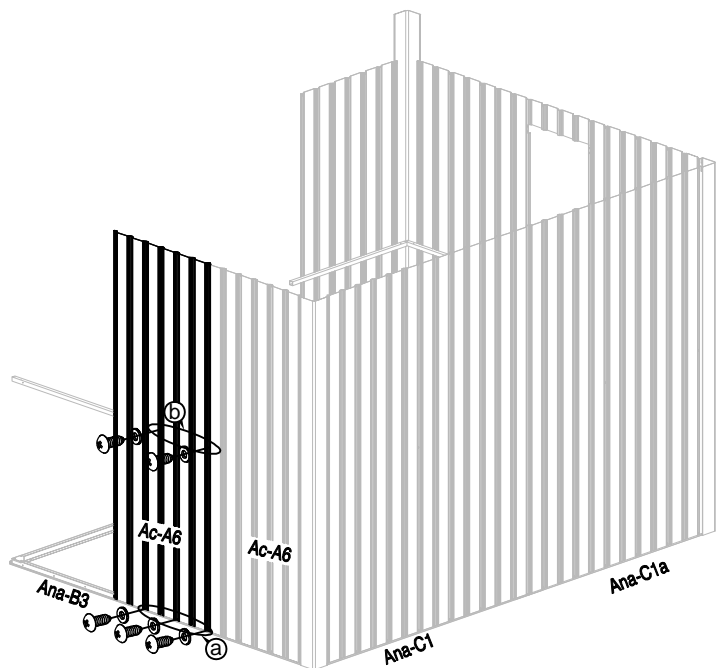
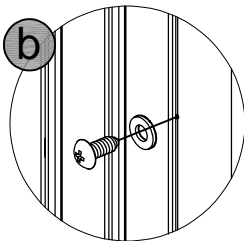
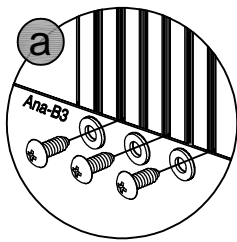





12	 Ac-A6 x1	 Anx-C41 x5	 Anx-C40 x5	
----	---	---	---	--

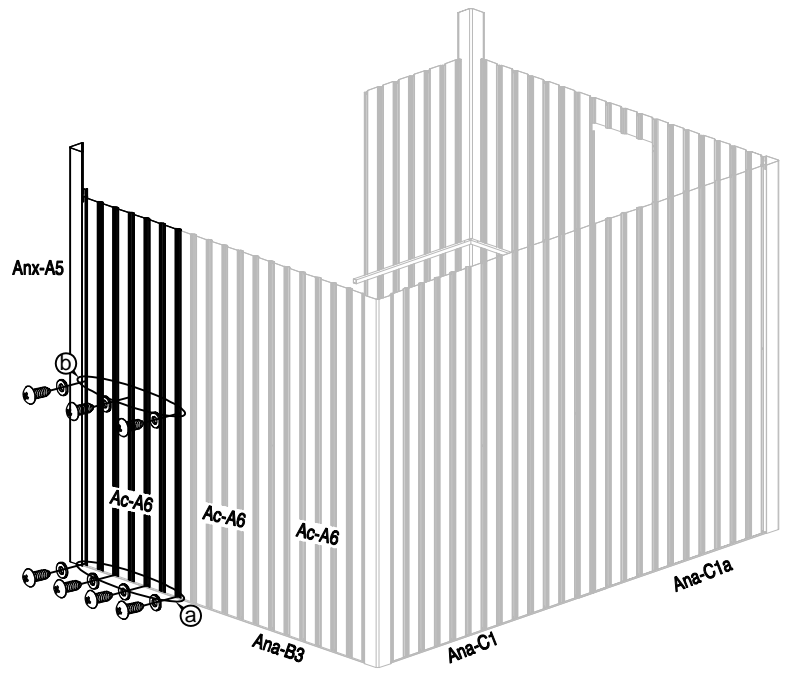
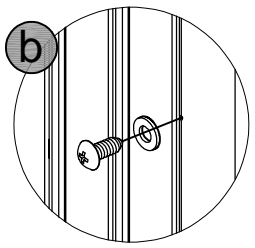
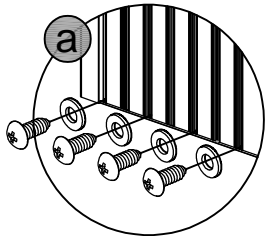

13	 Ac-A6 x1	 Anx-A5 x1	 Anx-C41 x7	 Anx-C40 x7	
----	---	--	---	--	--





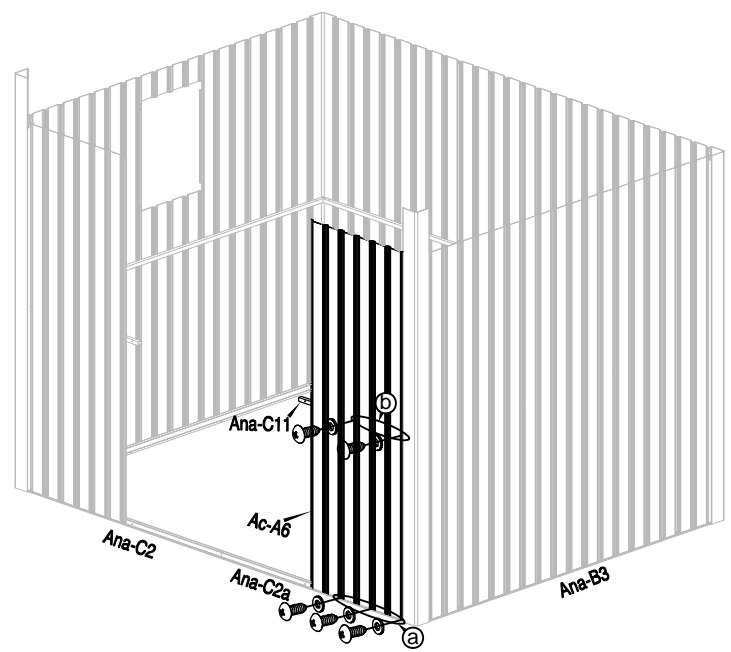
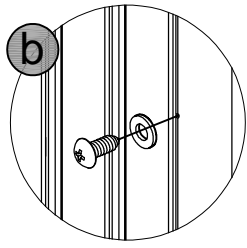
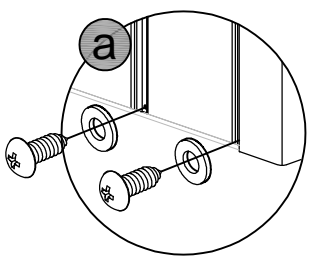

14	 Ac-A6 x1	 Ana-C11 x1	 Anx-C41 x5	 Anx-C40 x5	
----	---	---	---	--	--

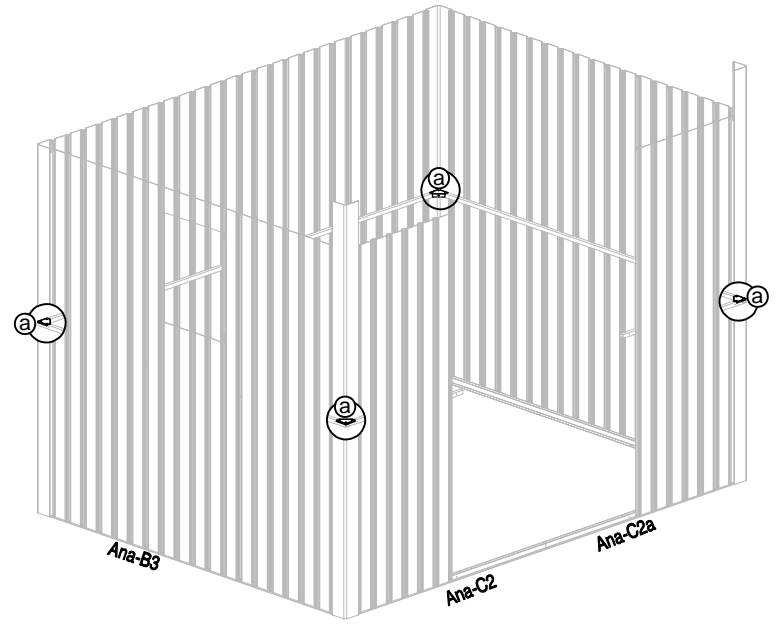
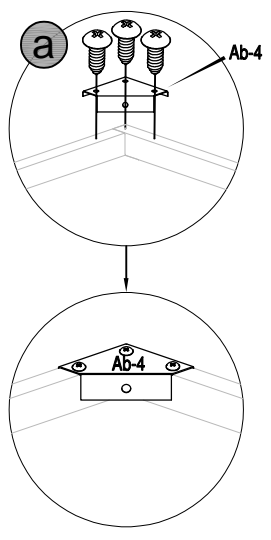

15	 Ab-4 x4	 Anx-C41 x12	
----	--	--	--



16	 Anx-B14 x1	 Ana-C13 x1	 Ana-C13a x1	 Anx-C41 x20	 Anx-C40 x16	
----	---	---	--	---	--	--

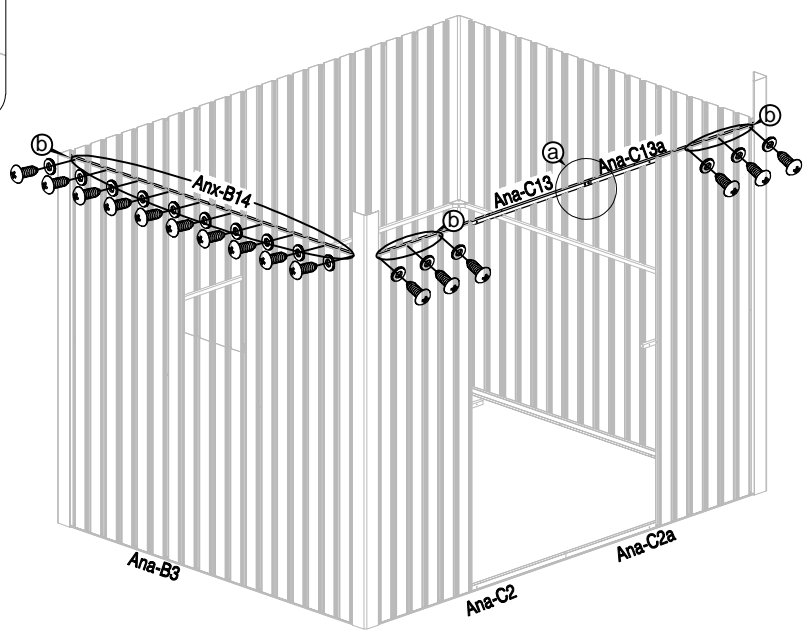
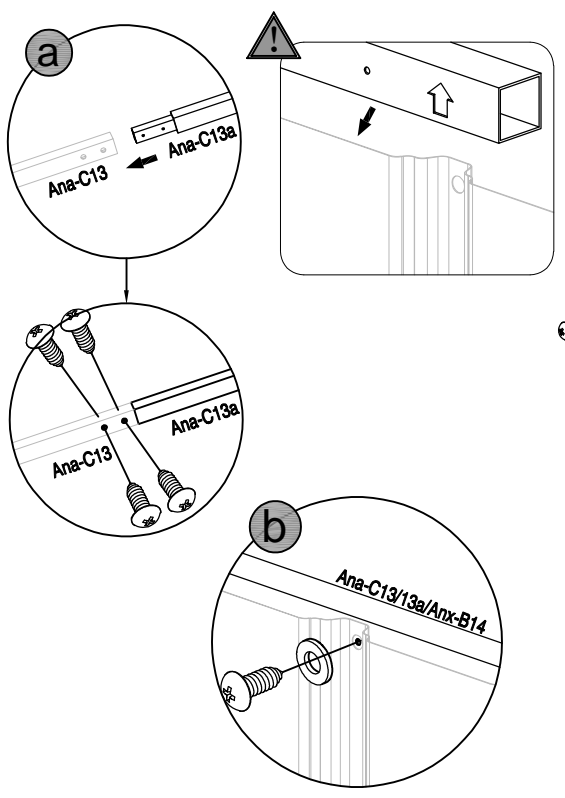

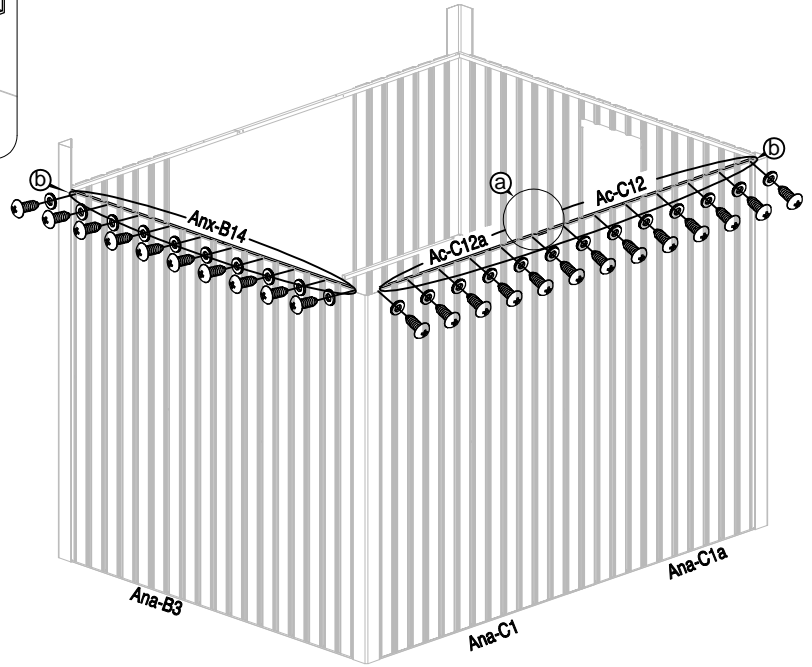
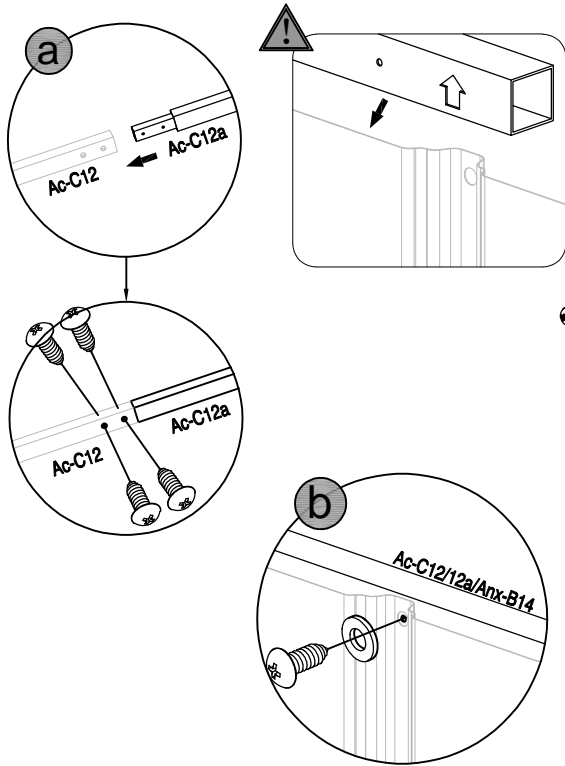

17	Anx-B14 x1	Ac-C12 x1	Ac-C12a x1	Anx-C41 x27	Anx-C40 x23	
----	------------	-----------	------------	-------------	-------------	--



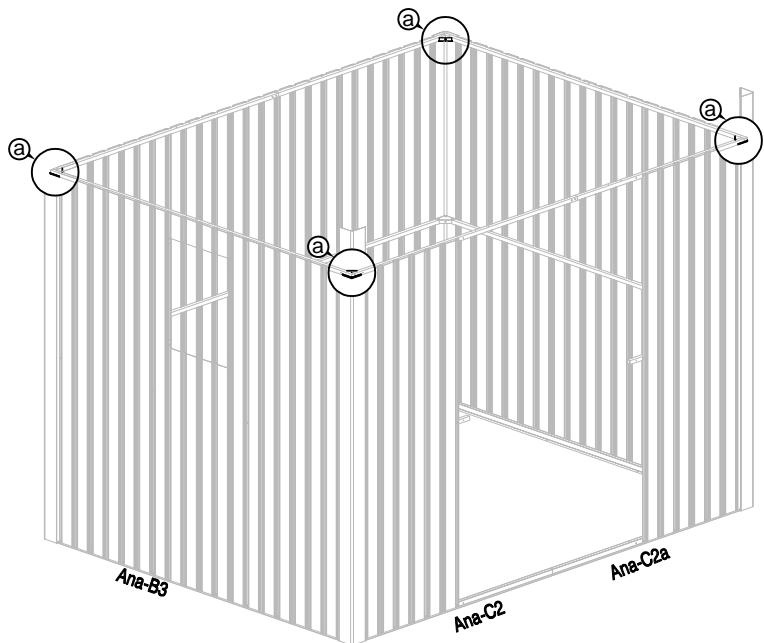
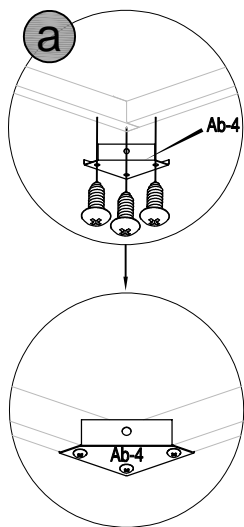

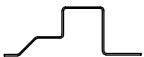
18	Ab-4 x4	Anx-C41 x12	
----	---------	-------------	--



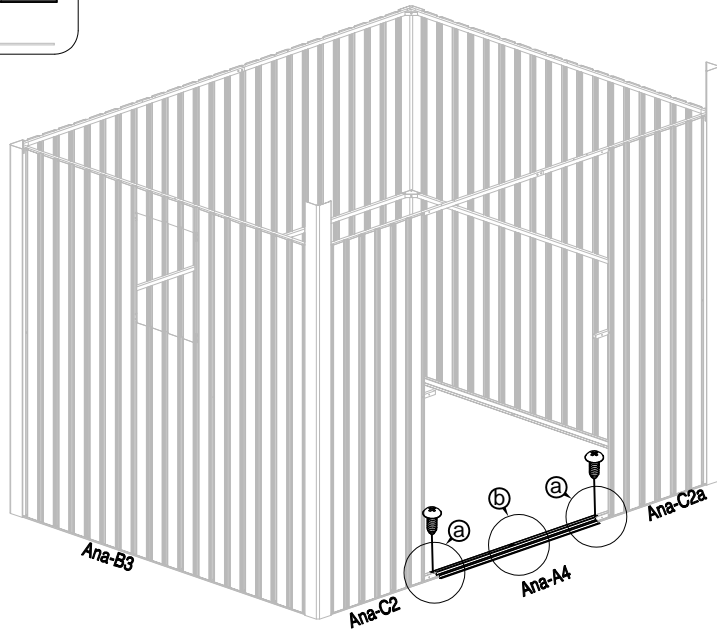
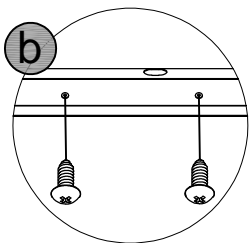
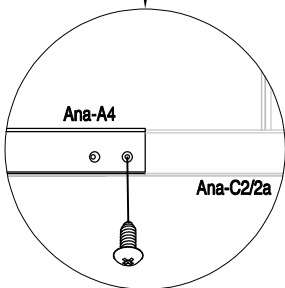
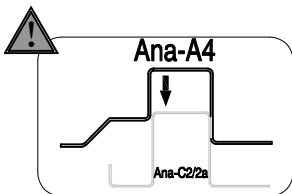
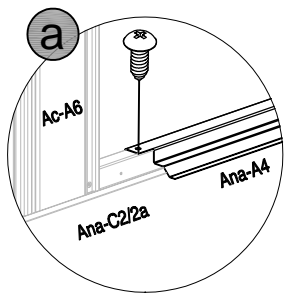



19	 Ana-A4 x1	 Anx-C41 x6	
----	--	---	--

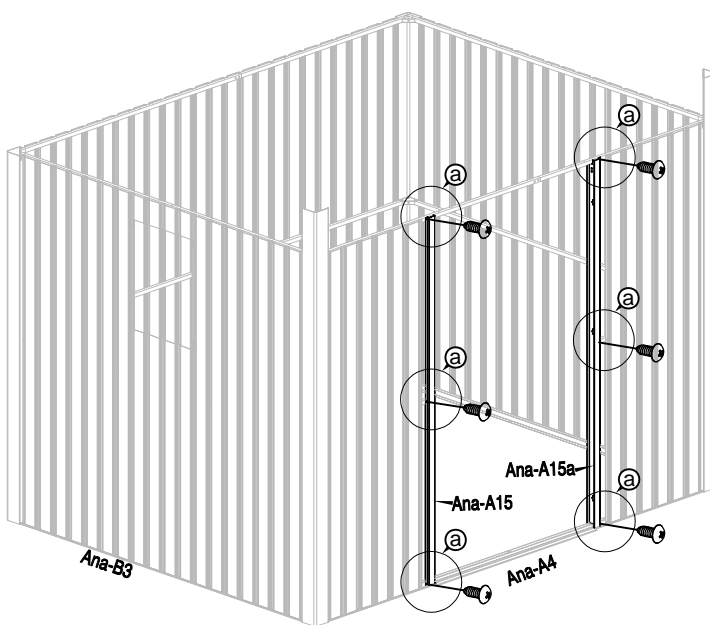
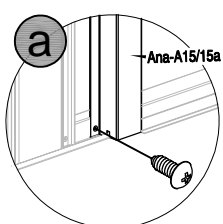
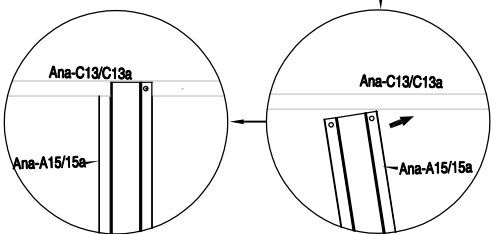
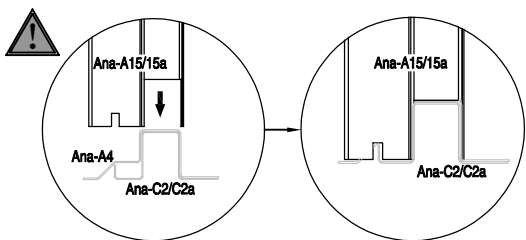

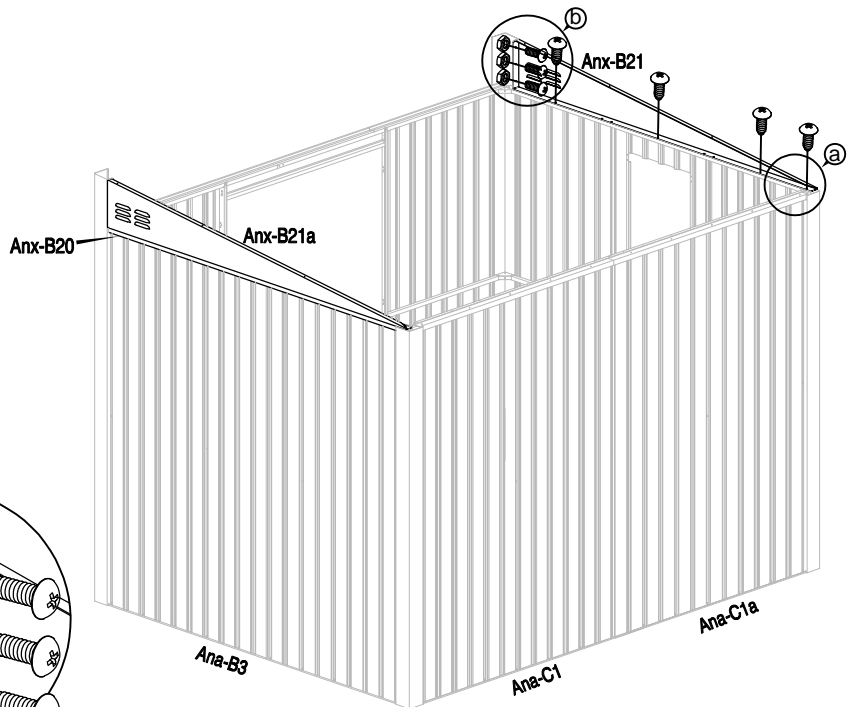
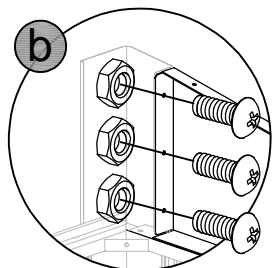
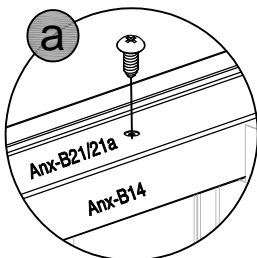
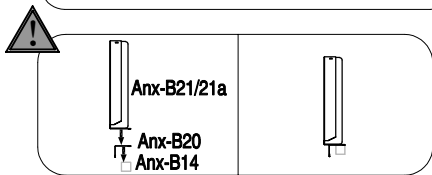
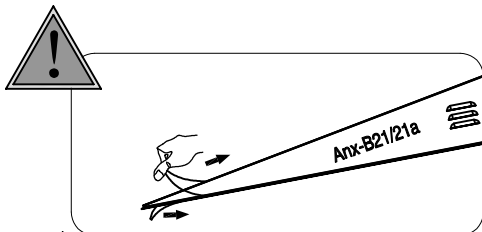
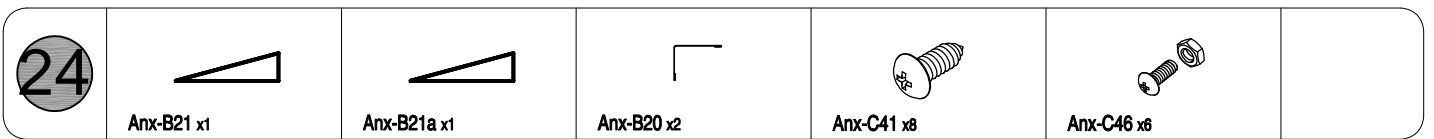
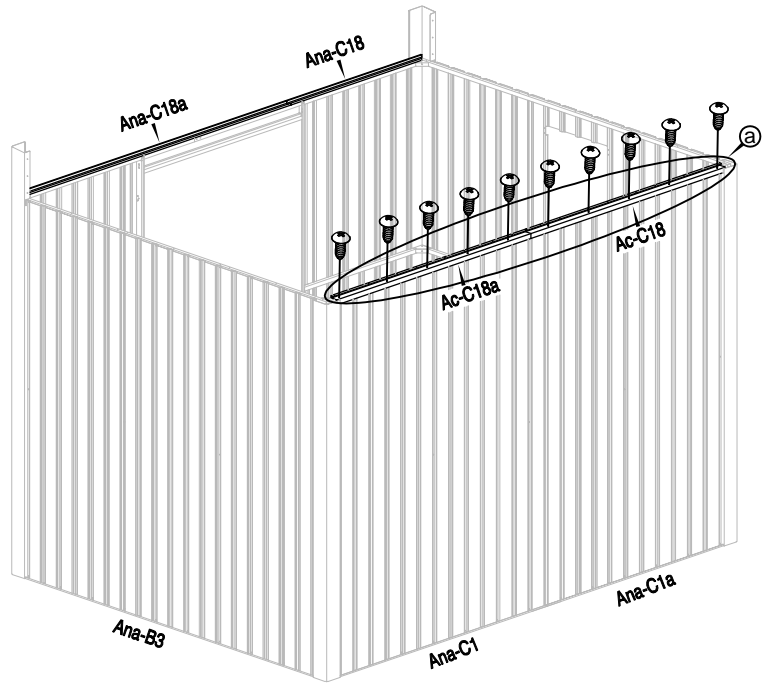
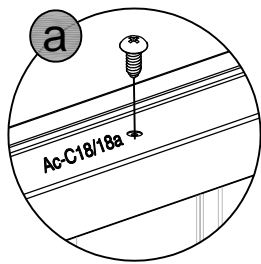
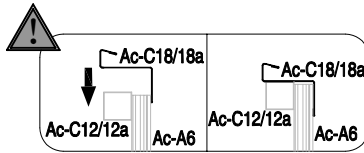
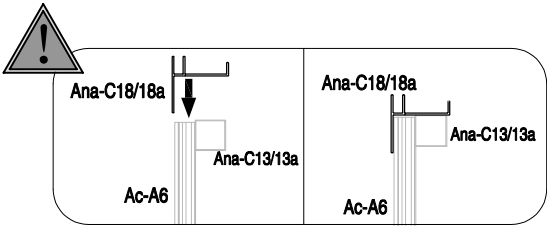
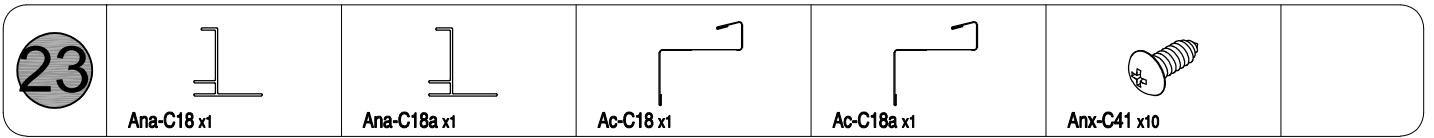
20	 Ana-A15 x1	 Ana-A15a x1	 Anx-C41 x6	
----	---	--	---	--



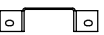

25	 Anx-B22 x2	 Anx-B22a x2	 Ana-C22 x2	 Ana-A22a x2	 Anx-C41 x16	
----	---	--	---	--	--	--

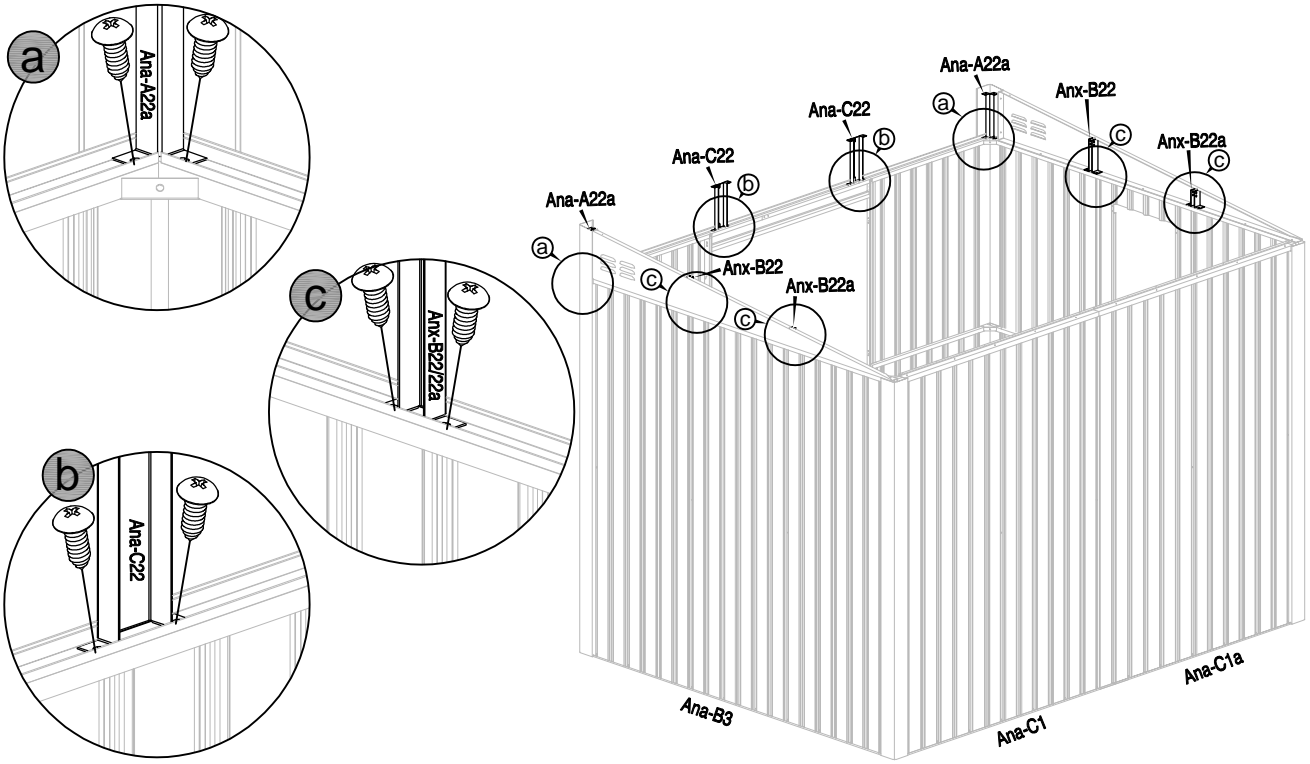

26	 Ana-C33 x2	 Anx-C42 x2	
----	---	---	--

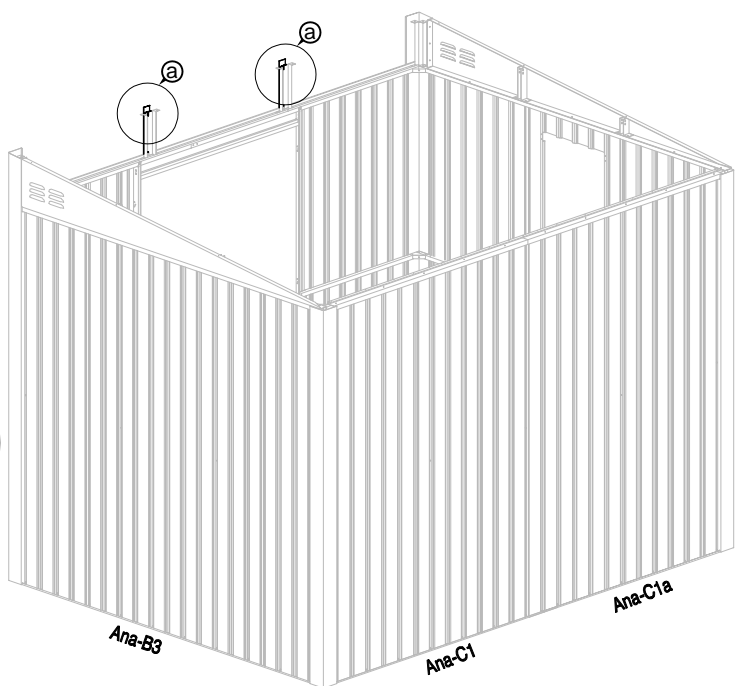
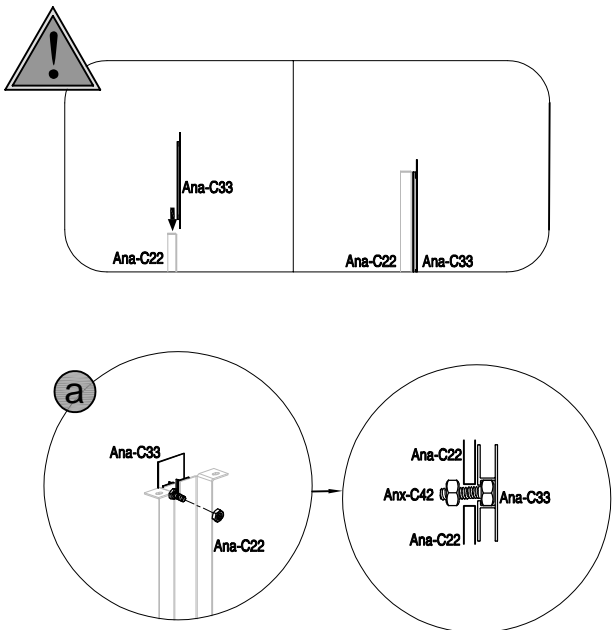

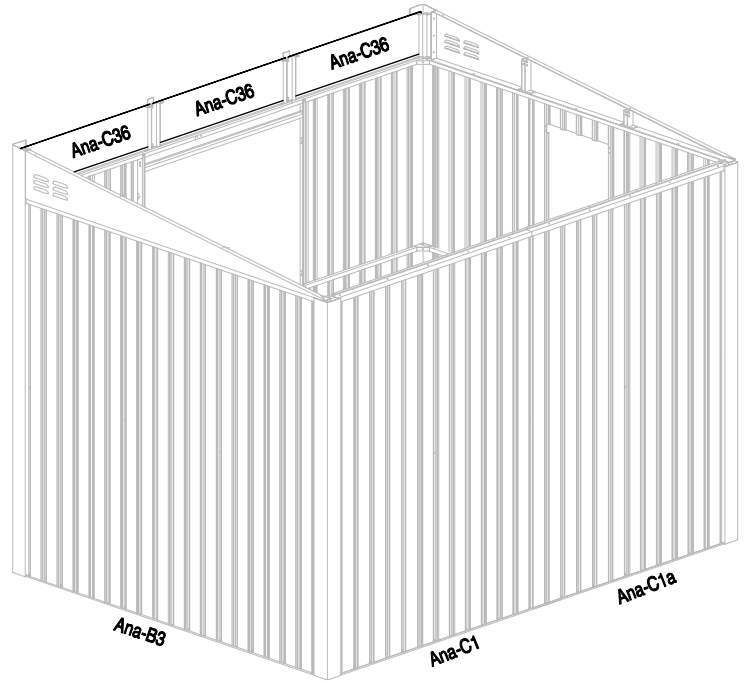
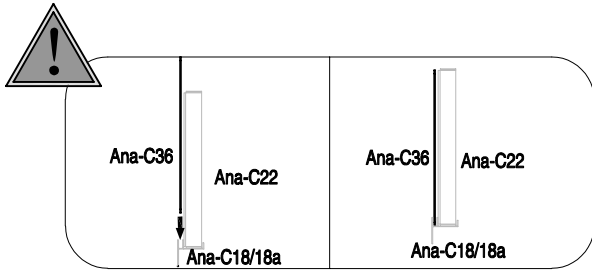
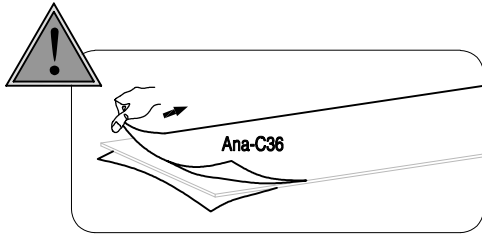

<div style="border: 1px solid black; border-radius: 50%; width: 40px; height: 40px; display: flex; align-items: center; justify-content: center; margin: 0 auto;">27</div>		
--	---	--



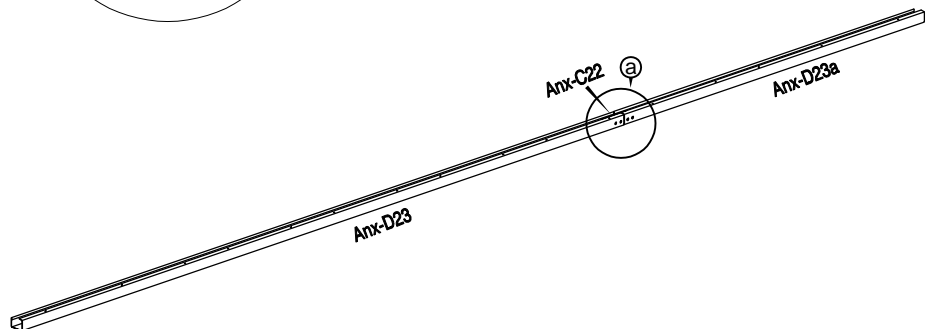
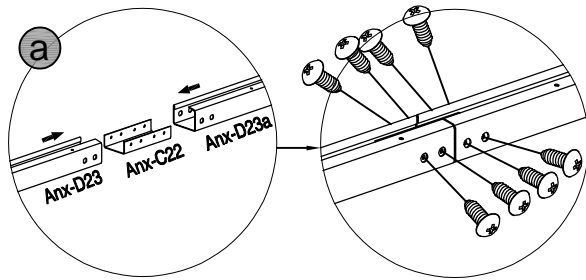

<div style="border: 1px solid black; border-radius: 50%; width: 40px; height: 40px; display: flex; align-items: center; justify-content: center; margin: 0 auto;">28</div>					
--	---	---	---	--	--



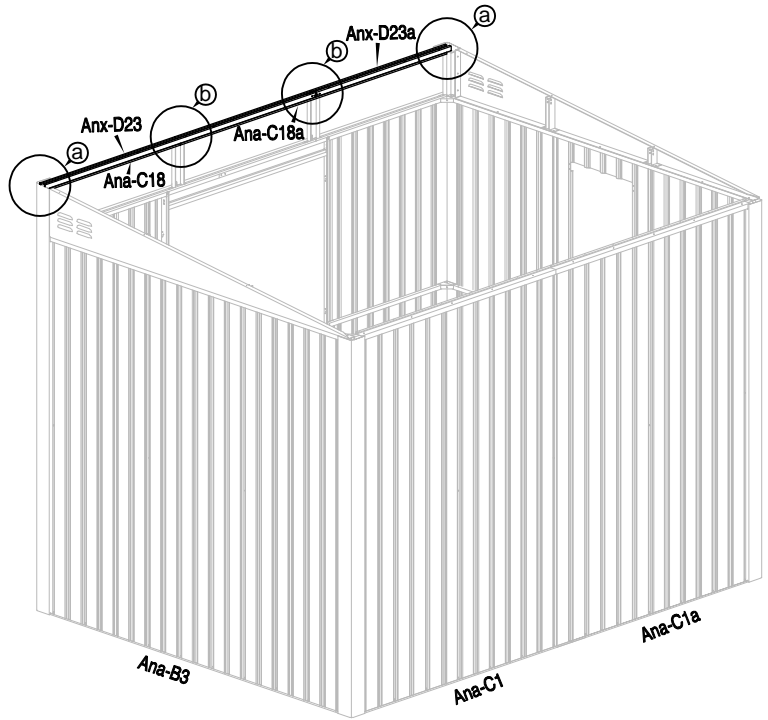
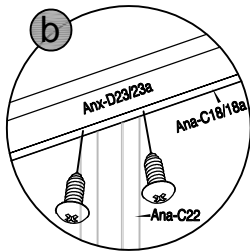
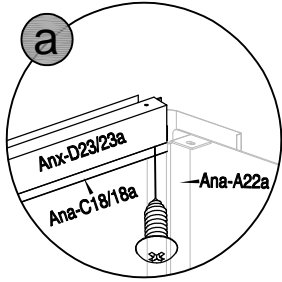
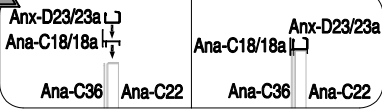

29	 Ana-C18 x1	 Ana-C18a x1	 Ana-C41 x6	
-----------	---	--	---	--

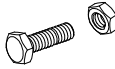

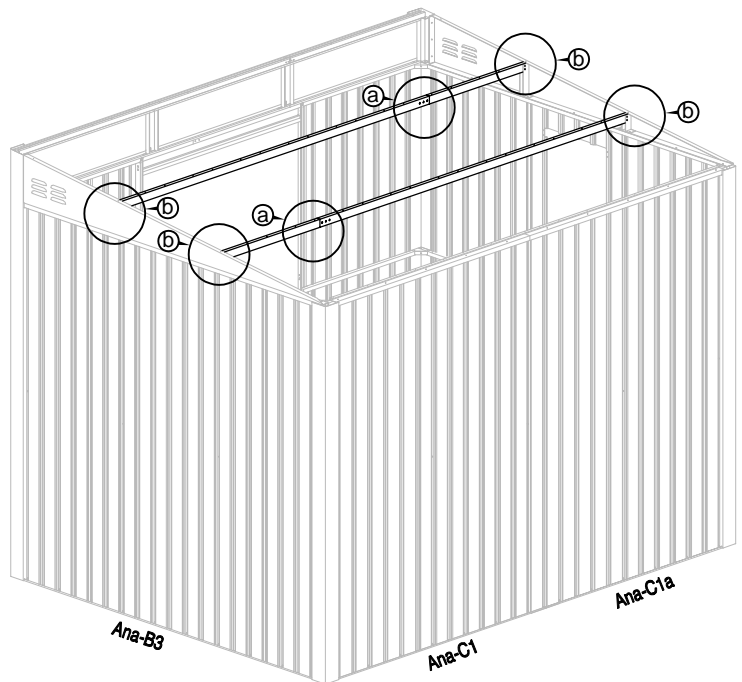
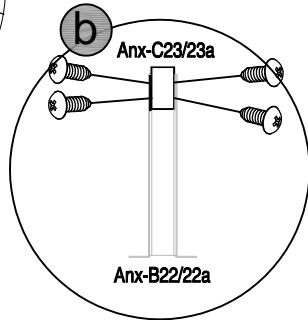
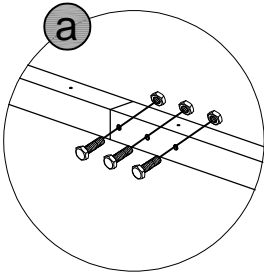
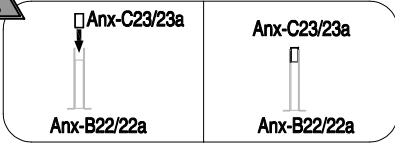

30	 Anx-C23 x2	 Anx-C23a x2	 Ana-C41 x16	 Anx-C48 x6	
-----------	---	--	--	--	--



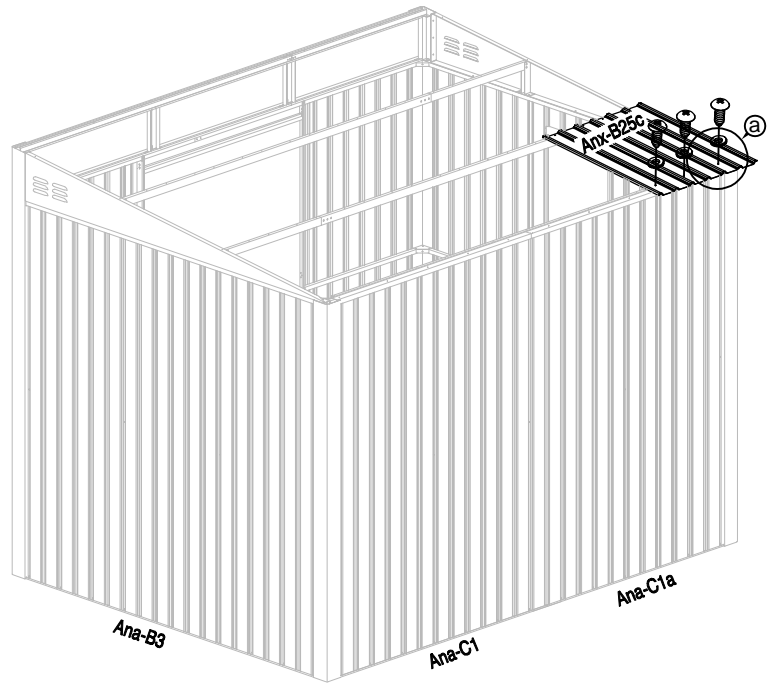
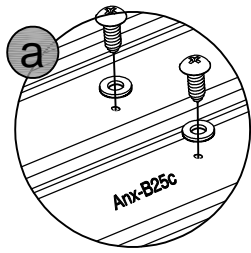

<p>31</p>	 <p>Anx-B25c x1</p>	 <p>Anx-C41 x3</p>	 <p>Anx-C40 x3</p>	
------------------	--	---	---	--



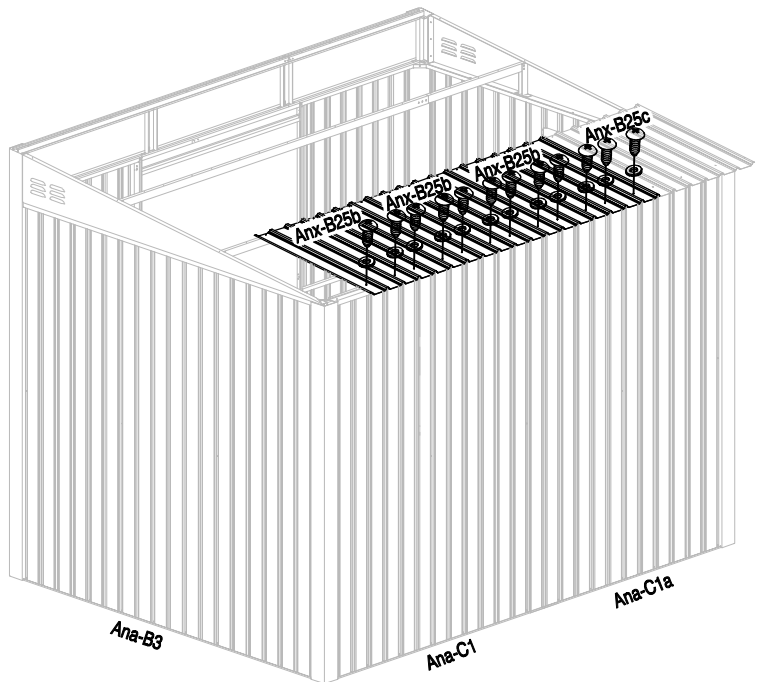
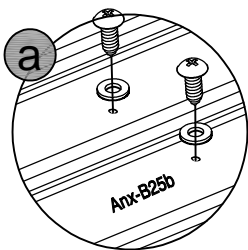
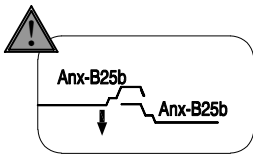
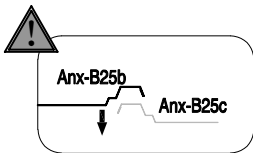



<p>32</p>	 <p>Anx-B25b x3</p>	 <p>Anx-C41 x12</p>	 <p>Anx-C40 x12</p>	
------------------	--	--	--	--

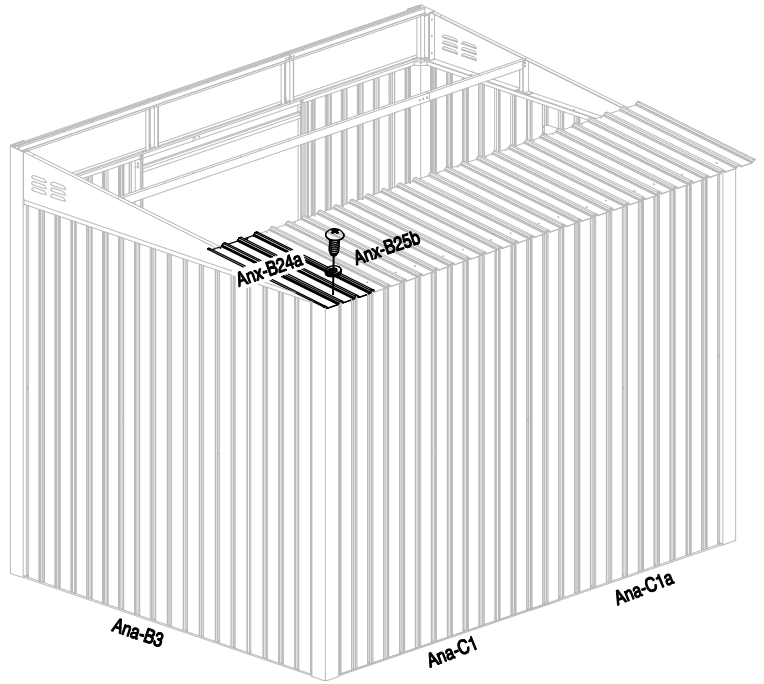
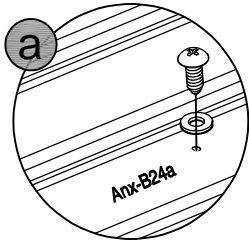
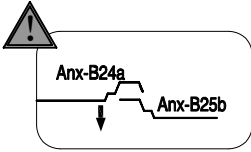





33	 Anx-B24a x1	 Anx-C41 x1	 Anx-C40 x1	
----	--	---	---	--

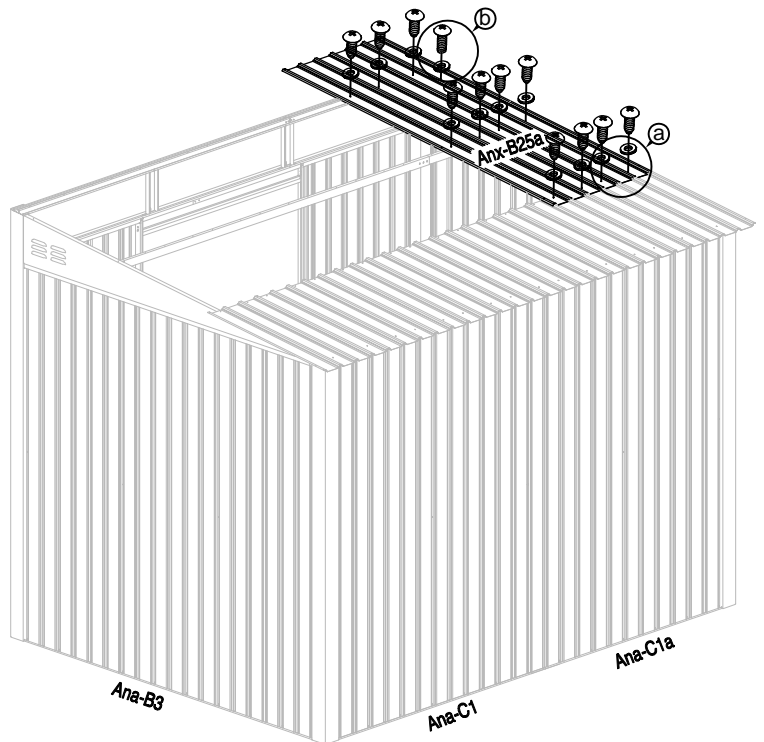
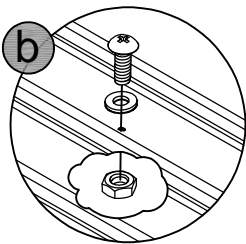
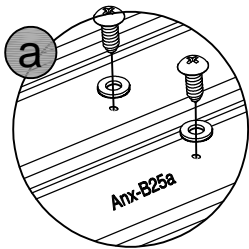





34	 Anx-B25a x1	 Anx-C41 x11	 Anx-C40 x12	 Anx-C46 x1	
----	--	--	--	--	--

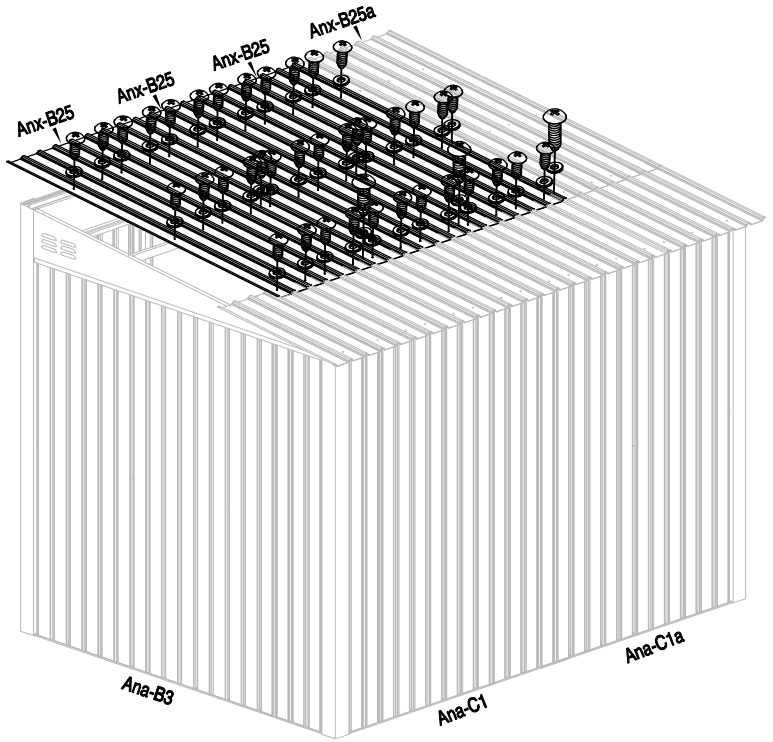
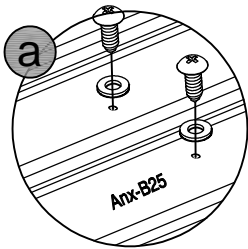
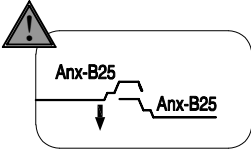
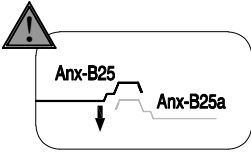

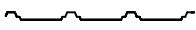
35	 <p>Anx-B25 x3</p>	 <p>Anx-C41 x39</p>	 <p>Anx-C40 x42</p>	 <p>Anx-C47 x3</p>	
----	---	--	--	--	--



36	 <p>Anx-B24 x1</p>	 <p>Anx-C41 x6</p>	 <p>Anx-C40 x8</p>	 <p>Anx-C46 x1</p>	 <p>Anx-C47 x1</p>
----	---	---	---	--	---

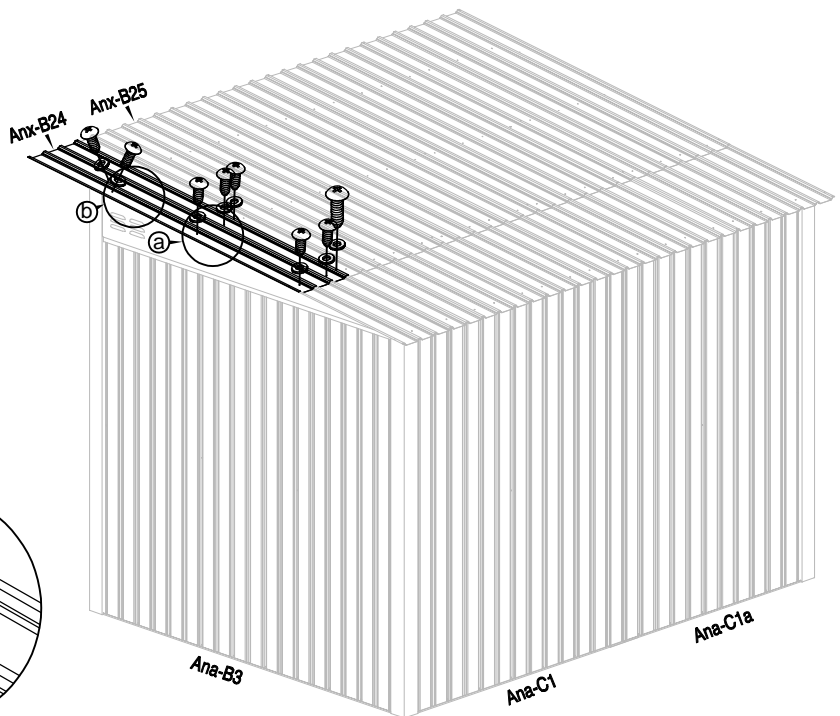
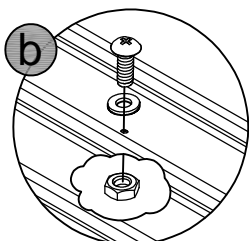
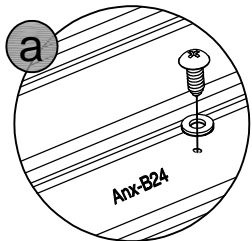
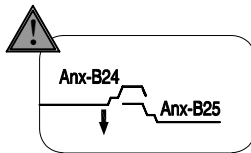



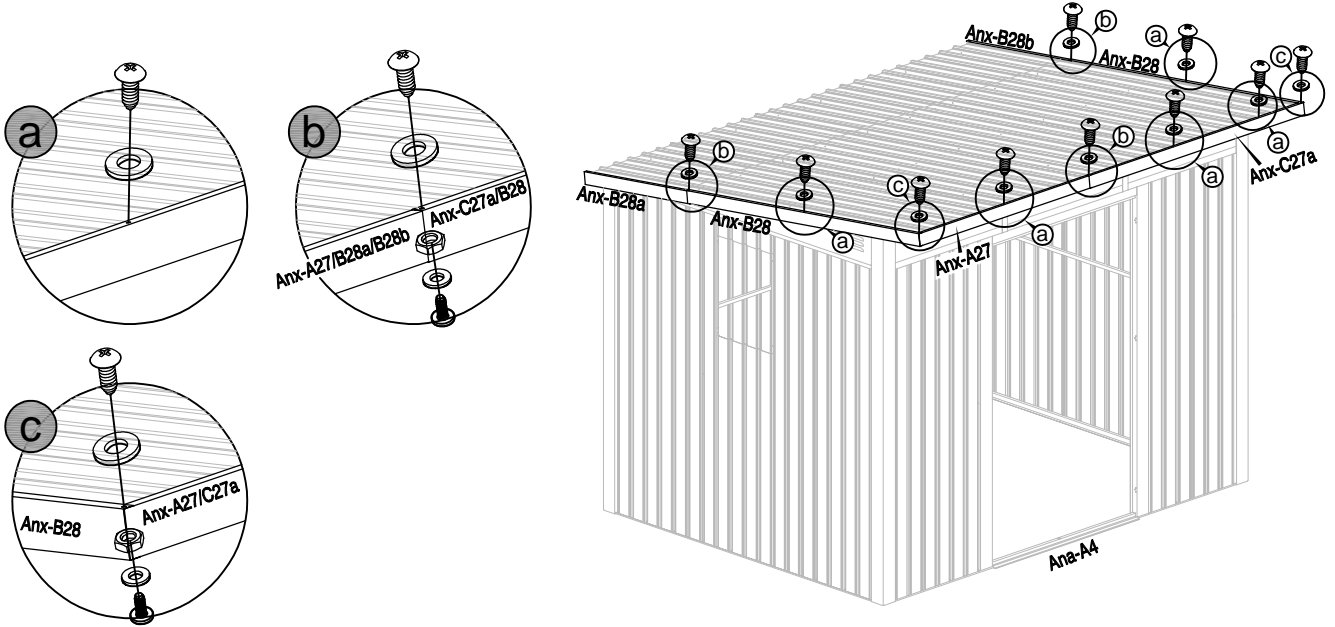
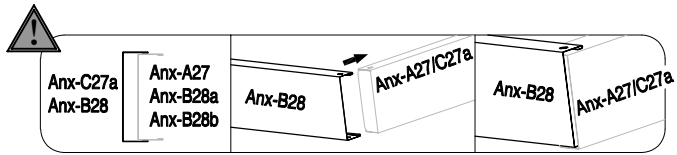



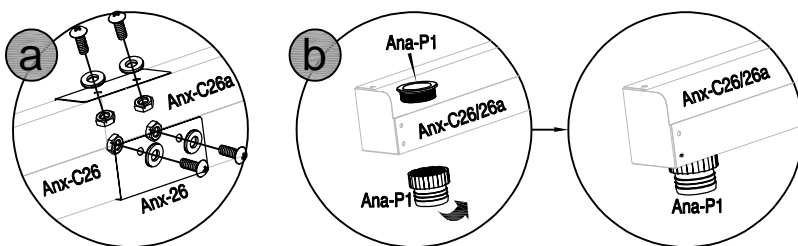
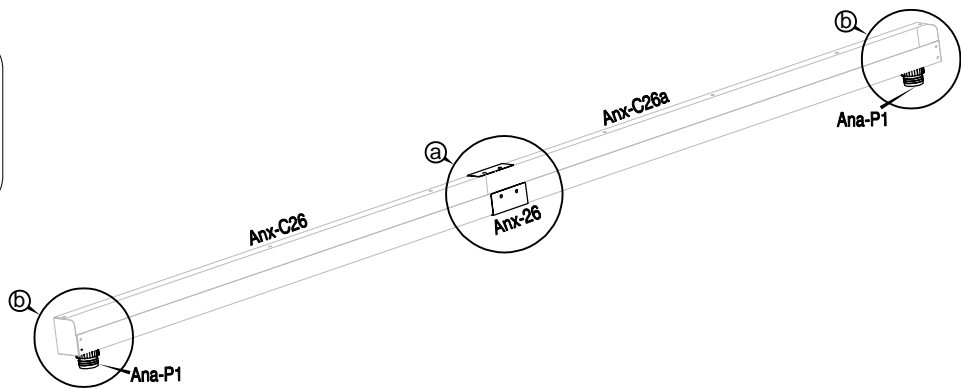
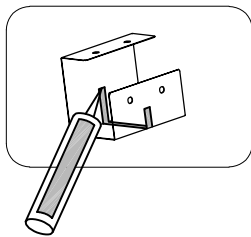

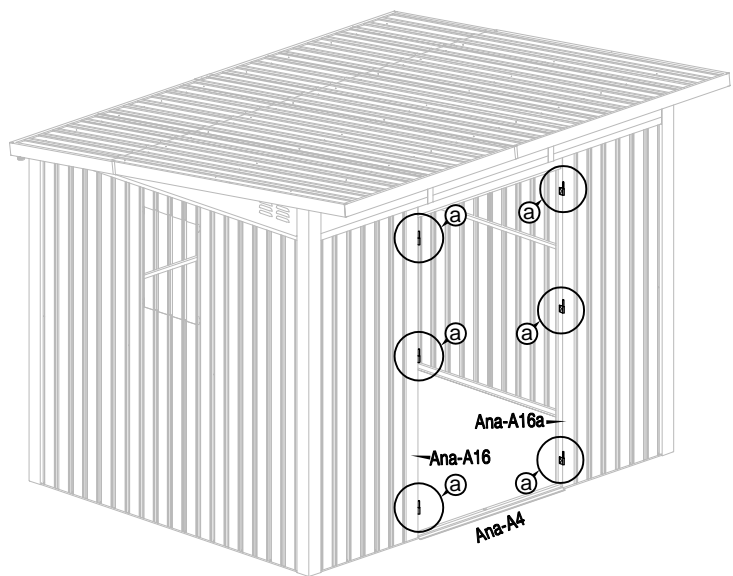
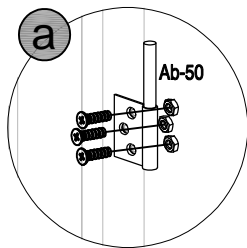
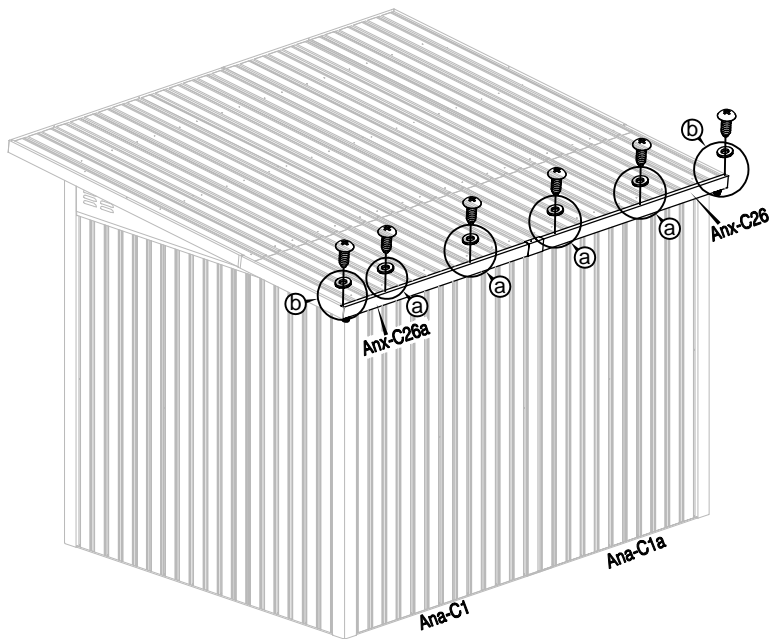
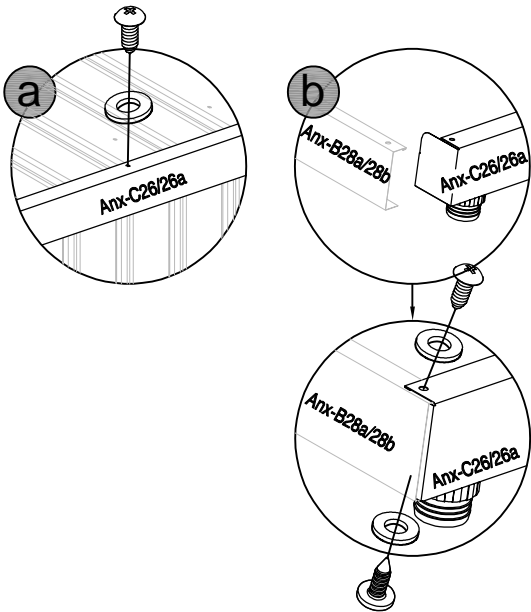
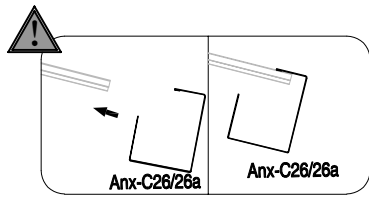
37								
	Anx-A27 x1	Anx-C27a x1	Anx-B28 x2	Anx-B28a x1	Anx-B28b x1	Anx-C41 x10	Anx-C40 x15	Anx-C46 x5





38						
	Anx-C26 x1	Anx-C26a x1	Anx-26 x1	Ana-P1 x2	Anx-C40 x4	Anx-C46 x4



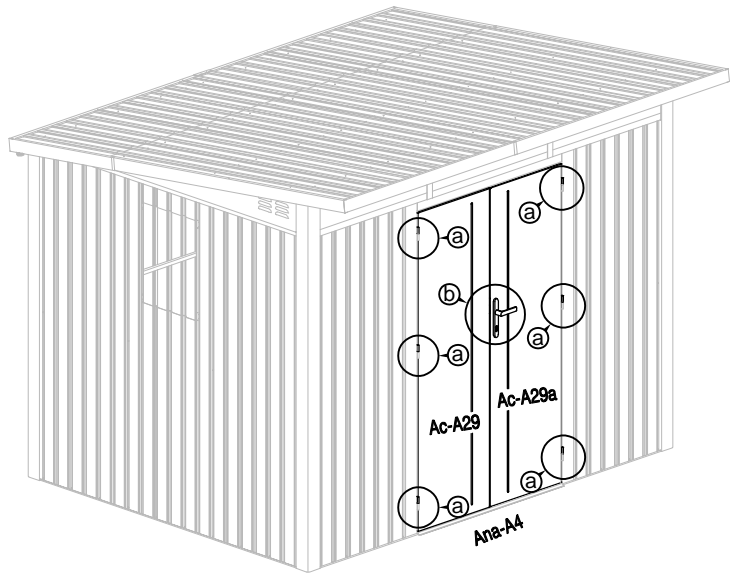
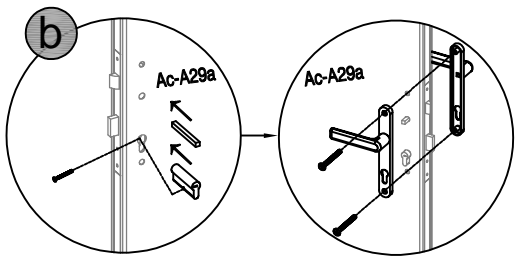
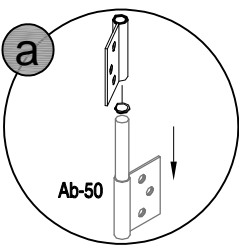

41	 Ac-A29 x1	 Ac-A29a x1	 Ana-54 x1	 Ana-55 x1	 Ana-56 x1	 Ana-57 x1	 Ana-58 x3	
-----------	--	---	--	--	--	--	--	--



42	 Ana-P6 x1	 Anx-C41 x4	
-----------	--	---	--

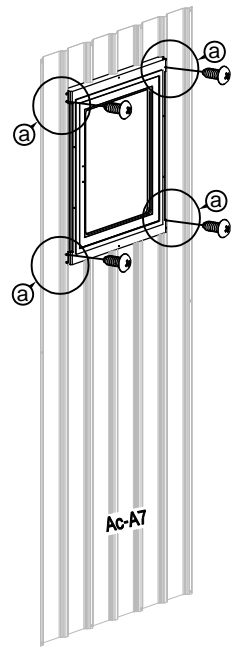
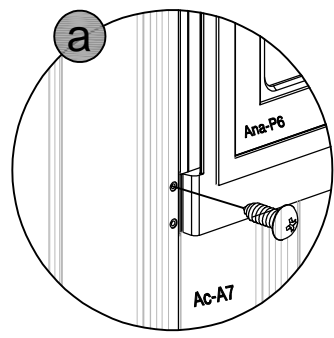
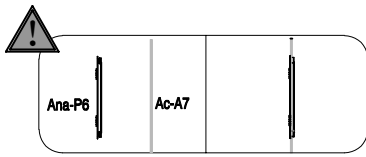

43



Ana-P7 x1



Anx-C41 x10

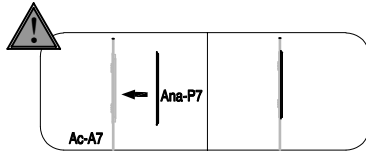

Ac-A7

Ana-P7

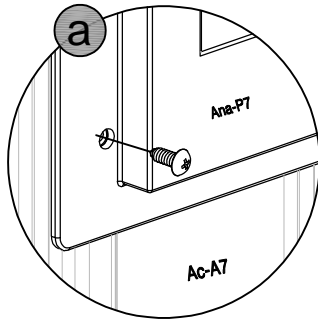

a

Ana-P7

Ac-A7

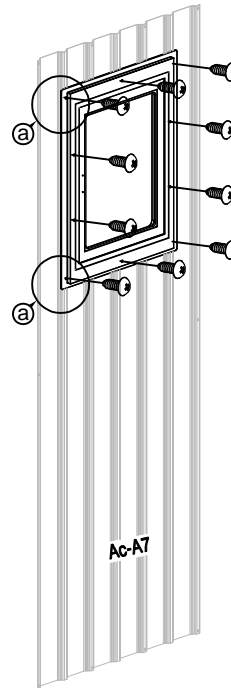

a

Ac-A7

44



Ana-P8 x1



Ana-A42 x2

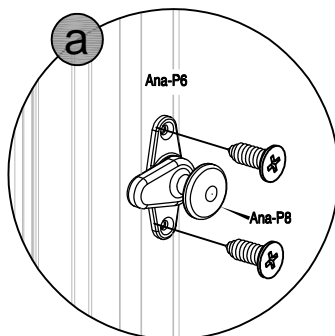

a

Ana-P8

Ana-P8

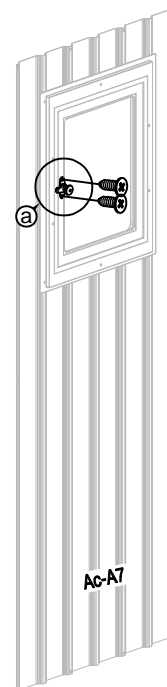

a

Ac-A7



45



Anx-C37 x5.3M

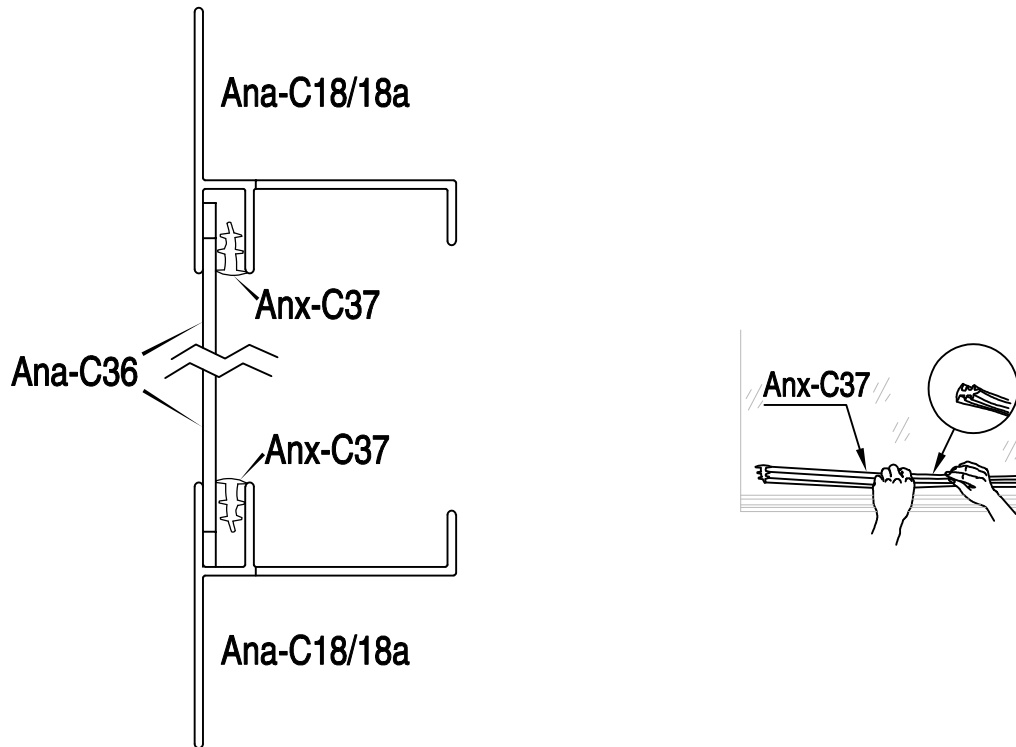

46

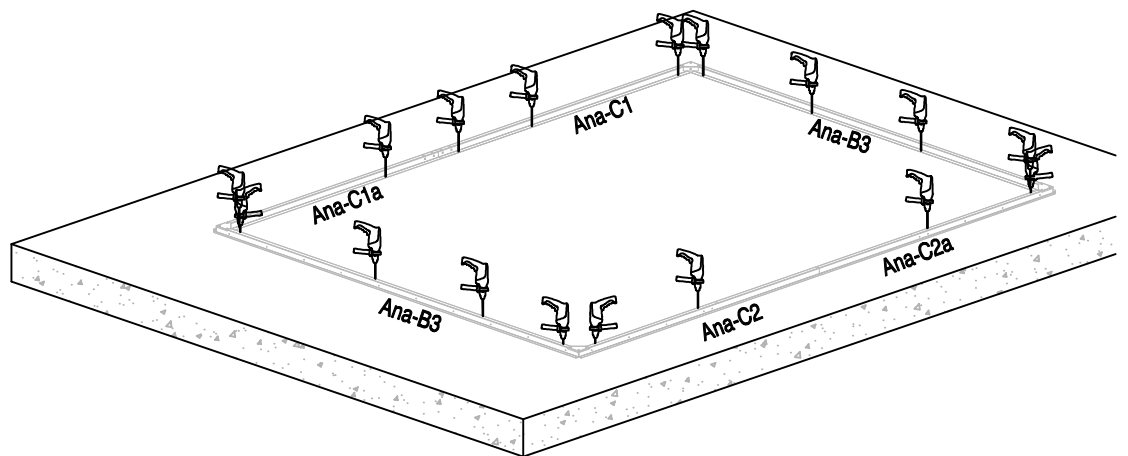
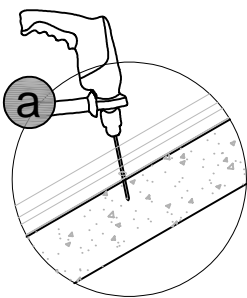
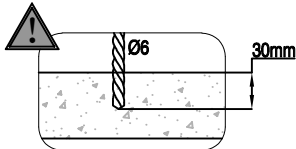
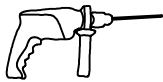

47



Ana-C45 [x17]

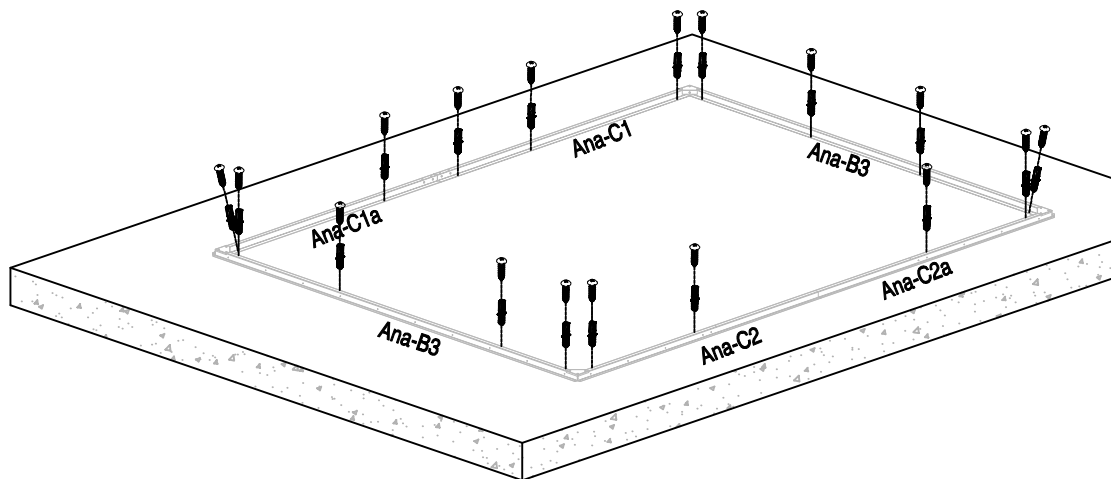
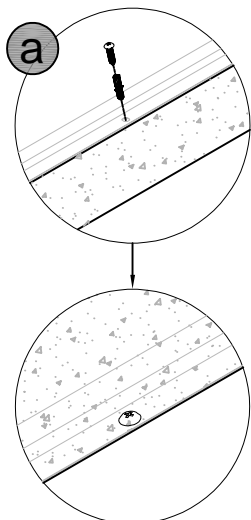

Gardiun

SPACES TO ENJOY

Kovyx Outdoor, S.L

CIFB83904086
Avenida de Andalucía nº 208 A
Salida 24 dirección Madrid
28341 Valdemoro, Madrid

Tel: (+34) 911 34 50 46
E-mail: info@kovyx.com

Servicio Post-Venta
Tel: (+34) 918 09 62 29
E-mail: spv@kovyx.com