

MHI

TECHNICAL MANUAL

**INVERTER WALL MOUNTED TYPE
RESIDENTIAL AIR-CONDITIONERS**
(Split system, air to air heat pump type)

SRK25ZMP-S

SRK35ZMP-S

SRK45ZMP-S

CONTENTS

1. SPECIFICATIONS	3
2. EXTERIOR DIMENSIONS	6
(1) Indoor units	6
(2) Outdoor units	7
(3) Wireless remote control	9
3. ELECTRICAL WIRING	10
(1) Indoor units	10
(2) Outdoor units	11
4. NOISE LEVEL	12
5. PIPING SYSTEM	15
6. RANGE OF USAGE & LIMITATIONS	16
7. CAPACITY TABLES	18
8. APPLICATION DATA	19
9. OUTLINE OF OPERATION CONTROL BY MICROCOMPUTER	27
(1) Operation control function by remote control	27
(2) Unit ON/OFF button	28
(3) Auto restart function	28
(4) Custom cord switching procedure	28
(5) High power operation	29
(6) Economy operation	29
(7) Flap control	29
(8) Timer operation	30
(9) Outline of heating operation	30
(10) Outline of cooling operation	32
(11) Outline of automatic operation	32
(12) Protection control function	33
10. MAINTENANCE DATA	40
(1) Cautions	40
(2) Items to check before troubleshooting	40
(3) Troubleshooting procedure (If the air conditioner does not run at all)	40
(4) Troubleshooting procedure (If the air conditioner runs)	41
(5) Self-diagnosis table	42
(6) Service mode (Trouble mode access function)	43
(7) Inspection procedures corresponding to detail of trouble	51

(8) Phenomenon observed after shortcircuit, wire breakage on sensor 55

(9) Checking the indoor electrical equipment 56

(10) How to make sure of wireless remote control 57

(11) Outdoor unit inspection points 58

11. TECHNICAL INFORMATION 60

■ How to read the model name

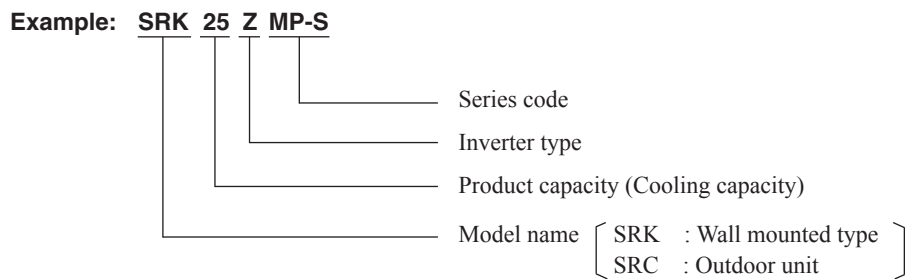

1. SPECIFICATIONS

Model SRK25ZMP-S

Item		Model	SRK25ZMP-S		
			Indoor unit SRK25ZMP-S	Outdoor unit SRC25ZMP-S	
Power source			1 Phase, 220 - 240V, 50Hz		
Operation data	Nominal cooling capacity (range)	kW	2.5 (0.9 (Min.) - 2.8 (Max.))		
	Nominal heating capacity (range)	kW	2.8 (0.8 (Min.) - 3.9 (Max.))		
	Power consumption	Cooling	kW	0.780 (0.25 - 1.01)	
		Heating		0.755 (0.20 - 1.43)	
	Max power consumption			1.65	
	Running current	Cooling	A	3.9 / 3.8 / 3.6 (220 / 230 / 240 V)	
		Heating		3.8 / 3.7 / 3.5 (220 / 230 / 240 V)	
	Inrush current, max current			3.9 / 3.8 / 3.6 (220 / 230 / 240 V) Max. 9	
	Power factor	Cooling	%	90	
		Heating		89	
	EER			3.21	
	COP			3.71	
	Sound power level	Cooling	dB(A)	59	60
		Heating		58	59
Sound pressure level	Cooling	dB(A)	Hi: 45 Me: 34 Lo: 23	47	
	Heating		Hi: 43 Me: 34 Lo: 26	45	
Silent mode sound pressure level			—		
Exterior dimensions (Height x Width x Depth)		mm	262 x 769 x 210	540 x 645(+57) x 275	
Exterior appearance (Munsell color)			Fine snow (8.0Y 9.3/0.1) near equivalent	Stucco white (4.2Y 7.5/1.1) near equivalent	
Net weight		kg	6.9	25	
Compressor type & Q'ty			—	RM-B5077MDE5(Rotary type) x 1	
Compressor motor (Starting method)		kW	—	0.75 (Inverter driven)	
Refrigerant oil (amount, type)		ℓ	—	0.3 (DIAMOND FREEZE MA68)	
Refrigerant (Type, amount, pre-charge length)		kg	R410A 0.655 in outdoor unit (incl. the amount for the piping of 10m)		
Heat exchanger			Louver fins & inner grooved tubing	M fins & inner grooved tubing	
Refrigerant control			Capillary tubes + Electronic expansion valve		
Fan type & Q'ty			Tangential fan x 1	Propeller fan x 1	
Fan motor (stating method)		W	30 x1 (Direct drive)	24 x1 (Direct drive)	
Air flow	Cooling	m ³ /min	Hi: 10.1 Me: 7.3 Lo: 4.2	26.0	
	Heating		Hi: 9.5 Me: 7.3 Lo: 5.2	19.7	
Available external static pressure		Pa	0	0	
Outside air intake			Not possible	—	
Air filter, Quality / Quantity			Polypropylene net (washable)	—	
Shock & vibration absorber			Rubber sleeve (for fan motor)	Rubber sleeve (for fan motor & compressor)	
Electric heater			—	—	
Operation control	Remote control		Wireless-Remote control		
	Room temperature control		Microcomputer thermostat		
	Operation display		RUN: Green, TIMER: Yellow		
Safety equipments			Compressor overheat protection, Overcurrent protection, Frost protection, Serial signal error protection, Indoor fan motor error protection, Heating overload protection (High pressure control), Cooling overload protection		
Installation data	Refrigerant piping size (O.D)	mm	Liquid line : φ 6.35 (1/4") Gas line : φ 9.52 (3/8")		
	Connecting method		Flare connection	Flare connection	
	Attached length of piping	m	Liquid line : 0.39 / Gas line : 0.32	—	
	Insulation for piping		Necessary (Both sides), independent		
	Refrigerant line (one way) length	m	Max. 15		
	Vertical height diff. between O.U. and I.U.	m	Max. 10 (Outdoor unit is higher) / Max. 10 (Outdoor unit is lower)		
Drain hose			Hose connectable (VP 16)	Holes φ 20 x 2 pcs	
Drain pump, max lift height		mm	—	—	
Recommended breaker size		A	16		
L.R.A. (Locked rotor ampere)		A	3.9 / 3.8 / 3.6 (220 / 230 / 240 V)		
Interconnecting wires	Size x Core number		1.5mm ² x 4 cores (Including earth cable) / Terminal block (Screw fixing type)		
IP number			IPX0	IPX4	
Standard accessories			Mounting kit		
Option parts			—		

Note (1) The data are measured at the following conditions. The pipe length is 7.5m.

operation	item	Indoor air temperature		Outdoor air temperature		Standards
		DB	WB	DB	WB	
Cooling		27°C	19°C	35°C	24°C	ISO5151-T1
		20°C	—	7°C	6°C	

- (2) This air-conditioner is manufactured and tested in conformity with the ISO.
- (3) Sound level indicates the value in an anechoic chamber. During operation these value are somewhat higher due to ambient conditions.
- (4) Select the breaker size according to the own national standard.
- (5) The refrigerant quantity to be charged includes the refrigerant in 10 m connecting piping. (purging is not required even for the short piping.)
If the piping length is longer, when it is 10 to 15 m, add 20 g refrigerant per meter.

Model SRK35ZMP-S

Item		Model		SRK35ZMP-S		
				Indoor unit SRK35ZMP-S	Outdoor unit SRC35ZMP-S	
Power source				1 Phase, 220 - 240V, 50Hz		
Operation data	Nominal cooling capacity (range)	kW		3.2 (0.9 (Min.) - 3.5 (Max.))		
	Nominal heating capacity (range)	kW		3.6 (0.9 (Min.) - 4.3 (Max.))		
	Power consumption	Cooling	kW		0.995 (0.23 - 1.32)	
		Heating	kW		0.995 (0.19 - 1.31)	
	Max power consumption				1.65	
	Running current	Cooling	A		4.9 / 4.7 / 4.5 (220 / 230 / 240 V)	
		Heating	A		4.9 / 4.7 / 4.5 (220 / 230 / 240 V)	
	Inrush current, max current				4.9 / 4.7 / 4.5 (220 / 230 / 240 V) Max. 9	
	Power factor	Cooling	%		93	
		Heating	%		93	
	EER	Cooling			3.22	
	COP	Heating			3.62	
	Sound power level	Cooling	dB(A)		60	60
		Heating	dB(A)		58	60
Sound pressure level	Cooling	dB(A)		Hi: 47 Me: 36 Lo: 23	49	
	Heating	dB(A)		Hi: 44 Me: 36 Lo: 28	48	
Silent mode sound pressure level				-		
Exterior dimensions (Height x Width x Depth)		mm		262 x 769 x 210		
Exterior appearance (Munsell color)				Fine snow (8.0Y 9.3/0.1) near equivalent		
Net weight		kg		7.2		
Compressor type & Q'ty				-		
Compressor motor (Starting method)		kW		-		
Refrigerant oil (amount, type)		ℓ		-		
Refrigerant (Type, amount, pre-charge length)		kg		R410A 0.81 in outdoor unit (incl. the amount for the piping of 15m)		
Heat exchanger				Louver fins & inner grooved tubing		
Refrigerant control				M fins & inner grooved tubing		
Fan type & Q'ty				Capillary tubes + Electronic expansion valve		
Fan motor (stating method)		W		Tangential fan x 1		
Air flow		m ³ /min		30 x1 (Direct drive)		
Available external static pressure		Pa		Hi: 9.5 Me: 6.8 Lo: 4.2		
Outside air intake				-		
Air filter, Quality / Quantity				25.4		
Shock & vibration absorber				Hi: 9.6 Me: 7.4 Lo: 5.5		
Electric heater				20.5		
Operation control				0		
Safety equipments				Not possible		
Installation data				Polypropylene net (washable)		
Drain pump, max lift height		mm		Rubber sleeve (for fan motor)		
Recommended breaker size		A		-		
L.R.A. (Locked rotor ampere)		A		-		
Interconnecting wires		Size x Core number		-		
IP number				Capillary tubes + Electronic expansion valve		
Standard accessories				Propeller fan x 1		
Option parts				24 x1 (Direct drive)		

Note (1) The data are measured at the following conditions. The pipe length is 7.5m.

operation	item	Indoor air temperature		Outdoor air temperature		Standards
		DB	WB	DB	WB	
Cooling		27°C	19°C	35°C	24°C	ISO5151-T1
		20°C	-	7°C	6°C	

- (2) This air-conditioner is manufactured and tested in conformity with the ISO.
- (3) Sound level indicates the value in an anechoic chamber. During operation these value are somewhat higher due to ambient conditions.
- (4) Select the breaker size according to the own national standard.
- (5) The refrigerant quantity to be charged includes the refrigerant in 15 m connecting piping. (purging is not required even for the short piping.)

Model SRK45ZMP-S

Item		Model	SRK45ZMP-S		
			Indoor unit SRK45ZMP-S	Outdoor unit SRC45ZMP-S	
Power source			1 Phase, 220 - 240V, 50Hz		
Operation data	Nominal cooling capacity (range)	kW	4.5 (0.9 (Min.) - 4.8 (Max.))		
	Nominal heating capacity (range)	kW	5.0 (0.8 (Min.) - 5.8 (Max.))		
	Power consumption	Cooling	kW	1.495 (0.22-1.98)	
		Heating		1.385 (0.20-1.86)	
	Max power consumption			2.68	
	Running current	Cooling	A	7.0 / 6.7 / 6.4 (220 / 230 / 240 V)	
		Heating		6.5 / 6.2 / 6.0 (220 / 230 / 240 V)	
	Inrush current, max current			7.0 / 6.7 / 6.4 (220 / 230 / 240 V) Max.14	
	Power factor	Cooling	%	97	
		Heating		97	
	EER	Cooling		3.01	
	COP	Heating		3.61	
	Sound power level	Cooling	dB(A)	60	
		Heating		65	
Sound pressure level	Cooling	dB(A)	Hi : 46 Me : 40 Lo : 25		
	Heating		Hi : 48 Me : 43 Lo : 32		
Silent mode sound pressure level			-		
Exterior dimensions (Height x Width x Depth)		mm	262 x 769 x 210		
Exterior appearance (Munsell color)			Fine snow (8.0Y 9.3/0.1) near equivalent		
Net weight		kg	7.6		
Compressor type & Q'ty			-		
Compressor motor (Starting method)		kW	1.10 (Inverter driven)		
Refrigerant oil (amount, type)		ℓ	0.45 (FVC68D)		
Refrigerant (Type, amount, pre-charge length)		kg	R410A 1.20 in outdoor unit (incl. the amount for the piping of 15m)		
Heat exchanger			Louver fins & inner grooved tubing		
Refrigerant control			Capillary tubes + Electronic expansion valve		
Fan type & Q'ty			Tangential fan x 1		
Fan motor (stating method)		W	30 x1 (Direct drive)		
Air flow	Cooling	m³/min	Hi : 9.0 Me : 7.2 Lo : 3.8		
	Heating		Hi : 12.0 Me : 9.2 Lo : 6.2		
Available external static pressure		Pa	0		
Outside air intake			Not possible		
Air filter, Quality / Quantity			Polypropylene net (washable)		
Shock & vibration absorber			Rubber sleeve (for fan motor)		
Electric heater			-		
Operation control	Remote control		Wireless-Remote control		
	Room temperature control		Microcomputer thermostat		
	Operation display		RUN: Green, TIMER: Yellow		
Safety equipments			Compressor overheat protection, Overcurrent protection, Frost protection, Serial signal error protection, Indoor fan motor error protection, Heating overload protection (High pressure control), Cooling overload protection		
Installation data	Refrigerant piping size (O.D)	mm	Liquid line : φ 6.35 (1/4") Gas line : φ 12.7 (1/2")		
	Connecting method		Flare connection		
	Attached length of piping	m	Liquid line : 0.39 / Gas line : 0.32		
	Insulation for piping		Necessary (Both sides), independent		
	Refrigerant line (one way) length	m	Max. 25		
	Vertical height diff. between O.U. and I.U.	m	Max. 15 (Outdoor unit is higher) / Max. 15 (Outdoor unit is lower)		
Drain hose			Hose connectable (VP 16)		
Drain pump, max lift height		mm	-		
Recommended breaker size		A	16		
L.R.A. (Locked rotor ampere)		A	7.0 / 6.7 / 6.4 (220 / 230 / 240 V)		
Interconnecting wires		Size x Core number	1.5mm² x 4 cores (Including earth cable) / Terminal block (Screw fixing type)		
IP number			IPX0		
Standard accessories			Mounting kit		
Option parts			-		

Note (1) The data are measured at the following conditions.

The pipe length is 7.5m.

operation	item	Indoor air temperature		Outdoor air temperature		Standards
		DB	WB	DB	WB	
Cooling		27°C	19°C	35°C	24°C	ISO5151-T1
Heating		20°C	-	7°C	6°C	

- (2) This air-conditioner is manufactured and tested in conformity with the ISO.
- (3) Sound level indicates the value in an anechoic chamber. During operation these value are somewhat higher due to ambient conditions.
- (4) Select the breaker size according to the own national standard.
- (5) The refrigerant quantity to be charged includes the refrigerant in 15 m connecting piping. (purging is not required even for the short piping.)
If the piping length is longer, when it is 15 to 25 m, add 20 g refrigerant per meter.

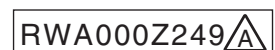

2. EXTERIOR DIMENSIONS

(1) Indoor units

Models SRK25ZMP-S, 35ZMP-S, 45ZMP-S

Symbol	Content	
A	Gas piping	Model 25,35 ϕ 9.52 (3/8") (Flare)
		Model 45 ϕ 12.7 (1/2") (Flare)
B	Liquid piping	ϕ 6.35 (1/4") (Flare)
C	Hole on wall for right rear piping	(ϕ 65)
D	Hole on wall for left rear piping	(ϕ 65)
E	Drain hose	VP16
F	Outlet for wiring	
G	Outlet for piping (on both side)	

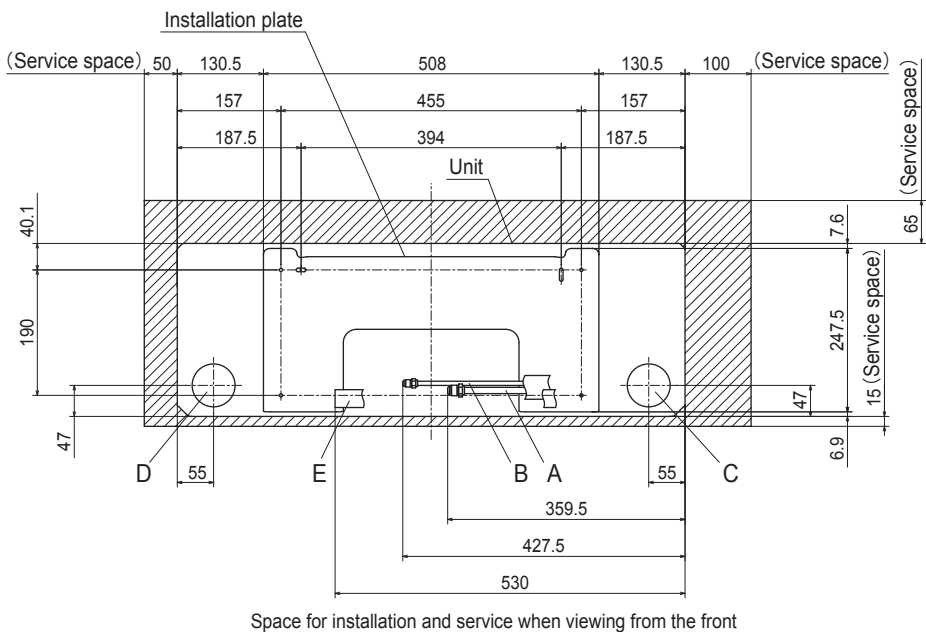
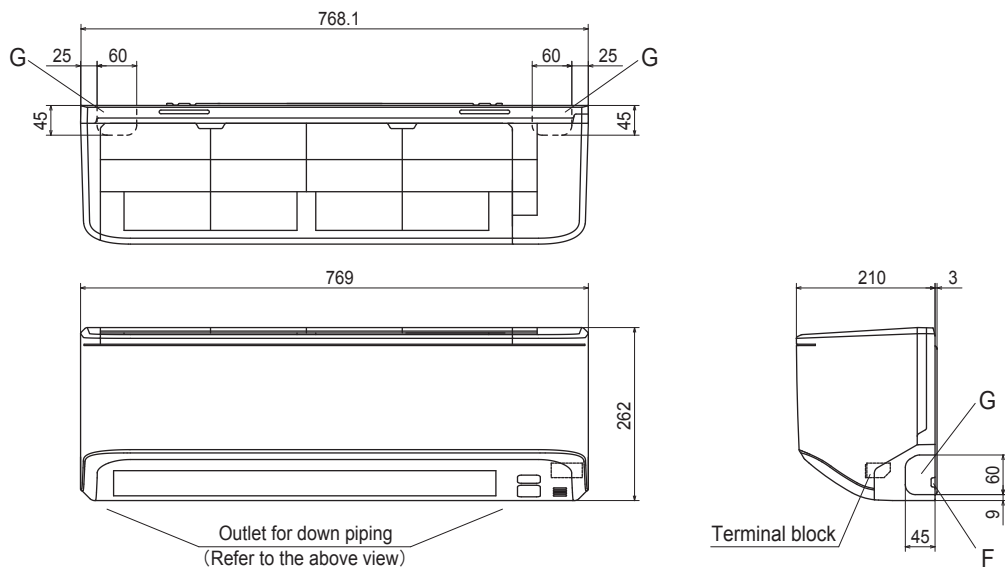

Wireless remote control

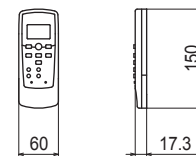

Note (1) The model name label is attached on the underside of the indoor unit.

Unit:mm

RLC000Z003

(2) Outdoor units
Models SRC25ZMP-S, 35ZMP-S

Symbol	Content	
A	Service valve connection (gas side)	φ 9.52 (3/8") (Flare)
B	Service valve connection (liquid side)	φ 6.35 (1/4") (Flare)
C	Pipe/cable draw-out hole	
D	Drain discharge hole	φ 20 × 2places
E	Anchor bolt hole	M10 × 4places

Notes

- (1) It must not be surrounded by walls on the four sides.
- (2) The unit must be fixed with anchor bolts. An anchor bolt must not protrude more than 15mm.
- (3) Where the unit is subject to strong winds, lay it in such a direction that the blower outlet faces perpendicularly to the dominant wind direction.
- (4) Leave 1m or more space above the unit.
- (5) A wall in front of the blower outlet must not exceed the units height.
- (6) The model name label is attached on the right side of the unit.

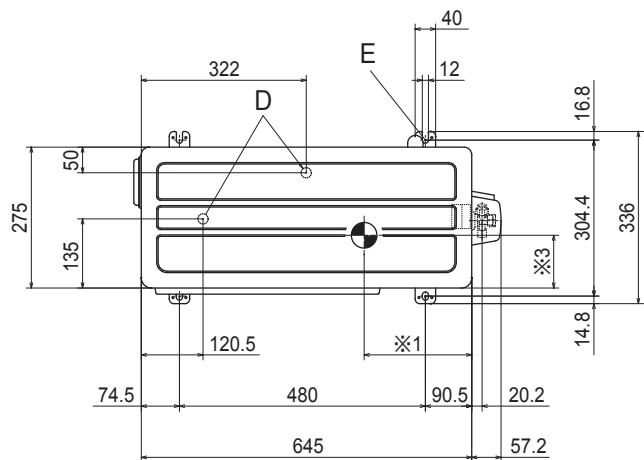

Dimensions	※1	※2	※3
MODEL			
SRC25ZMP-S	210	240	103
SRC35ZMP-S	220	240	108

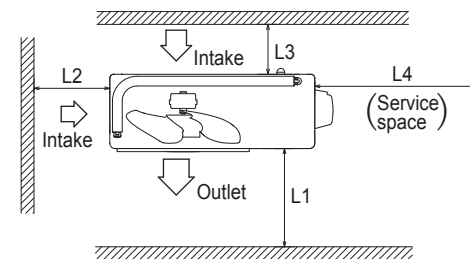

Minimum installation space

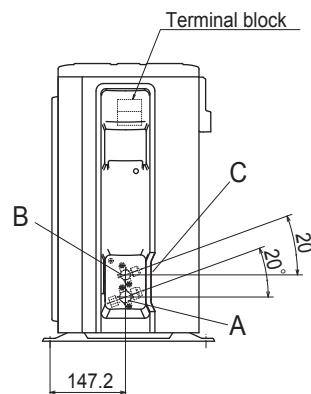
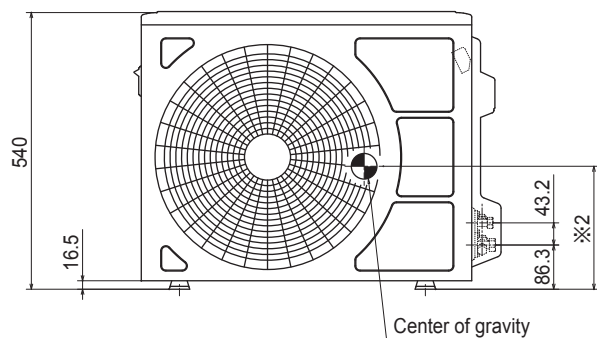

Dimensions	Examples of installation			
	I	II	III	IV
L1	Open	280	280	180
L2	100	100	Open	Open
L3	100	80	80	80
L4	250	Open	250	Open

Unit:mm

RCW0000Z002

RCV000Z016

Symbol	Content	
A	Service valve connection (gas side)	φ 12.7 (1/2") (Flare)
B	Service valve connection (liquid side)	φ 6.35 (1/4") (Flare)
C	Pipe/cable draw-out hole	
D	Drain discharge hole	φ 20 × 2places
E	Anchor bolt hole	M10 × 4places

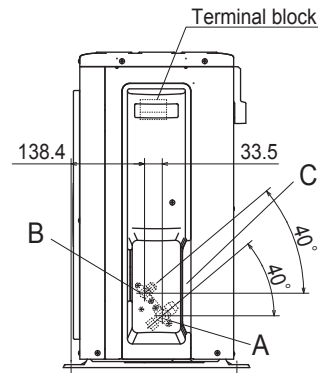
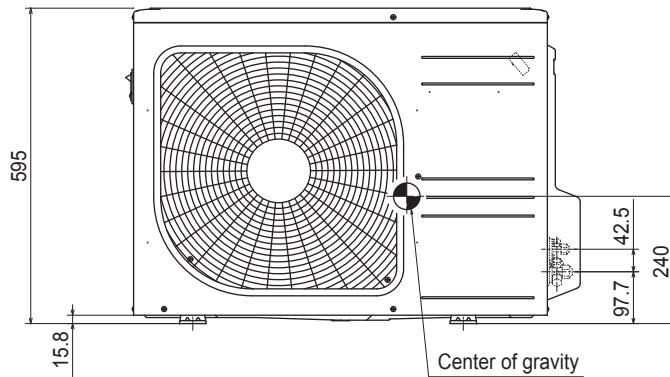
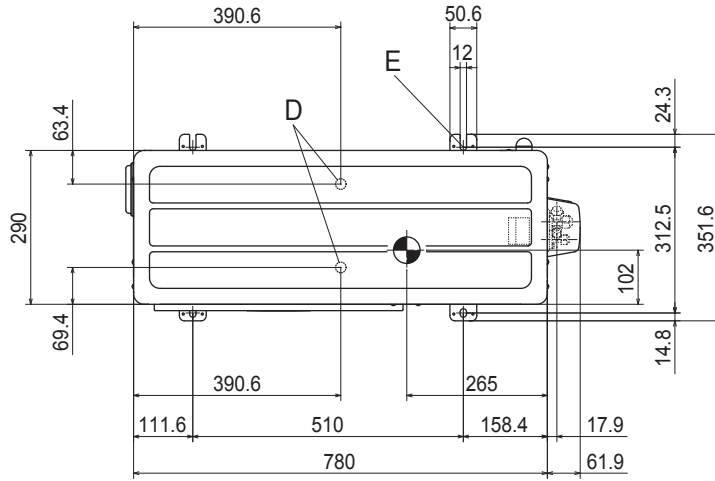

Notes

- (1) It must not be surrounded by walls on the four sides.
- (2) The unit must be fixed with anchor bolts. An anchor bolt must not protrude more than 15mm.
- (3) Where the unit is subject to strong winds, lay it in such a direction that the blower outlet faces perpendicularly to the dominant wind direction.
- (4) Leave 1m or more space above the unit.
- (5) A wall in front of the blower outlet must not exceed the units height.
- (6) The model name label is attached on the lower right corner of the front panel.

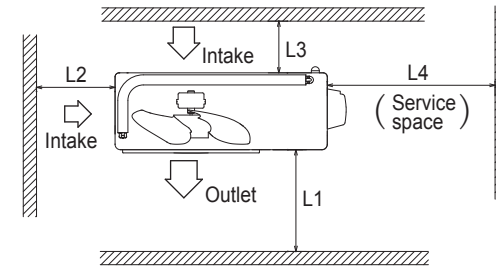

Minimum installation space

Dimensions	Examples of installation			
	I	II	III	IV
L1	Open	280	280	180
L2	100	100	Open	Open
L3	100	80	80	80
L4	250	Open	250	Open

Unit:mm

Model SRC45ZMP-S

(3) Wireless remote control

Unit: mm

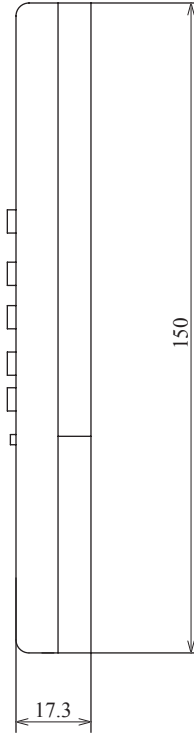
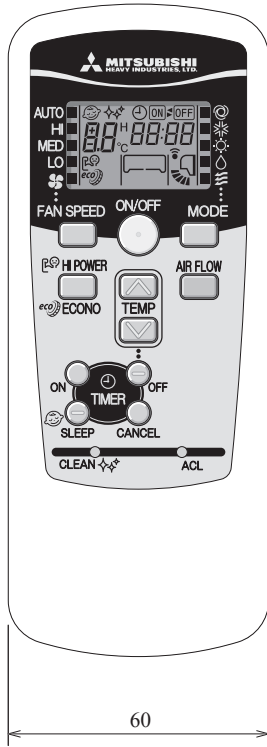

3. ELECTRICAL WIRING

(1) Indoor units

Models SRK25ZMP-S, 35ZMP-S, 45ZMP-S

Item	Description
CNE	Connector
CNF	
CNG	
CNM	
CNU	
FM	Fan motor
SM	Flap motor
HD	Humidity sensor
Th1	Room temp. sensor
Th2	Heat exch. sensor
DS	Diode stack
F	Fuse
TB	Terminal block
Va	Varistor

Mark	Color
BK	Black
BL	Blue
RD	Red
WH	White
Y	Yellow
Y/G	Yellow/Green

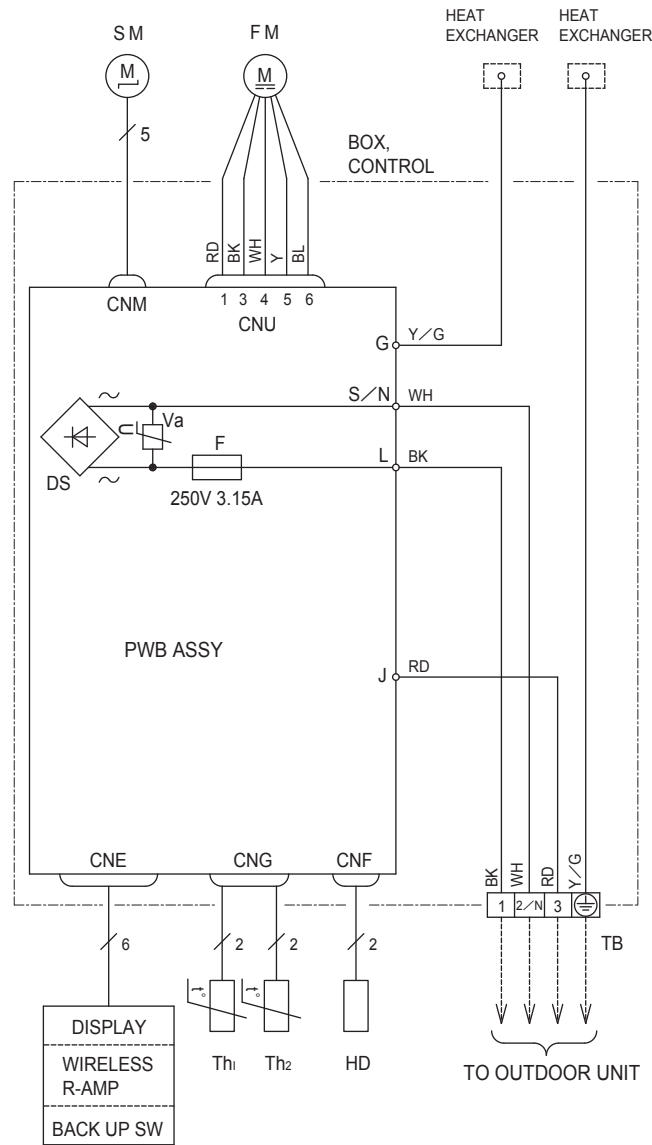

RWA000Z250

(2) Outdoor units

Models SRC25ZMP-S, 35ZMP-S, 45ZMP-S

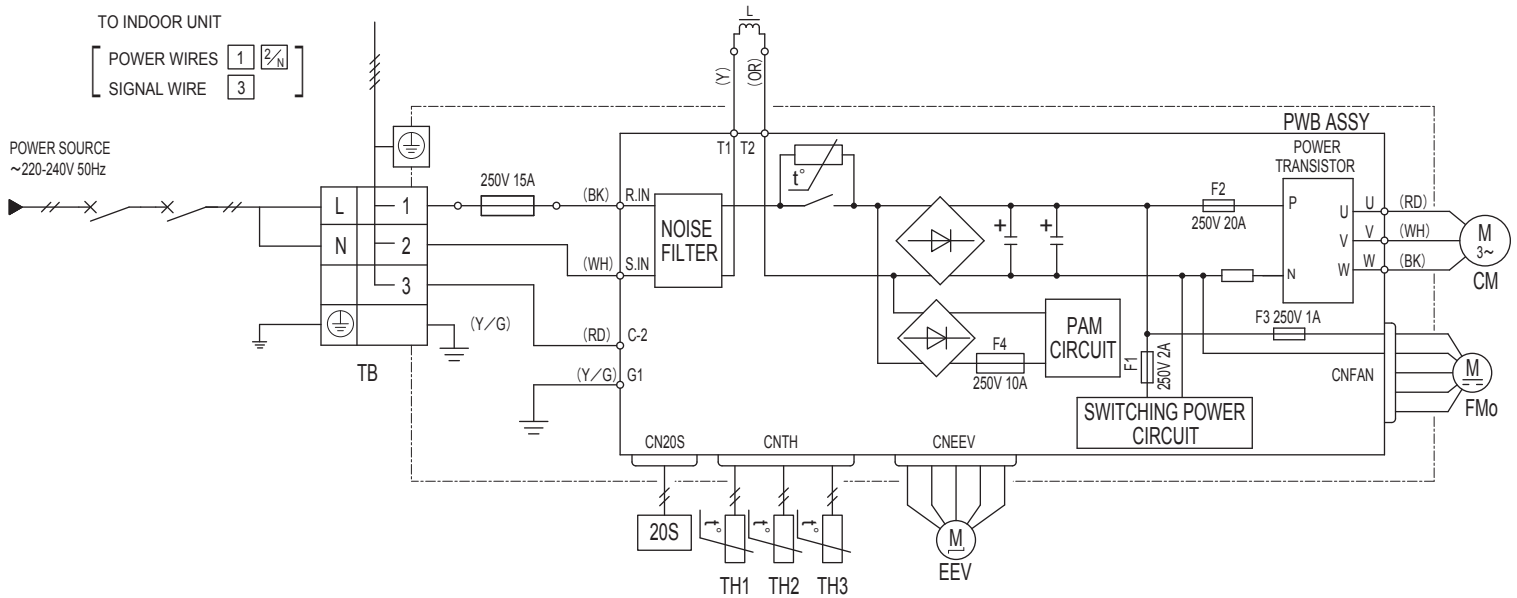

Power cable, indoor-outdoor connecting wires

Model	MAX running current (A)	Power cable size (mm ²)	Power cable length (m)	indoor-outdoor wire size x number	Earth wire size (mm ²)
25	9	2.0	32	1.5mm ² x 4	1.5
35					
45	14	2.0	18	1.5mm ² x 4	1.5

- The specifications shown in the above table are for units without heaters. For units with heaters, refer to the installation instructions or the construction instructions of the indoor unit.
- Switchgear of Circuit breaker capacity which is calculated from MAX. over current should be chosen along the regulations in each country.
- The cable specifications are based on the assumption that a metal or plastic conduit is used with no more than three cables contained in a conduit and a voltage drop is 2%. For an installation falling outside of these conditions, please follow the internal cabling regulations. Adapt it to the regulation in effect in each country.

Item	Description
CM	Compressor motor
CN20S	Connector
CNEEV	
CNFAN	
CNTH	
EEV	Electric expansion valve (coil)
FMo	Fan motor
L	Reactor
TB	Terminal block
TH1	Heat exchanger sensor (outdoor unit)
TH2	Outdoor air temp. sensor
TH3	Discharge pipe temp. sensor
20S	Solenoid coil for 4 way valve

Mark	Color
BK	Black
OR	Orange
RD	Red
WH	White
Y	Yellow
Y/G	Yellow/Green

RWC000Z261

4. NOISE LEVEL

Model SRK25ZMP-S

Condition ISO-T1, JIS C 9612

(Indoor Unit)

Model	SRK25ZMP-S	
Noise Level	Cooling	45 dB(A)
	Heating	43 dB(A)

● Mike position

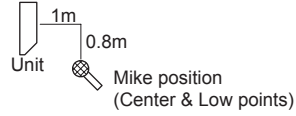

× Cooling ○ — Heating

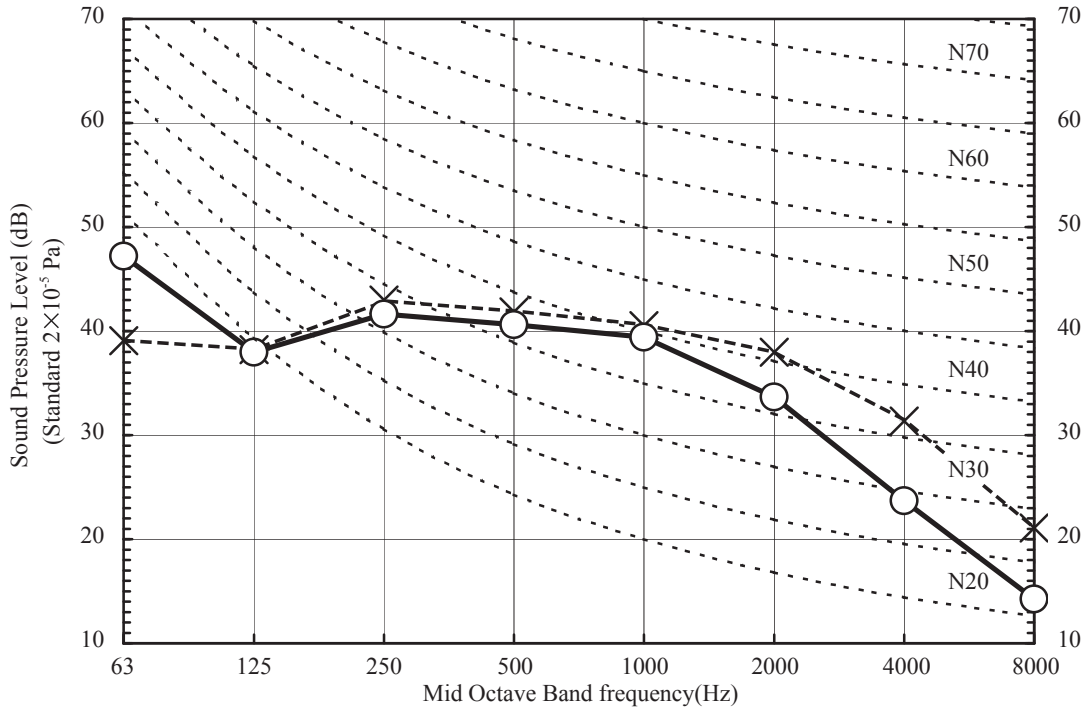

(Outdoor Unit)

Model	SRC25ZMP-S	
Noise Level	Cooling	47 dB(A)
	Heating	45 dB(A)

● Mike position: at highest noise level in position as mentioned below
Distance from front side 1m

× Cooling ○ — Heating

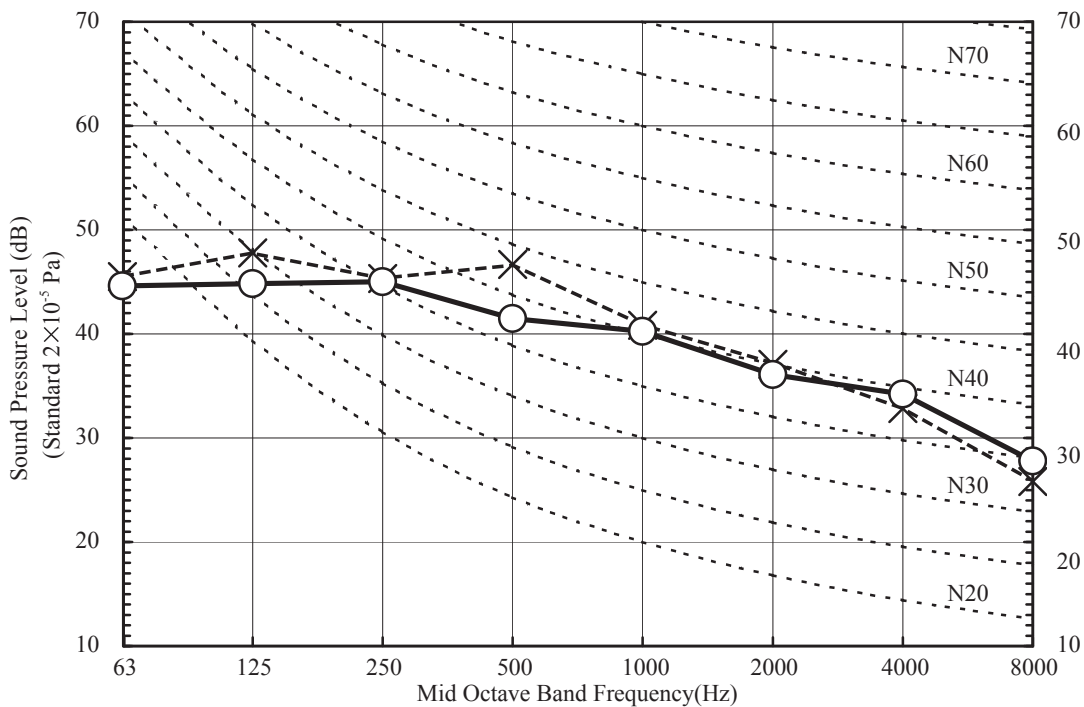

Model SRK35ZMP-S

Condition ISO-T1,JIS C 9612

(Indoor Unit)

Model	SRK35ZMP-S	
Noise Level	Cooling	47 dB(A)
	Heating	44 dB(A)

●Mike position



x Cooling ○ — Heating

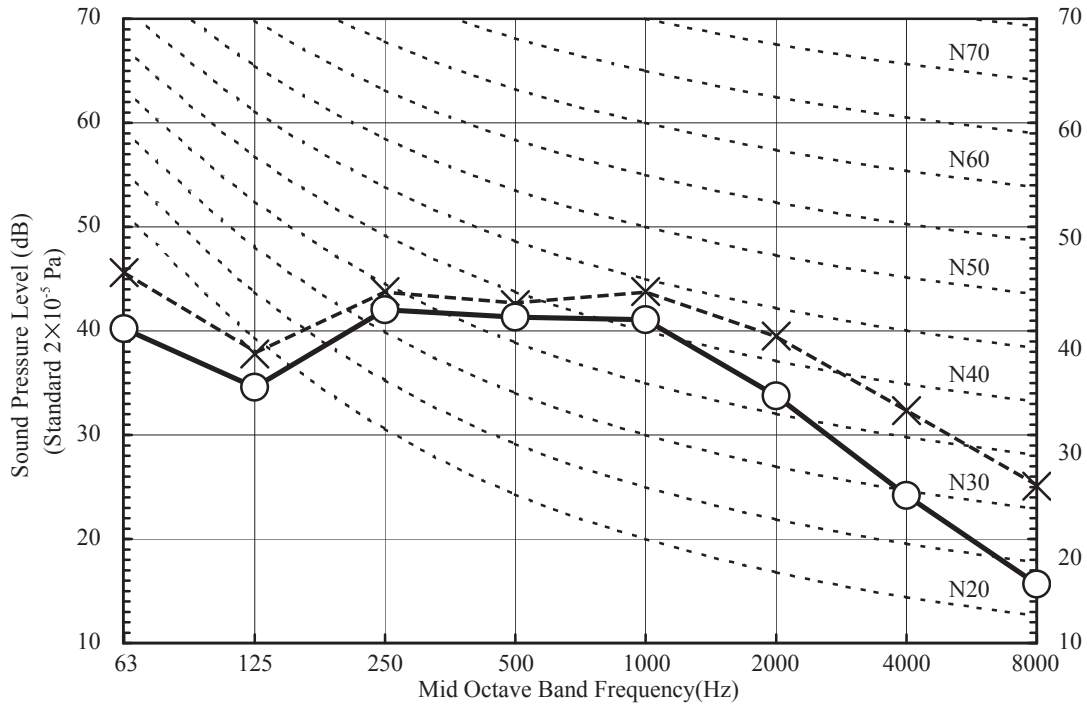

(Outdoor Unit)

Model	SRC35ZMP-S	
Noise Level	Cooling	49 dB(A)
	Heating	48 dB(A)

●Mike position: at highest noise level in position as mentioned below
Distance from front side 1m

x Cooling ○ — Heating

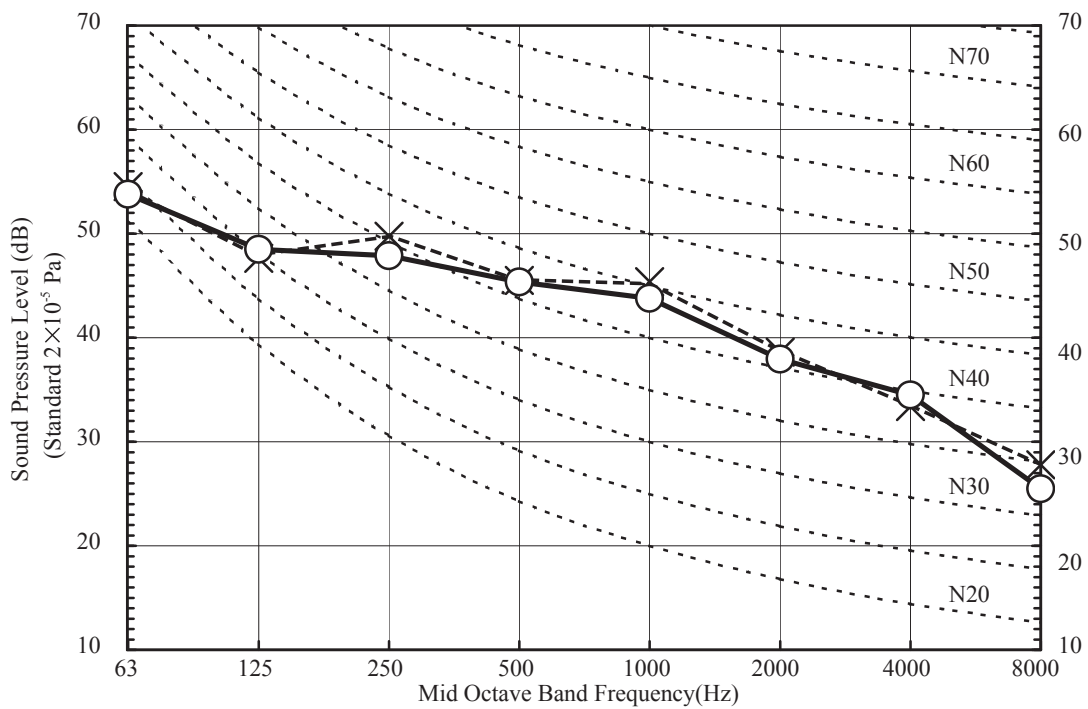

Model SRK45ZMP-S

Condition ISO-T1,JIS C 9612

(Indoor Unit)

Model	SRK45ZMP-S	
Noise	Cooling	46 dB(A)
Level	Heating	48 dB(A)

● Mike position



x Cooling ○ — Heating

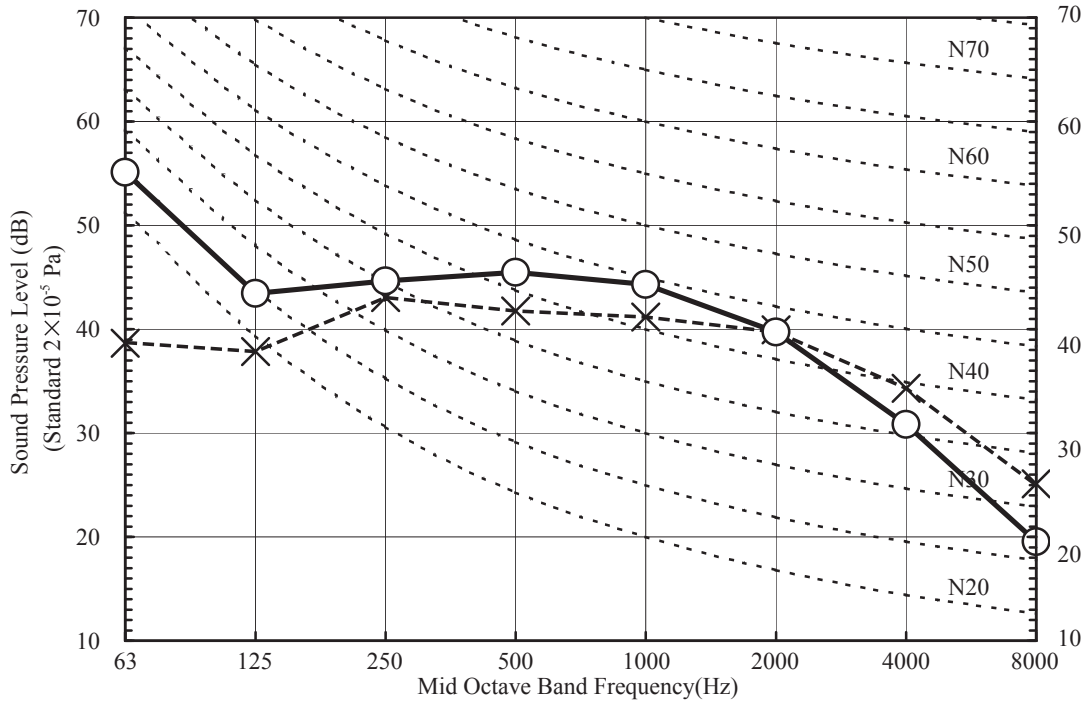

(Outdoor Unit)

Model	SRC45ZMP-S	
Noise	Cooling	52 dB(A)
Level	Heating	53 dB(A)

● Mike position: at highest noise level in position as mentioned below
Distance from front side 1m

x Cooling ○ — Heating

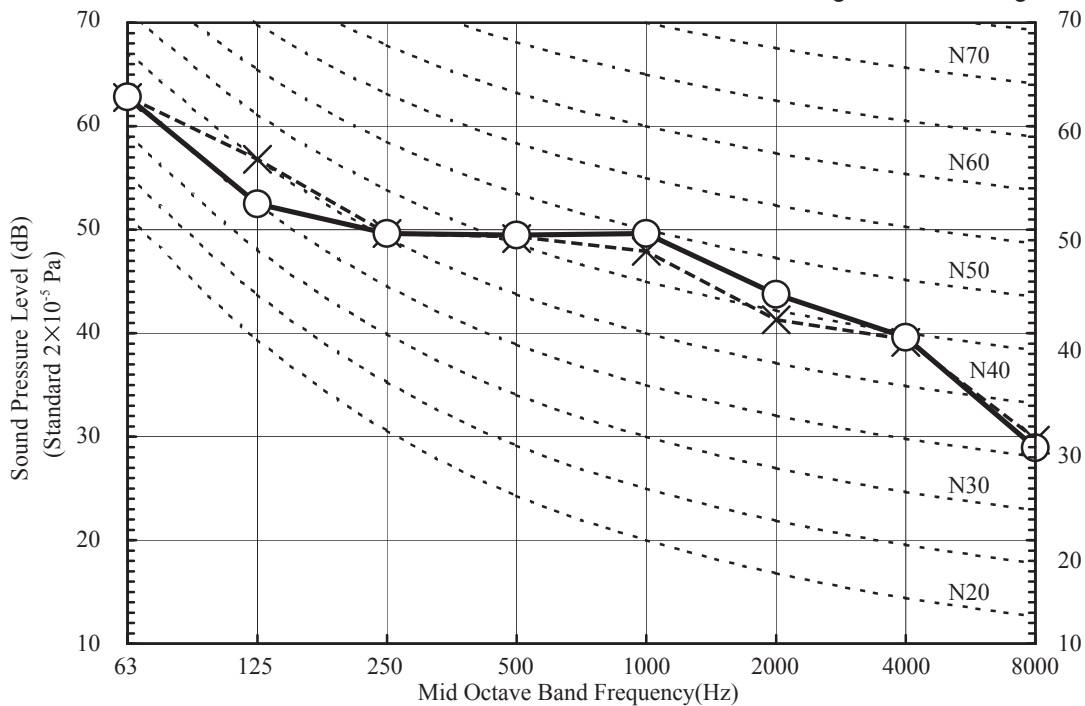

5. PIPING SYSTEM

Models SRK25ZMP-S, 35ZMP-S

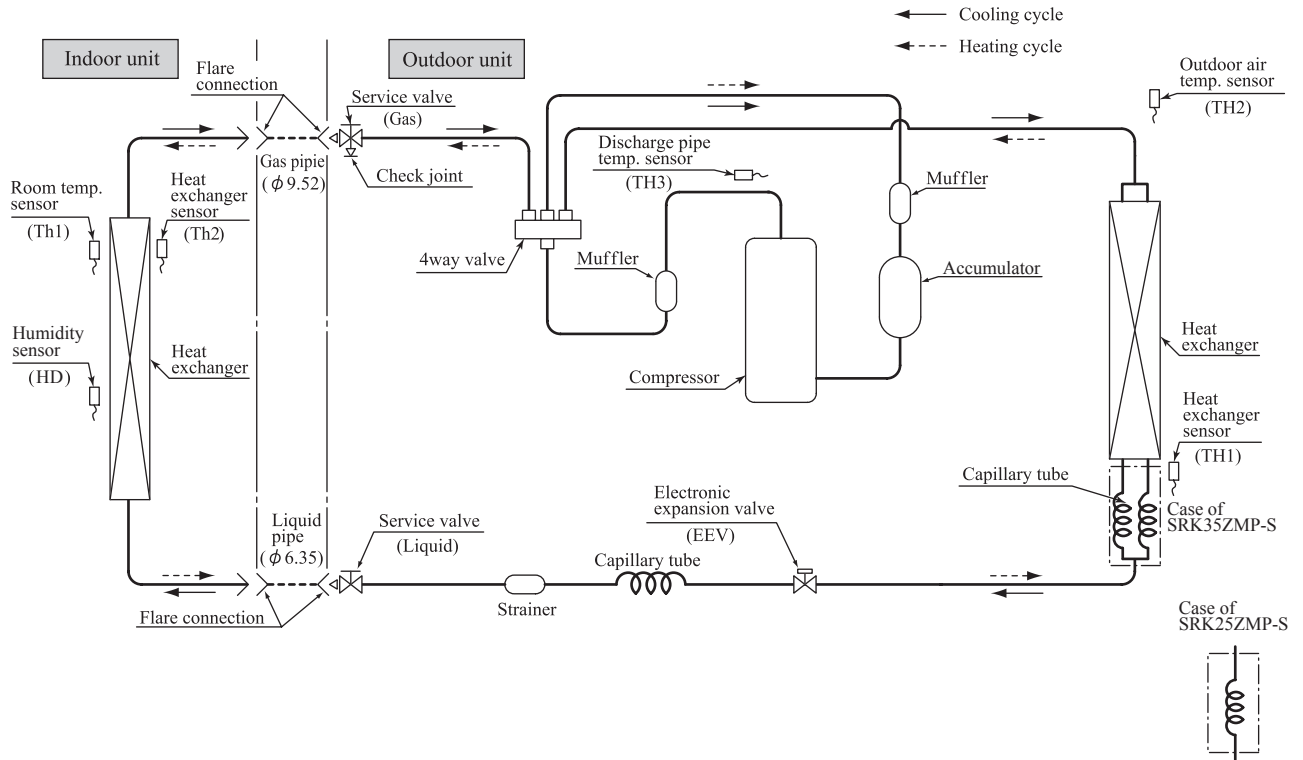

Model SRK45ZMP-S

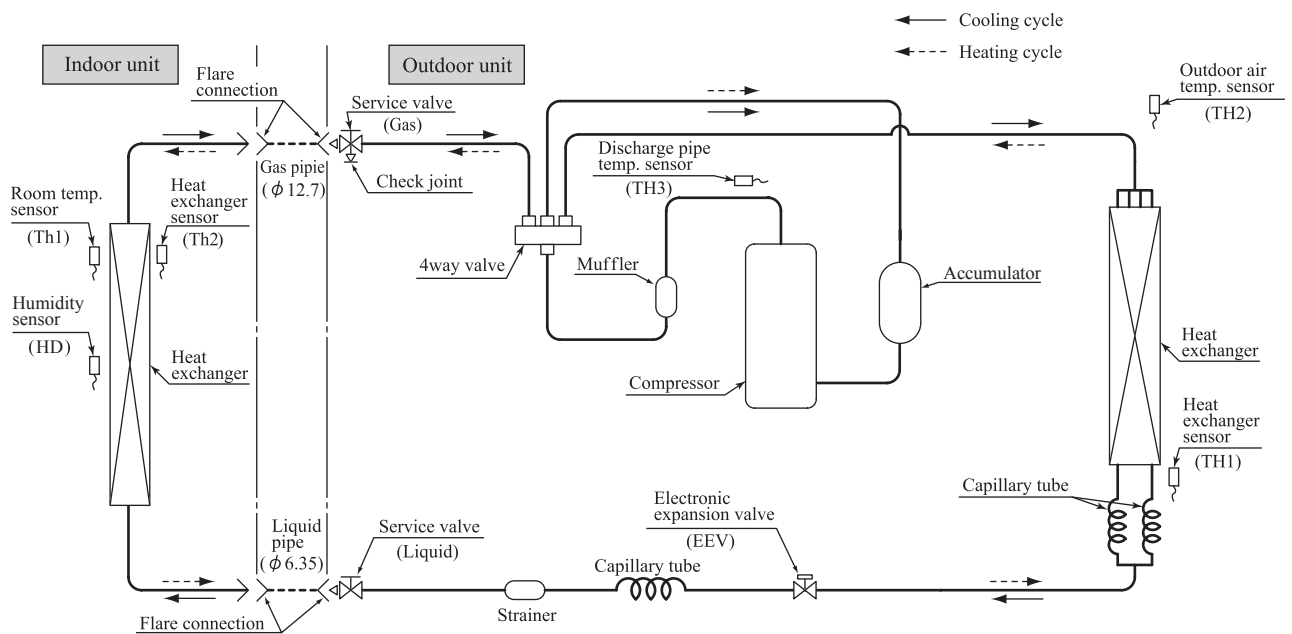

6. RANGE OF USAGE & LIMITATIONS

Item	Models	
	SRK25ZMP-S, 35ZMP-S	SRK45ZMP-S
Indoor return air temperature (Upper, lower limits)	Cooling operation : Approximately 18 to 32°C D.B. Heating operation : Approximately 15 to 30°C D.B. (Refer to the selection chart)	
Outdoor air temperature (Upper, lower limits)	Cooling operation : Approximately -15 to 46°C D.B. Heating operation : Approximately -15 to 24°C D.B. (Refer to the selection chart)	
Refrigerant line (one way) length	Max. 15m	Max. 25m
Vertical height difference between outdoor unit and indoor unit	Max. 10m (Outdoor unit is higher) Max. 10m (Outdoor unit is lower)	Max. 15m (Outdoor unit is higher) Max. 15m (Outdoor unit is lower)
Power source voltage	Rating ±10%	
Voltage at starting	Min. 85% of rating	
Frequency of ON-OFF cycle	Max. 4 times/h (Inching prevention 10 minutes)	Max. 7 times/h (Inching prevention 5 minutes)
ON and OFF interval	Min. 3 minutes	

Selection chart

Correct the cooling and heating capacity in accordance with the conditions as follows. The net cooling and heating capacity can be obtained in the following way.

Net capacity = Capacity shown on specification × Correction factors as follows.

(1) Coefficient of cooling and heating capacity in relation to temperatures

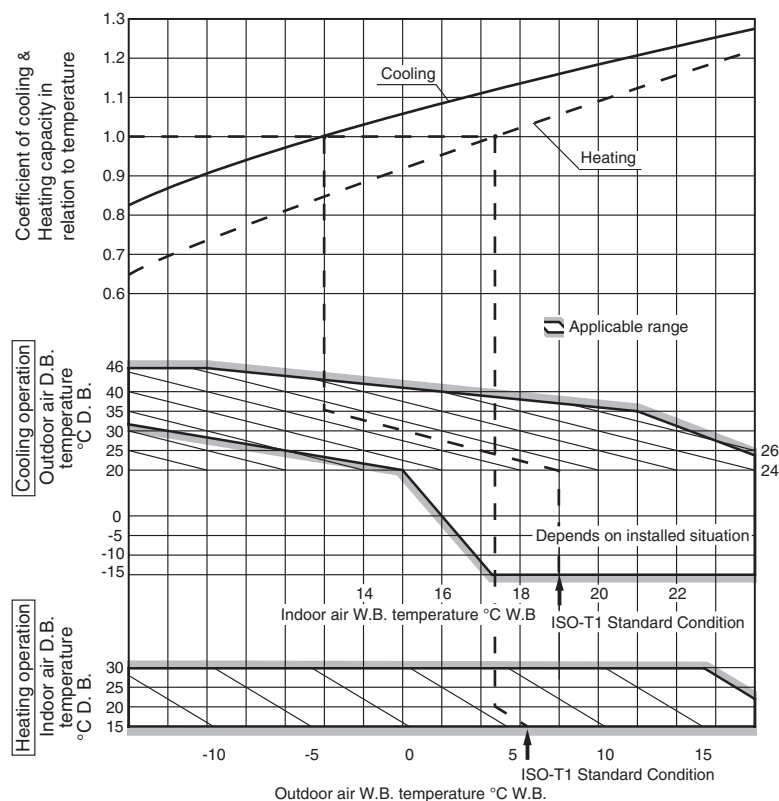

(2) Correction of cooling and heating capacity in relation to one way length of refrigerant piping

It is necessary to correct the cooling and heating capacity in relation to the one way piping length between the indoor and outdoor units.

Piping length [m]	7	10	15	20	25	30
Cooling	1.0	0.99	0.975	0.965	0.95	0.935
Heating	1.0	1.0	1.0	1.0	1.0	1.0

(3) Correction relative to frosting on outdoor heat exchanger during heating

In additions to the foregoing corrections (1), (2) the heating capacity needs to be adjusted also with respect to the frosting on the outdoor heat exchanger.

Air inlet temperature of outdoor unit in °CWB	-15	-10	-9	-7	-5	-3	-1	1	3	5 or more
Adjustment coefficient	0.95	0.95	0.94	0.93	0.91	0.88	0.86	0.87	0.92	1.00

How to obtain the cooling and heating capacity

Example : The net cooling capacity of the model SRK35ZMP-S with the piping length of 15m, indoor wet-bulb temperature at 19.0°C and outdoor dry-bulb temperature 35°C is Net cooling capacity =

$$\begin{array}{ccccccc}
 \frac{3.2}{\uparrow} & \times & \frac{0.975}{\uparrow} & \times & \frac{1.0}{\uparrow} & \doteq & 3.1\text{kW} \\
 \text{SRK35ZMP-S} & & \text{Length 15m} & & \text{Factor by air} & & \\
 & & & & \text{temperatures} & &
 \end{array}$$

7. CAPACITY TABLES

Model SRK25ZMP-S

Cooling Mode

(kW)

Air flow	Outdoor air temp.	Indoor air temp													
		21°CDB		23°CDB		26°CDB		27°CDB		28°CDB		31°CDB		33°CDB	
		14°CWB	16°CWB	18°CWB	19°CWB	20°CWB	22°CWB	24°CWB	TC	SHC	TC	SHC	TC	SHC	TC
Hi 10.1 (m ³ /min)	10	2.82	2.36	2.95	2.32	3.06	2.42	3.11	2.39	3.16	2.36	3.26	2.46	3.34	2.39
	12	2.77	2.34	2.90	2.30	3.01	2.40	3.07	2.37	3.12	2.35	3.22	2.45	3.31	2.38
	14	2.71	2.31	2.85	2.27	2.97	2.39	3.03	2.36	3.08	2.33	3.18	2.43	3.28	2.37
	16	2.66	2.28	2.80	2.25	2.92	2.37	2.98	2.35	3.04	2.32	3.15	2.42	3.24	2.36
	18	2.60	2.26	2.74	2.23	2.88	2.35	2.94	2.33	2.99	2.31	3.11	2.41	3.20	2.35
	20	2.55	2.23	2.68	2.21	2.83	2.33	2.89	2.31	2.95	2.29	3.07	2.39	3.17	2.34
	22	2.49	2.20	2.63	2.18	2.78	2.31	2.84	2.29	2.90	2.27	3.02	2.38	3.13	2.32
	24	2.43	2.18	2.57	2.15	2.72	2.29	2.80	2.27	2.85	2.25	2.98	2.36	3.08	2.31
	26	2.37	2.14	2.51	2.13	2.67	2.27	2.74	2.25	2.80	2.23	2.93	2.35	3.04	2.29
	28	2.31	2.12	2.44	2.10	2.61	2.24	2.69	2.23	2.75	2.21	2.89	2.33	3.00	2.28
	30	2.24	2.09	2.38	2.07	2.56	2.22	2.64	2.21	2.70	2.19	2.84	2.31	2.95	2.27
	32	2.18	2.06	2.31	2.04	2.50	2.20	2.58	2.19	2.64	2.17	2.79	2.30	2.90	2.25
	34	2.11	2.03	2.25	2.01	2.44	2.18	2.53	2.17	2.59	2.15	2.74	2.28	2.85	2.24
	35	2.08	2.01	2.21	2.00	2.41	2.16	2.50	2.16	2.56	2.14	2.71	2.27	2.83	2.23
	36	2.04	1.99	2.18	1.98	2.38	2.15	2.47	2.14	2.53	2.13	2.69	2.26	2.80	2.22
	38	1.97	1.97	2.11	1.95	2.32	2.12	2.41	2.12	2.47	2.11	2.63	2.24	2.75	2.20
	39	1.94	1.94	2.07	1.94	2.28	2.11	2.38	2.11	2.44	2.10	2.61	2.23	2.72	2.20

Heating Mode(HC)

(kW)

Air flow	Outdoor air temp.	Indoor air temp				
		16°CDB	18°CDB	20°CDB	22°CDB	24°CDB
		Hi 9.5 (m ³ /min)	-15°CWB	1.72	1.69	1.65
-10°CWB	1.95		1.91	1.89	1.84	1.80
-5°CWB	2.11		2.08	2.04	2.02	1.98
0°CWB	2.21		2.18	2.14	2.12	2.09
5°CWB	2.82		2.79	2.77	2.72	2.68
6°CWB	2.87		2.83	2.80	2.76	2.73
10°CWB	3.04		3.02	3.00	2.96	2.93
15°CWB	3.31		3.28	3.26	3.23	3.20
20°CWB	3.56		3.53	3.52	3.48	3.45

Model SRK35ZMP-S

Cooling Mode

(kW)

Air flow	Outdoor air temp.	Indoor air temp													
		21°CDB		23°CDB		26°CDB		27°CDB		28°CDB		31°CDB		33°CDB	
		14°CWB	16°CWB	18°CWB	19°CWB	20°CWB	22°CWB	24°CWB	TC	SHC	TC	SHC	TC	SHC	TC
Hi 9.5 (m ³ /min)	10	3.61	2.75	3.77	2.70	3.91	2.80	3.98	2.76	4.05	2.72	4.17	2.79	4.28	2.70
	12	3.54	2.72	3.71	2.67	3.86	2.77	3.93	2.73	4.00	2.70	4.12	2.77	4.24	2.68
	14	3.47	2.69	3.65	2.64	3.80	2.74	3.87	2.71	3.94	2.67	4.08	2.75	4.19	2.67
	16	3.40	2.65	3.58	2.61	3.74	2.72	3.82	2.68	3.89	2.64	4.03	2.74	4.15	2.65
	18	3.33	2.61	3.51	2.57	3.68	2.68	3.76	2.66	3.83	2.62	3.98	2.71	4.10	2.64
	20	3.26	2.58	3.44	2.54	3.62	2.66	3.70	2.63	3.78	2.60	3.92	2.69	4.05	2.61
	22	3.19	2.54	3.36	2.51	3.55	2.63	3.64	2.61	3.71	2.58	3.87	2.68	4.00	2.59
	24	3.11	2.50	3.29	2.47	3.49	2.60	3.58	2.58	3.65	2.56	3.81	2.64	3.95	2.58
	26	3.03	2.46	3.21	2.43	3.42	2.57	3.51	2.55	3.59	2.53	3.76	2.62	3.89	2.56
	28	2.95	2.42	3.13	2.39	3.35	2.54	3.45	2.53	3.52	2.50	3.70	2.61	3.84	2.55
	30	2.87	2.38	3.05	2.35	3.27	2.51	3.38	2.50	3.45	2.47	3.64	2.59	3.78	2.52
	32	2.79	2.34	2.96	2.32	3.20	2.48	3.31	2.47	3.38	2.45	3.57	2.56	3.72	2.51
	34	2.70	2.30	2.88	2.28	3.12	2.45	3.24	2.44	3.31	2.42	3.51	2.54	3.65	2.48
	35	2.66	2.27	2.83	2.26	3.08	2.43	3.20	2.43	3.28	2.40	3.47	2.52	3.62	2.47
	36	2.61	2.25	2.79	2.24	3.04	2.41	3.16	2.41	3.24	2.39	3.44	2.51	3.59	2.46
	38	2.52	2.21	2.70	2.20	2.96	2.38	3.09	2.38	3.16	2.36	3.37	2.49	3.52	2.44
	39	2.48	2.19	2.65	2.18	2.92	2.36	3.05	2.36	3.12	2.34	3.34	2.48	3.49	2.43

Heating Mode(HC)

(kW)

Air flow	Outdoor air temp.	Indoor air temp				
		16°CDB	18°CDB	20°CDB	22°CDB	24°CDB
		Hi 9.6 (m ³ /min)	15°CWB	2.21	2.17	2.12
-10°CWB	2.51		2.46	2.43	2.37	2.32
-5°CWB	2.71		2.68	2.62	2.59	2.55
0°CWB	2.85		2.80	2.76	2.72	2.68
5°CWB	3.63		3.58	3.56	3.49	3.44
6°CWB	3.68		3.64	3.60	3.55	3.51
10°CWB	3.91		3.88	3.85	3.80	3.76
15°CWB	4.26		4.22	4.19	4.15	4.11
20°CWB	4.58		4.54	4.52	4.47	4.43

Model SRK45ZMP-S

Cooling Mode

(kW)

Air flow	Outdoor air temp.	Indoor air temp													
		21 °CDB		23 °CDB		26 °CDB		27 °CDB		28 °CDB		31 °CDB		33 °CDB	
		14 °CWB	16 °CWB	18 °CWB	19 °CWB	20 °CWB	22 °CWB	24 °CWB	TC	SHC	TC	SHC	TC	SHC	TC
Hi 9.0 (m ³ /min)	10	5.07	3.57	5.31	3.52	5.50	3.58	5.59	3.53	5.69	3.47	5.86	3.50	6.02	3.36
	12	4.98	3.52	5.22	3.47	5.42	3.54	5.52	3.49	5.62	3.43	5.80	3.47	5.96	3.34
	14	4.88	3.47	5.13	3.42	5.34	3.50	5.45	3.45	5.55	3.40	5.73	3.43	5.90	3.31
	16	4.79	3.41	5.03	3.37	5.26	3.45	5.37	3.41	5.47	3.36	5.66	3.41	5.83	3.29
	18	4.69	3.35	4.93	3.31	5.18	3.41	5.29	3.37	5.39	3.32	5.59	3.38	5.77	3.26
	20	4.59	3.30	4.83	3.26	5.09	3.36	5.20	3.32	5.31	3.28	5.52	3.34	5.70	3.23
	22	4.48	3.23	4.73	3.20	5.00	3.31	5.12	3.28	5.22	3.24	5.44	3.31	5.63	3.20
	24	4.37	3.18	4.62	3.14	4.90	3.27	5.03	3.24	5.14	3.20	5.36	3.27	5.55	3.17
	26	4.26	3.11	4.51	3.08	4.80	3.22	4.94	3.20	5.05	3.16	5.28	3.24	5.48	3.14
	28	4.15	3.05	4.40	3.02	4.70	3.17	4.85	3.15	4.95	3.12	5.20	3.20	5.40	3.10
	30	4.04	2.98	4.28	2.96	4.60	3.12	4.75	3.11	4.86	3.07	5.11	3.16	5.31	3.08
	32	3.92	2.92	4.16	2.90	4.50	3.06	4.65	3.06	4.76	3.02	5.02	3.13	5.23	3.04
	34	3.80	2.85	4.04	2.84	4.39	3.02	4.55	3.01	4.66	2.98	4.93	3.09	5.14	3.01
	35	3.74	2.82	3.98	2.80	4.34	2.99	4.50	2.99	4.61	2.96	4.88	3.07	5.09	3.00
	36	3.67	2.79	3.92	2.78	4.28	2.96	4.45	2.96	4.55	2.93	4.84	3.05	5.05	2.98
	38	3.55	2.72	3.79	2.71	4.17	2.91	4.34	2.92	4.45	2.89	4.74	3.01	4.95	2.94
	39	3.48	2.69	3.73	2.68	4.11	2.88	4.29	2.89	4.39	2.86	4.69	2.99	4.90	2.92

Heating Mode(HC)

(kW)

Air flow	Outdoor air temp.	Indoor air temp				
		16°C DB	18°C DB	20°C DB	22°C DB	24°C DB
		Hi 12.0 (m ³ /min)	-15°CWB	3.08	3.01	2.94
-10°CWB	3.48		3.42	3.37	3.29	3.22
-5°CWB	3.77		3.72	3.64	3.60	3.54
0°CWB	3.95		3.89	3.83	3.78	3.73
5°CWB	5.04		4.98	4.95	4.85	4.78
6°CWB	5.12		5.06	5.00	4.94	4.88
10°CWB	5.44		5.38	5.35	5.28	5.23
15°CWB	5.92		5.87	5.82	5.76	5.71
20°CWB	6.36		6.31	6.28	6.21	6.16

Note(1) These data show average statuses.
Depending on the system control, there may be ranges where the operation is not conducted continuously.
These data show the case where the operation frequency of a compressor is fixed.
(2) Capacities are based on the following conditions.
Corresponding refrigerant piping length :7m
Level difference of Zero.
(3) Symbols are as follows.
TC : Total cooling capacity (kW)
SHC : Sensible heat capacity (kW)
HC : Heating capacity (kW)

8. APPLICATION DATA

Models SRK25ZMP-S, 35ZMP-S, 45ZMP-S

RLC012A001A

WALL TYPE AIR CONDITIONER
R410A REFRIGERANT USED

- When install the unit, be sure to check whether the selection of installation place, power supply specifications, usage limitation (piping length, height differences between indoor and outdoor units, power supply voltage and etc.) and installation spaces.

SAFETY PRECAUTIONS

- Read the "SAFETY PRECAUTIONS" carefully first of all and strictly follow it during the installation work in order to protect yourself.
- The precautionary items mentioned below are distinguished into two levels, **⚠ WARNING** and **⚡ CAUTION**.
⚠ WARNING : Wrong installation would cause serious consequences such as injuries or death.
⚡ CAUTION : Wrong installation might cause serious consequences depending on circumstances.
 Both mentions the important items to protect your health and safety so strictly follow them by any means.
- Be sure to confirm no anomaly on the equipment by commissioning after completed installation and explain the operating methods as well as the maintenance methods of this equipment to the user according to the owner's manual.
- Keep the installation manual together with owner's manual at a place where any user can read at any time.

- Moreover if necessary, ask to hand them to a new user.
- For installing qualified personnel, take precautions in respect to themselves by using suitable protective clothing, groves, etc., and then perform the installation works.
- Please pay attention not to fall down the tools, etc. when installing the unit at the high position.
- If unusual noise can be heard during operation, consult the dealer.
- The meanings of "Marks" used here are shown as follows:

⊘	Never do it under any circumstances.	⚠	⚡	Always do it according to the instruction.
---	--------------------------------------	---	---	--

⚠ WARNING

⚠	<ul style="list-style-type: none"> • Installation must be carried out by the qualified installer. If you install the system by yourself, it may cause serious trouble such as water leaks, electric shocks, fire and personal injury, as a result of a system malfunction. Do not carry out the installation and maintenance work except the by qualified installer. • Install the system in full accordance with the installation manual. Incorrect installation may cause bursts, personal injury, water leaks, electric shocks and fire. • Be sure to use only for household and residence. If this appliance is installed in inferior environment such as machine shop and etc., it can cause malfunction. • Use the original accessories and the specified components for installation. If parts other than those prescribed by us are used, it may cause water leaks, electric shocks, fire and personal injury. • Install the unit in a location with good support. Unsuitable installation locations can cause the unit to fall and cause material damage and personal injury. • Ensure the unit is stable when installed, so that it can withstand earthquakes and strong winds. Unsuitable installation locations can cause the unit to fall and cause material damage and personal injury. • Ventilate the working area well in the event of refrigerant leakage during installation. If the density of refrigerant exceeds the limit, please consult the dealer and install the ventilation system, otherwise lack of oxygen can occur, which can cause serious accident. • When installing in small rooms, take prevention measures not to exceed the density limit of refrigerant in the event of leakage, referred by the formula (accordance with ISO5149). If the density of refrigerant exceeds the limit, please consult the dealer and install the 	<ul style="list-style-type: none"> ventilation system, otherwise lack of oxygen can occur, which can cause serious accident. • After completed installation, check that no refrigerant leaks from the system. If refrigerant leaks into the room and comes into contact with an oven or other hot surface, poisonous gas is produced. • Use the prescribed pipes, flare nuts and tools for R410A. Using existing parts (for R22 or R407C) can cause the unit failure and serious accidents due to burst of the refrigerant circuit. • Tighten the flare nut by torque wrench with specified method. If the flare nut were tightened with excess torque, this may cause burst and refrigerant leakage after a long period. • Do not open the operation valves for liquid line and gas line until completed refrigerant piping work, air tightness test and evacuation. If the compressor is operated in state of opening operation valves before completed connection of refrigerant piping work, air can be sucked into refrigerant circuit, which can cause burst or personal injury due to anomalously high pressure in the refrigerant. • The electrical installation must be carried out by the qualified electrician in accordance with "the norm for electrical work" and "national wiring regulation", and the system must be connected to the dedicated circuit. Power supply with insufficient capacity and incorrect function done by improper work can cause electric shocks and fire. • Be sure to shut off the power before starting electrical work. Failure to shut off the power can cause electric shocks, unit failure or incorrect function of equipment. • Be sure to use the cables conformed to safety standard and cable ampacity for power distribution work. Unconformable cables can cause electric leak, anomalous heat production or fire. • This appliance must be connected to main power supply by means of a circuit breaker or switch (fuse:16A) with a contact separation of at least 3mm. high, which can cause burst and personal injury. 	<ul style="list-style-type: none"> • When plugging this appliance, a plug conforming to the norm IEC60884-1 must be used. • Use the prescribed cables for electrical connection, tighten the cables securely in terminal block and relieve the cables correctly to prevent overloading the terminal blocks. Loose connections or cable mountings can cause anomalous heat production or fire. • Arrange the wiring in the control box so that it cannot be pushed up further into the box. Install the service panel correctly. Incorrect installation may result in overheating and fire. • Be sure to fix up the service panels. Loose fixing can cause electric shocks or fire due to intrusion of dust or water. • Be sure to switch off the power supply in the event of installation, inspection or servicing. If the power supply is not shut off, there is a risk of electric shocks, unit failure or personal injury due to the unexpected start of fan. • Stop the compressor before removing the pipe after shutting the service valve on pump down work. If the pipe is removed when the compressor is in operation with the service valve open, air would be mixed in the refrigeration circuit and it could cause explosion and injuries due to abnormal high pressure in the cooling cycle. • Only use prescribed option parts. The installation must be carried out by the qualified installer. If you install the system by yourself, it can cause serious trouble such as water leaks, electric shocks, fire. • Be sure to wear protective goggles and gloves while at work. • Earth leakage breaker must be installed. If the earth leakage breaker is not installed, it can cause electric shocks.
⊘	<ul style="list-style-type: none"> • Do not put the drainage pipe directly into drainage channels where poisonous gases such as sulphide gas can occur. Poisonous gases will flow into the room through drainage pipe and seriously affect the user's health and safety. This can also cause the corrosion of the indoor unit and a resultant unit failure or refrigerant leak. • Ensure that no air enters in the refrigerant circuit when the unit is installed and removed. If air enters in the refrigerant circuit, the pressure in the refrigerant circuit becomes too 	<ul style="list-style-type: none"> Do not processing, splice the power cord, or share a socket with other power plugs. This may cause fire or electric shock due to defecting contact, defecting insulation and over-current etc. • Do not bundling, winding or processing for the power cord. Or, do not deforming the power plug due to tread it. This may cause fire or heating. 	<ul style="list-style-type: none"> • Do not vent R410A into the atmosphere : R410A is a fluorinated greenhouse gas, covered by the Kyoto Protocol with Global Warming Potential (GWP)=1975. • Do not run the unit with removed panels or protections. Touching rotating equipments, hot surfaces or high voltage parts can cause personal injury due to entrapment, burn or electric shocks. • Do not perform any change of protective device itself or its setup condition. The forced operation by short-circuiting protective device of pressure switch and temperature controller or the use of non specified component can cause fire or burst.

⚠ CAUTION

⚡	<ul style="list-style-type: none"> • Carry out the electrical work for ground lead with care. Do not connect the ground lead to the gas line, water line, lightning conductor or telephone line's ground lead. Incorrect grounding can cause unit faults such as electric shocks due to short-circuiting. 	
!	<ul style="list-style-type: none"> • Use the circuit breaker of correct capacity. Circuit breaker should be the one that disconnect all poles under over current. Using the incorrect one could cause the system failure and fire. • Install isolator or disconnect switch on the power supply wiring in accordance with the local codes and regulations. The isolator should be locked in OFF state in accordance with EN60204-1. • Be sure to install indoor unit properly according to the instruction manual in order to run off the drainage smoothly. Improper installation of indoor unit can cause dropping water into the room and damaging personal property. • Install the drainage pipe to run off drainage securely according to the installation manual. Incorrect installation of the drainage pipe can cause dropping water into the room and damaging personal property. • Be sure to install the drainage pipe with descending slope of 1/100 or more, and not to make traps and air-bleedings. Check if the drainage runs off securely during commissioning and ensure the space for 	<p>inspection and maintenance.</p> <ul style="list-style-type: none"> • After maintenance, all wiring, wiring ties and the like, should be returned to their original state and wiring route, and the necessary clearance from all metal parts should be secured. • Secure a space for installation, inspection and maintenance specified in the manual. Insufficient space can result in accident such as personal injury due to falling from the installation place. • Take care when carrying the unit by hand. If the unit weights more than 20kg, it must be carried by two or more persons. Do not carry by the plastic straps, always use the carry handle when carrying the unit by hand. Use gloves to minimize the risk of cuts by the aluminum fins. • Dispose of any packing materials correctly. Any remaining packing materials can cause personal injury as it contains nails and wood. And to avoid danger of suffocation, be sure to keep the plastic wrapper away from children and to dispose after tear it up. • For installation work, be careful not to get injured with the heat exchanger,
⊘	<ul style="list-style-type: none"> • Do not install the unit in the locations listed below. <ul style="list-style-type: none"> • Locations where carbon fiber, metal powder or any powder is floating. • Locations where any substances that can affect the unit such as sulphide gas, chloride gas, acid and alkaline can occur. • Vehicles and ships. • Locations where cosmetic or special sprays are often used. • Locations with direct exposure of oil mist and steam such as kitchen and machine plant. • Locations where any machines which generate high frequency harmonics are used. • Locations with salty atmospheres such as coastlines. • Locations with heavy snow (If installed, be sure to provide base flame and snow hood mentioned in the manual). • Locations where the unit is exposed to chimney smoke. • Locations at high altitude (more than 1000m high). • Locations with ammoniac atmospheres. • Locations where heat radiation from other heat source can affect the unit. • Locations without good air circulation. • Locations with any obstacles which can prevent inlet and outlet air of the unit. • Locations where short circuit of air can occur (in case of multiple units installation). • Locations where strong air blows against the air outlet of outdoor unit. • Locations where something located above the unit could fall. • It can cause remarkable decrease in performance, corrosion and damage of components, malfunction and fire. • Do not install the indoor unit in the locations listed below (Be sure to install the indoor unit according to the installation manual for each model because each indoor unit has each limitation). <ul style="list-style-type: none"> • Locations with any obstacles which can prevent inlet and outlet air of the unit. • Locations where vibration can be amplified due to insufficient strength of structure. • Locations where the infrared receiver is exposed to the direct sunlight or the strong light beam (in case of the infrared specification unit). • Locations where an equipment affected by high harmonics is placed (TV set or radio receiver is placed within 1m). • Locations where drainage cannot run off safely. 	<p>It can affect performance or function and etc.</p> <ul style="list-style-type: none"> • Do not install the outdoor unit in the locations listed below. <ul style="list-style-type: none"> • Locations where discharged hot air or operating sound of the outdoor unit can bother neighborhood. • Locations where outlet air of the outdoor unit blows directly to plants. The outlet air can affect adversely to the plant etc. • Locations where vibration can be amplified and transmitted due to insufficient strength of structure. • Locations where vibration and operation sound generated by the outdoor unit can affect seriously (on the wall or at the place near bed room). • Locations where an equipment affected by high harmonics is placed (TV set or radio receiver is placed within 1m). • Locations where drainage cannot run off safely. • It can affect surrounding environment and cause a claim. • Do not install the unit near the location where leakage of combustible gases can occur. If leaked gases accumulate around the unit, it can cause fire. • Do not install the unit where corrosive gas (such as sulfuric acid gas etc.) or combustible gas (such as thinner and petroleum gases) can accumulate or collect, or where volatile combustible substances are handled. Corrosive gas can cause corrosion of heat exchanger, breakage of plastic parts and etc. And combustible gas can cause fire. • Do not use the indoor unit at the place where water splashes may occur such as in laundries. Since the indoor unit is not waterproof, it can cause electric shocks and fire. • Do not install nor use the system close to the equipment that generates electromagnetic fields or high frequency harmonics. Equipment such as inverters, standby generators, medical high frequency equipments and telecommunication equipments can affect the system, and cause malfunctions and breakdowns. The system can also affect medical equipment and telecommunication equipment, and obstruct its function or cause jamming.
		<ul style="list-style-type: none"> • Do not place any variables which will be damaged by getting wet under the indoor unit. When the relative humidity is higher than 80% or drainage pipe is clogged, condensation or drainage water can drop and it can cause the damage of valuables. • Do not install the remote control at the direct sunlight. It can cause malfunction or deformation of the remote control. • Do not use the unit for special purposes such as storing foods, cooling precision instruments and preservation of animals, plants or art. It can cause the damage of the items. • Do not install the outdoor unit in a location where insects and small animals can inhabit. Insects and small animals can enter the electric parts and cause damage or fire. Instruct the user to keep the surroundings clean. • Do not use the base flame for outdoor unit which is corroded or damaged due to long periods of operation. Using an old and damage base flame can cause the unit falling down and cause personal injury. • Do not use any materials other than a fuse with the correct rating in the location where fuses are to be used. Connecting the circuit with copper wire or other metal thread can cause unit failure and fire. • Do not touch any buttons with wet hands. It can cause electric shocks. • Do not touch any refrigerant pipes with your hands when the system is in operation. During operation the refrigerant pipes become extremely hot or extremely cold depending the operating condition, and it can cause burn injury or frost injury. • Do not touch the suction or aluminum fin on the outdoor unit. This may cause injury. • Do not put anything on the outdoor unit and operating unit. This may cause damage the objects or injury due to falling to the object. • Do not use the unit for special purposes such as storing foods, cooling precision instruments and preservation of animals, plants or art. • Do not clean up the unit with water.

Check before installation work

- Model name and power source • Refrigerant piping length • Piping, wiring and miscellaneous small parts

Standard accessories (installation kit)		Accessories for indoor unit	
	Qty		Qty
① Installation board (Attached to the rear of the indoor unit)	1	⑤ Wood screws (for remote control holder ø3.5 X 16mm)	2
② Wireless remote control	1	⑥ Battery [R03 (AAA, Micro) 1.5V]	2
③ Remote control holder	1	Accessories for outdoor unit	
④ Tapping screws (for installation board ø4 X 25mm)	5	⑦ Grommet	1
		⑧ Drain elbow (Heat pump type only)	1

Option parts		Qty
④ Sealing plate		1
⑤ Sleeve		1
⑥ Inclination plate		1
⑦ Putty		1
⑧ Drain hose (extension hose)		1
⑨ Piping cover (for insulation of connection piping)		1

Necessary tools for the installation work		Qty
1 Plus headed driver		10
2 Knife		11
3 Saw		12
4 Tape measure		13
5 Hammer		14
6 Spanner wrench		15
7 Torque wrench [14.0~62.0N·m (1.4~6.2kgf·m)]		16
8 Hole core drill (65mm in diameter)		17
9 Wrench key (Hexagon) [4m/m]		17
10 Vacuum pump		
11 Vacuum pump adapter (Anti-reverse flow type) (Designed specifically for R410A)		
12 Gauge manifold (Designed specifically for R410A)		
13 Charge hose (Designed specifically for R410A)		
14 Flaring tool set (Designed specifically for R410A)		
15 Gas leak detector (Designed specifically for R410A)		
16 Gauge for projection adjustment (Used when flare is made by using conventional flare tool)		
17 Pipe bender		

SELECTION OF INSTALLATION LOCATION

(Install at location that meets the following conditions, after getting approval from the customer)

Indoor unit

- Where there is no obstructions to the air flow and where the cooled and heated air can be evenly distributed.
- A solid place where the unit or the wall will not vibrate.
- A place where there will be enough space for servicing. (Where space mentioned right can be secured)
- Where wiring and the piping work will be easy to conduct.
- The place where receiving part is not exposed to the direct rays of the sun or the strong rays of the street lighting.
- A place where it can be easily drained.
- A place separated at least 1m away from the TV or the radio. (To prevent interference to images and sounds.)
- Places where this unit is not affected by the high frequency equipment or electric equipment.
- Avoid installing this unit in place where there is much oil mist.
- Places where there is no electric equipment or household under the installing unit.

Wireless remote control

- A place where the air conditioner can be received the signal surely during operating the wireless remote control.
- Places where there is no affected by the TV and radio etc.
- Do not place where exposed to direct sunlight or near heat devices such as a stove.

Outdoor unit

- Where air is not trapped.
- Where the installation fittings can be firmly installed.
- Where wind does not hinder the intake and outlet pipes.
- Out of the heat range of other heat sources.
- A place where stringent regulation of electric noises is applicable.
- Where it is safe for the drain water to be discharged.
- Where noise and hot air will not bother neighboring residents.
- Where snow will not accumulate.
- Where strong winds will not blow against the outlet pipe.
- When the unit is installed, the space of the following dimension and above shall be secured.
(In case the barrier is 1.2m or above in height, or is overhead, the sufficient space between the unit and wall shall be secured.)

The height of a wall is 1200mm or less.

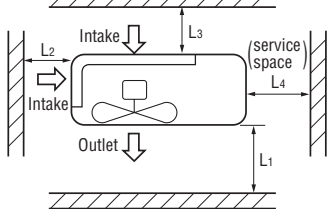

Example installation Size	I	II	III	IV
L1	Open	280	280	180
L2	100	100	Open	Open
L3	100	80	80	80
L4	250	Open	250	Open

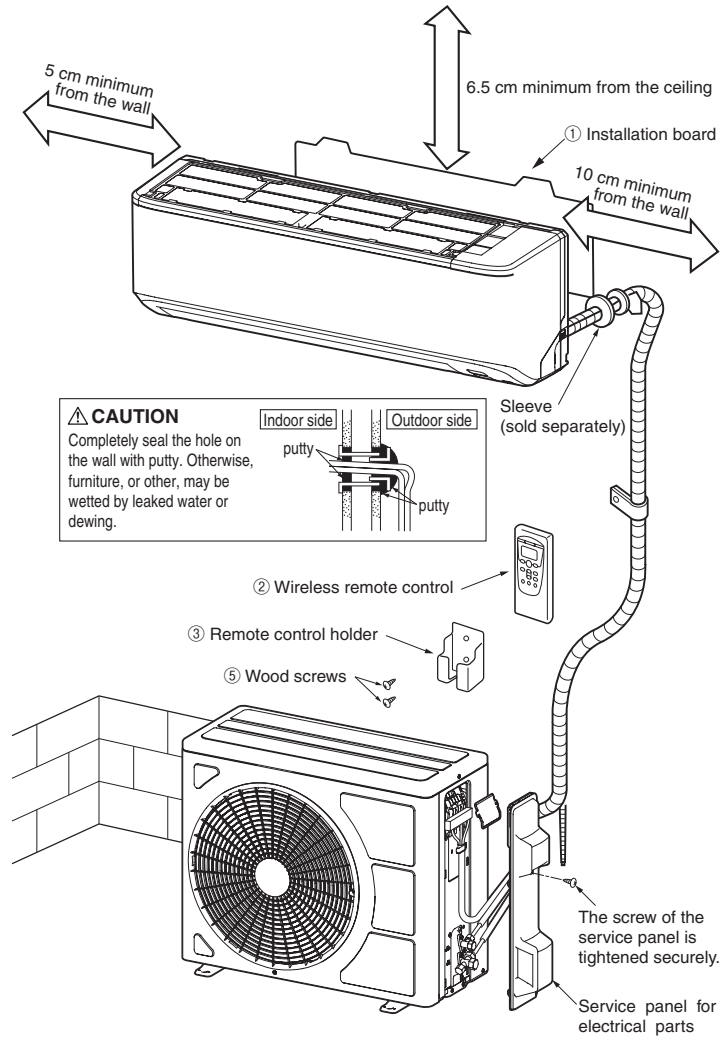

Limitation of the piping length

Model	SRK25, DXK09	SRK35, DXK12	SRK45, DXK15
Total one way length	MAX. 15m	MAX. 15m	MAX. 25m
Vertical height difference	MAX. 10m	MAX. 10m	MAX. 15m
Additional refrigerant	Less than 10m : Not required More than 10m : 20g/m	Not required	Less than 15m : Not required More than 15m : 20g/m

HOW TO RELOCATE OR DISPOSE OF THE UNIT

- In order to protect the environment, be sure to pump down (recovery of refrigerant).
- Pump down is the method of recovering refrigerant from the indoor unit to the outdoor unit when the pipes are removed from the unit.

<How to pump down>

- ① Connect charge hose to check joint.
- ② Liquid side : Close the liquid valve with hexagon wrench key.
Gas side : Fully open the gas valve.
Carry out cooling operation. (If indoor temperature is low, operate forced cooling operation.)
- ③ After low pressure gauge become 0.01MPa, stop cooling operation and close the gas valve.

● Forced cooling operation

Turn on a power supply again after a while after turn off a power supply.
Then press continually the ON/OFF button 5 seconds or more.

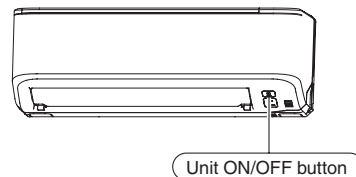

INSTALLATION OF WIRELESS REMOTE CONTROL

Mounting method of battery

- Uncover the wireless remote control, and mount the batteries [R03 (AAA, Micro), × 2 pieces] in the body regularly. (Fit the poles with the indication marks, ⊕ & ⊖ without fail)

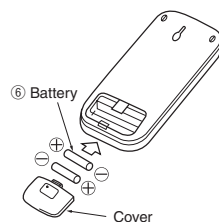

⚠ CAUTION

Do not use new and old batteries together.

Fixing to pillar or wall

- Conventionally, operate the wireless remote control by holding in your hand.
- Avoid installing it on a clay wall etc.

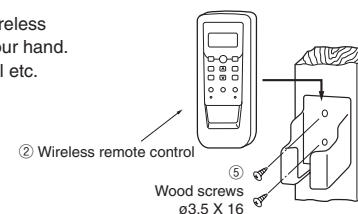

EARTHING WORK

- Earth work shall be carried out without fail in order to prevent electric shock and noise generation.
- The connection of the earth cable to the following substances causes dangerous failures, therefore it shall never be done. City water pipe, Town gas pipe, TV antenna, lightning conductor, telephone line, etc.

How to remove and install the front panel

- Removing
 - ① Remove the 2 set screws.
 - ② Remove the 3 latches in the upper section. And take off the front panel.
- Installing
 - ① Cover the body with the front panel. And lock the latches (on the base).
 - ② Tighten the 2 set screws.
 - ③ Carry out in the above order.

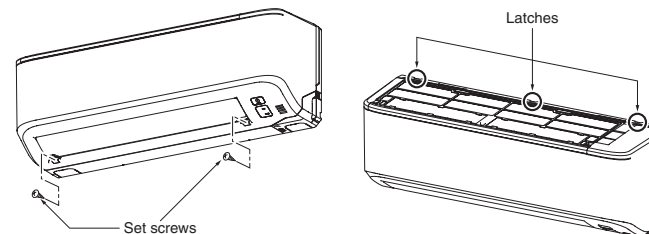

INSTALLATION OF INDOOR UNIT

Installation of Installation board

Fixing of installation board

Look for the inside wall structures (Intermediate support or pillar and firmly install the unit after level surface has been checked.)

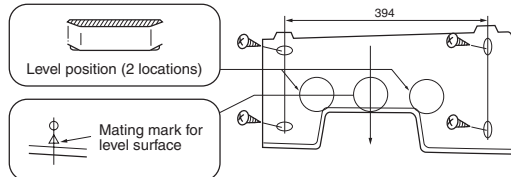

- Adjustment of the installation board in the horizontal direction is to be conducted with four screws in a temporary tightened state.
- Adjust so the board will be level by turning the board with the standard hole as the center.

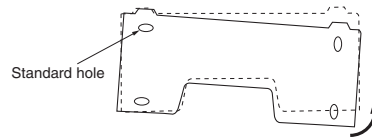

Drilling of holes and fixture of sleeve (Option parts)

When drilling the wall that contains a metal lath, wire lath or metal plate, be sure to use pipe hole sleeve sold separately.

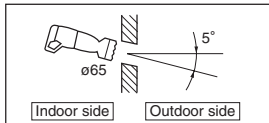

- Drill a hole with whole core drill.

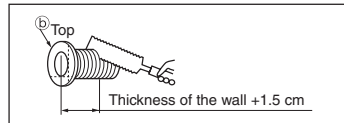

- In case of rear piping draw out, cut off the lower and the right side portions of the sleeve collar.

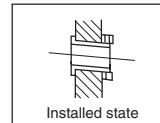
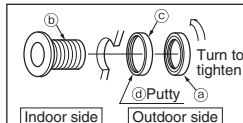

Preparation of indoor unit

Mounting of connecting wires

- Remove the lid.
- Remove the terminal cover.
- Remove the wiring clamp.
- Connect the connecting wire securely to the terminal block.
 - Connect the connection wire securely to the terminal block. If the wire is not affixed completely, contact will be poor, and it is dangerous as the terminal block may heat up and catch fire.
 - Take care not to confuse the terminal numbers for indoor and outdoor connections.
- Fix the connecting wire by wiring clamp.
- Attach the terminal cover.
- Attach the lid.

CAUTION

In case of faulty wiring connection, the indoor unit stops, and then the run lamp turns on and the timer lamp blinks.

Use cables for interconnection wiring to avoid loosening of the wires. CENELEC code for cables Required field cables.

H05RNR4G1.5 (Example) or 245ICE57

- H Harmonized cable type
- 05 300/500 volts
- R Natural-and/or synch. rubber wire insulation
- N Polychloroprene rubber conductors insulation
- R Stranded core
- 4 or 5 Number of conductors
- G One conductor of the cable is the earth conductor (yellow/green)
- 1.5 Section of copper wire (mm²)

Relation between setting plate and indoor unit

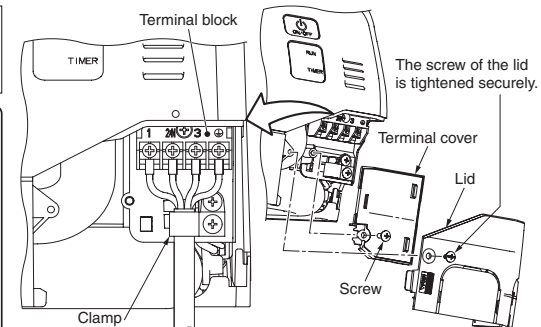
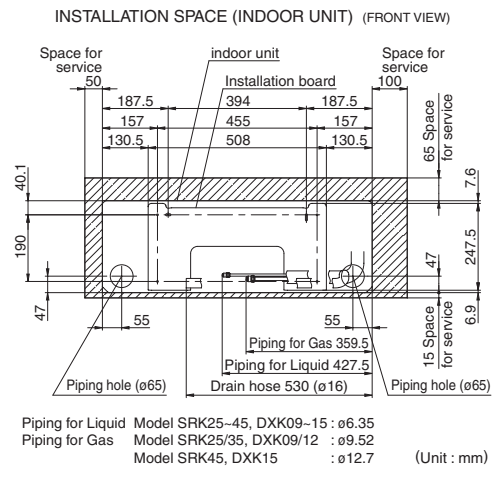

- Perform wiring, please take care of connecting the terminal number of outdoor unit terminal block.

Installing the support of piping

Piping is possible in the rear, left, left rear, left downward, right or downward direction.

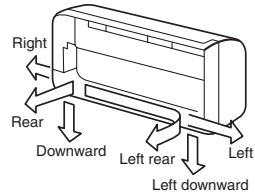

● Matters of special notice when piping from left or central/rear of the unit.

[Top view]

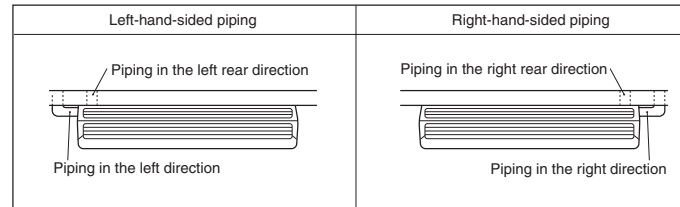

Since this air conditioner has been designed to collect dew drops on the rear surface to the drain pan, do not attach the power cord above the gutter.



Shaping of pipings

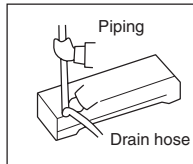

- Hold the bottom of the piping and fix direction before stretching it and shaping it.

Sufficient care must be taken not to damage the panel when connecting pipes.

Taping of the exterior

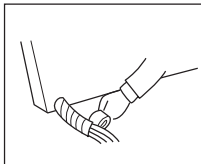

- Tape only the portion that goes through the wall.
- Always tape the wiring with the piping.

[Drain hose changing procedures]

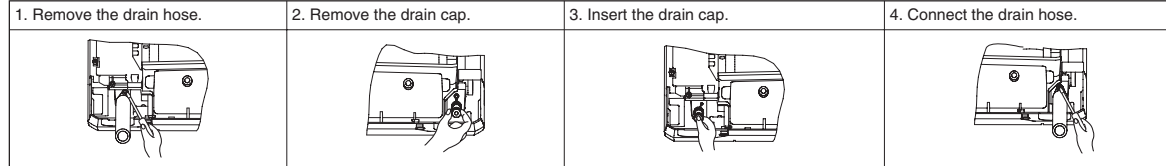

- Remove the screw and drain hose, making it rotate.
- Remove it with hand or pliers.
- Insert the drain cap which was removed at procedure "2" securely using a hexagonal wrench etc.
Note: Be careful that if it is not inserted securely, water leakage may occur.
- Insert the drain hose securely, making rotate. And install the screw.
Note: Be careful that if it is not inserted securely, water leakage may occur.

Drainage

- Arrange the drain hose in a downward angle.
- Avoid the following drain piping.



⚠ CAUTION

Go through all installation steps and check if the drainage is all right. Otherwise, water leak may occur.

- Pour water to the drain pan located under the heat exchanger, and ensure that the water is discharged outdoor.
- When the extended drain hose is indoor, securely insulate it with a heat insulator available in the market.

Fixing of indoor unit

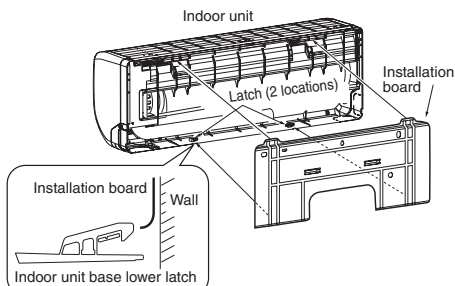

Installation Steps

- ① Pass the pipe through the hole in the wall, and hook the upper part of the indoor unit to the installation board.
- ② Gently push the lower part to secure the unit.

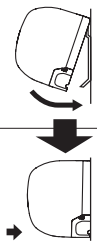

● How to remove the indoor unit from the installation board

- ① Push up at the marked portion of the indoor unit base lower latch, and slightly pull it toward you. (both right and left hand sides) (The indoor unit base lower latch can be removed from the installation board)
- ② Push up the indoor unit upward. So the indoor unit will be removed from the installation board.

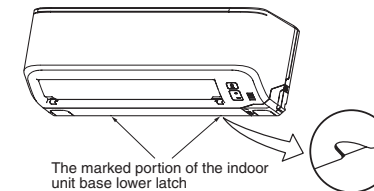

INSTALLATION OF THE OUTDOOR UNIT

Fixing of outdoor

- Make sure that the unit is stable in installation. Fix the unit to stable base.
- When installing the unit at a higher place or where it could be toppled by strong winds, secure the unit firmly with foundation bolts, wire, etc.

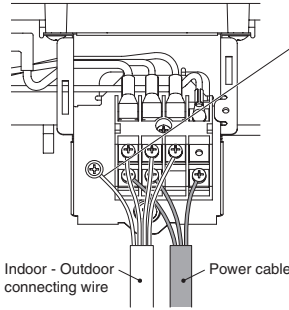

CAUTION

Please connect the earthed line of indoor and outdoor connecting wire to a bracket part of the illustration.

Electric wiring work

- Perform wiring, making wire terminal numbers conform to terminal numbers of indoor unit terminal block.
- Connect using ground screw located near ⊕ mark.
- Always perform grounding system installation work with the power cord unplugged.
- Connect a pair bearing a common terminal number with an indoor-outdoor connecting wire.
- In cabling, fasten cables securely with cable clamps so that no external force may work on terminal connections.
- Grounding terminals are provided in the control box.

power cable, indoor - outdoor connecting wire circuit diagram

CAUTION Always use an earth leakage circuit breaker designed for inverter circuits to prevent a faulty operation.

Phase	Model	Earth leakage breaker	Switchgear or Circuit Breaker		Power source (minimum)	Interconnecting and grounding wires (minimum)
			Switch breaker	Over current protector rated capacity		
Single-phase	SRK25 / DXK09	15A, 30mA, 0.1sec or less	30A	16A	2.0mm ²	1.5mm ² X 4
	SRK35 / DXK12					
	SRK45 / DXK15					

- The specifications shown in the above table are for units without heaters. For units with heaters, refer to the installation instructions or the construction instructions of the indoor unit.
- Switchgear or Circuit breaker capacity which is calculated from MAX. over current should be chosen along the regulations in each country.
- The cable specifications are based on the assumption that a metal or plastic conduit is used with no more than three cables contained in a conduit and a voltage drop is 2%. For an installation falling outside of these conditions, please follow the internal cabling regulations. Adapt it to the regulation in effect in each country.

Drain piping work

- Execute drain piping by using a drain elbow and drain grommets supplied separately as accessories, where water drained from the outdoor unit is a problem.
- Water may drip where there is a larger amount of drain water. Seal around the drain elbow and drain grommets with putty or adequate caulking material.
- Condensed water may flow out from vicinity of operation valve or connected pipes.
- Where you are likely to have several days of sub-zero temperatures in a row, do not use a drain elbow and drain grommets. (There is a risk of drain water freezing inside and blocking the drain.)

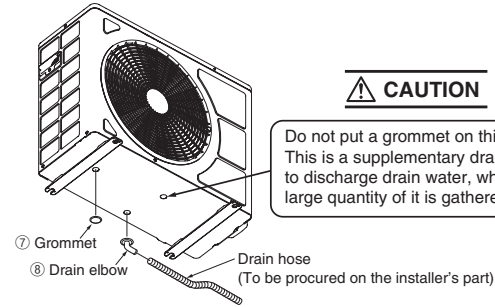

CAUTION

Do not put a grommet on this hole. This is a supplementary drain hole to discharge drain water, when a large quantity of it is gathered.

- When condensed water needs to be led to a drain, etc., install the unit on a flat base (supplied separately as an option part) or concrete blocks. Then, please secure space for the drain elbow and the drain hose.

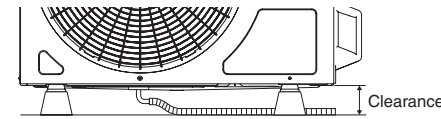

CONNECTION OF REFRIGERANT PIPINGS

Preparation Keep the openings of the pipes covered with tapes etc. to prevent dust, sand, etc. from entering them.

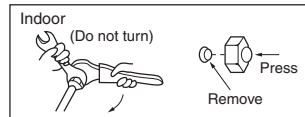

- Remove the flared nuts. (on both liquid and gas sides)

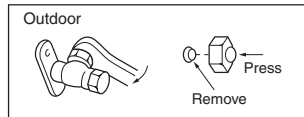

- Remove the flared nuts. (on both liquid and gas sides)

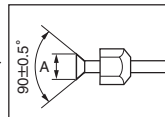

- Install the removed flared nuts to the pipes to be connected, then flare the pipes.

Dimension A (Unit : mm)
Liquid side : 9.1
Gas side Model SRK25/35, DXK09/12 : 13.2
Model SRK45, DXK15 : 16.6

CAUTION Do not apply refrigerating machine oil to the flared surface.

Flaring work

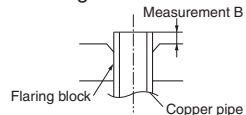

Copper pipe diameter	Measurement B (mm)		Use a flare tool designed for R410A or a conventional flare tool. Please note that measurement B (protrusion from the flaring block) will vary depending on the type of a flare tool in use. If a conventional flare tool is used, please use a copper pipe gauge or a similar instrument to check protrusion so that you can keep measurement B to a correct value.
	Clutch type flare tool for R410A	Conventional (R22) flare tool Clutch type Wing nut type	
φ 6.35	0.0~0.5	1.0~1.5 1.5~2.0	
φ 9.52	0.0~0.5	1.0~1.5 1.5~2.0	
φ 12.7	0.0~0.5	1.0~1.5 2.0~2.5	

Connection

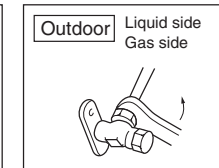
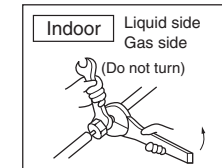

- Connect the pipes on both liquid and gas sides.
- Tighten the nuts to the following torque.
Liquid side(φ 6.35) : 14.0 ~ 18.0 N·m (1.4~1.8 kgf·m)
Gas side (φ 9.52) : 34.0 ~ 42.0 N·m (3.4~4.2 kgf·m)
(φ 12.7) : 49.0 ~ 61.0 N·m (4.9~6.1 kgf·m)

CAUTION

Do not apply excess torque to the flared nuts. Otherwise, the flared nuts may crack depending on the conditions and refrigerant leak may occur.

Air purge

- ① Tighten all flare nuts in the pipings both indoor and outside wall so as not to cause leak.
- ② Connect operation valve, charge hose, manifold valve and vacuum pump as is illustrated right.
- ③ Open manifold valve handle Lo to its full width, and perform vacuum or evacuation.
Continue the vacuum or evacuation operation for 15 minutes or more and check to see that the vacuum gauge reads -0.1MPa.
- ④ After completing vacuum operation, close the Lo handle and stop operation of the vacuum pump.
- ⑤ After completing vacuum operation, fully open operation valve (Both gas and liquid sides) with hexagon headed wrench.
- ⑥ Check for possible leakage of gas in the connection parts of both indoor and outdoor.

- Since the system uses check joints differing in diameter from those found on the conventional models, a charge hose (for R22) presently in use is not applicable. Please use one designed specifically for R410A.
- Please use an anti-reverse flow type vacuum pump adapter so as to prevent vacuum pump oil from running back into the system. Oil running back into an air-conditioning system may cause the refrigerant cycle to break down.

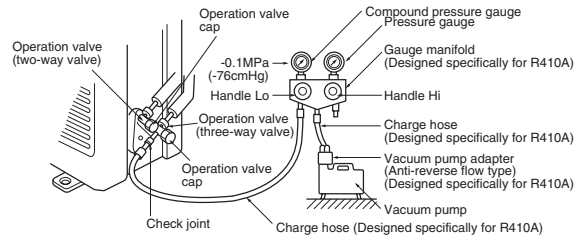

Securely tighten the operation valve cap and the check joint blind nut after adjustment.

Operation valve size (mm)	Operation valve cap tightening torque (N·m)	Check joint blind nut tightening torque ()
φ 6.35 (1/4")	20~30	10~12
φ 9.52 (3/8")		
φ 12.7 (1/2")	25~35	

Insulation of the connection portion

Cover the coupling with insulator and then cover it with tape.

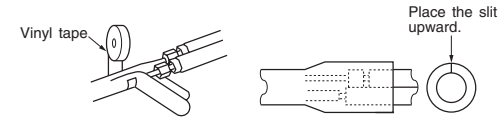

Finishing work and fixing

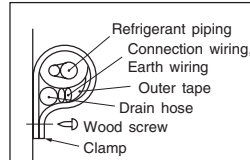

Cover the exterior portion with outer tape and shape the piping so it will match the contours of the route that the piping to take. Also fix the wiring and pipings to the wall with clamps.

INSTALLATION TEST CHECK POINTS

Check the following points again after completion of the installation, and before turning on the power. Conduct a test run again and ensure that the unit operates properly. At the same time, explain to the customer how to use the unit and how to take care of the unit following the instruction manual.

After installation

- The power supply voltage is correct as the rating.
- No gas leaks from the joints of the operation valve.
- Power cables and crossover wires are securely fixed to the terminal board.
- The screw of the lid is tightened securely.
- The screw of the service panel is tightened securely.
- Operation valve is fully open.
- The pipe joints for indoor and outdoor pipes have been insulated.

Test run

- Air conditioning operation is normal.
- No abnormal noise.
- Water drains smoothly.
- Protective functions are not working.
- The remote control is normal.

- Operation of the unit has been explained to the customer.

(Three-minute restart preventive timer)

When the air conditioner is restarted or when changing the operation, the unit will not start operating for approximately 3 minutes. This is to protect the unit and it is not a malfunction.

9. OUTLINE OF OPERATION CONTROL BY MICROCOMPUTER

(1) Operation control function by remote control

Remote control

◆ Operation section

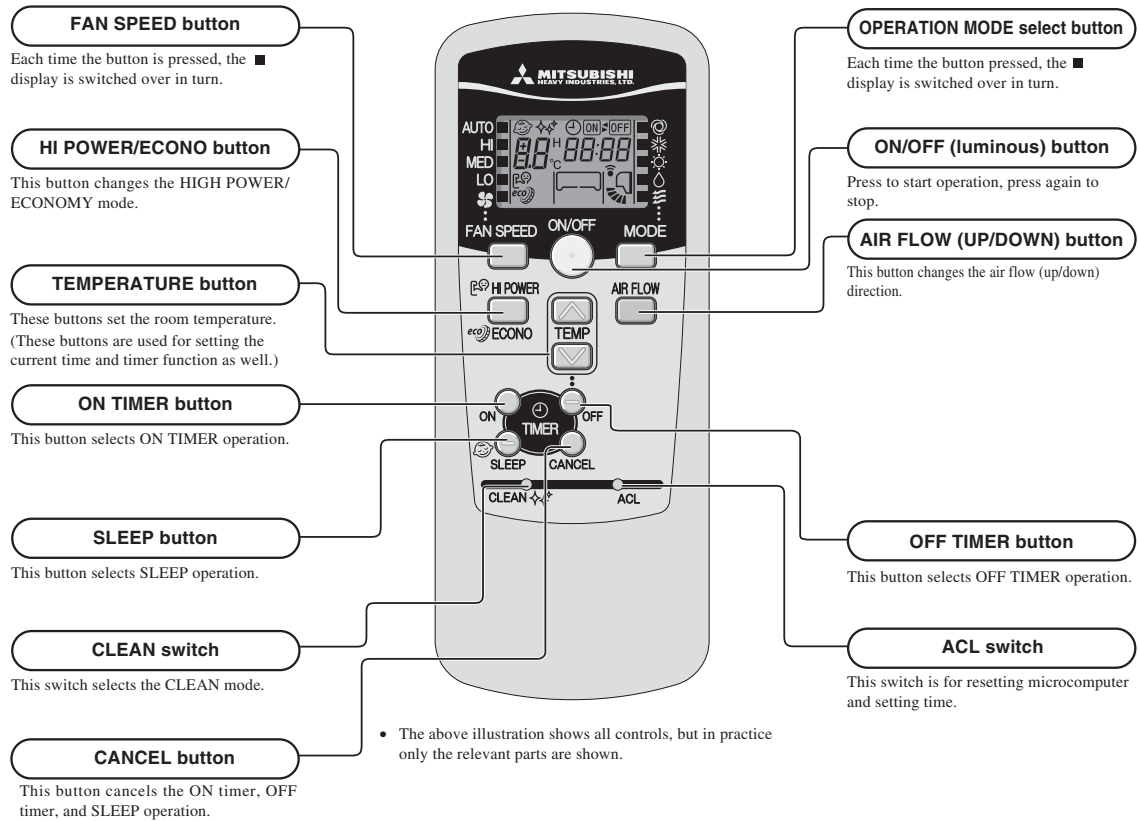

Unit display section

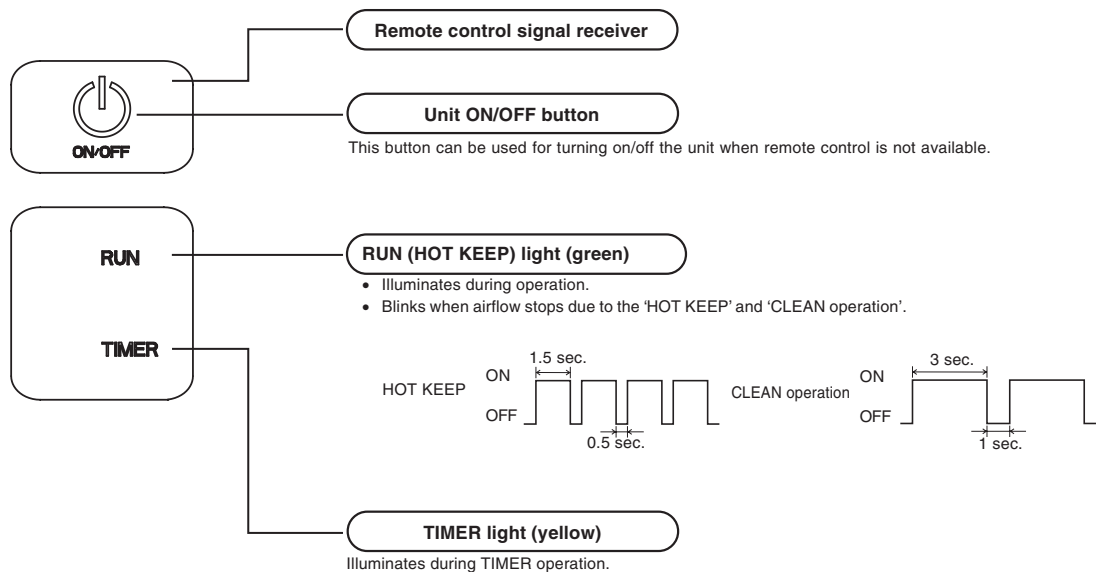

(2) Unit ON/OFF button

When the remote control batteries become weak, or if the remote control is lost or malfunctioning, this button may be used to turn the unit on and off.

(a) Operation

Push the button once to place the unit in the automatic mode. Push it once more to turn the unit off.

(b) Details of operation

The unit will go into the automatic mode in which it automatically determines, from room temperature (as detected by sensor), whether to go into the cooling, thermal dry or heating modes.

Function	Room temperature setting	Fan speed	Flap	Timer switch
Operation mode				
COOL	About 24°C	Auto	Auto	Continuous
DRY	About 24°C			
HEAT	About 26°C			

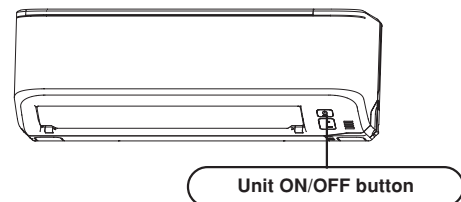

(3) Auto restart function

(a) Auto restart function records the operational status of the air-conditioner immediately prior to be switched off by a power cut, and then automatically resumes operations after the power has been restored.

(b) The following settings will be cancelled:

- (i) Timer settings
- (ii) HIGH POWER operations

- Notes
- (1) Auto restart function is set at on when the air-conditioner is shipped from the factory. Consult with your dealer if this function needs to be switched off.
 - (2) When power failure occurs, the timer setting is cancelled. Once power is resumed, reset the timer.
 - (3) If the jumper wire (J1) "AUTO RESTART" is cut, auto restart is disabled. (See the diagram at right)

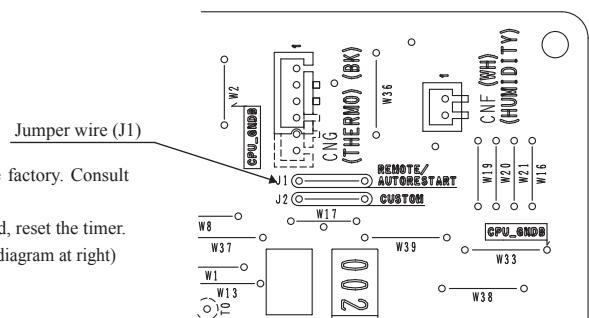

(4) Custom cord switching procedure

If two wireless remote control are installed in one room, in order to prevent wrong operation due to mixed signals, please modify the printed circuit board in the indoor unit's control box and the remote control using the following procedure. Be sure to modify both boards. If only one board is modified, receiving (and operation) cannot be done.

(a) Modifying the indoor unit's printed circuit board

Take out the printed circuit board from the control box and cut off jumper wire (J2) using wire cutters.

After cutting of the jumper wire, take measures to prevent contact with the other the lead wires, etc.

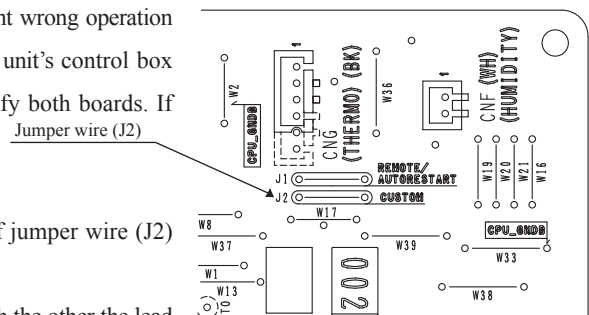

(b) Modifying the wireless remote control

- (i) Remove the battery.
- (ii) Cut the jumper wire shown in the figure at right.

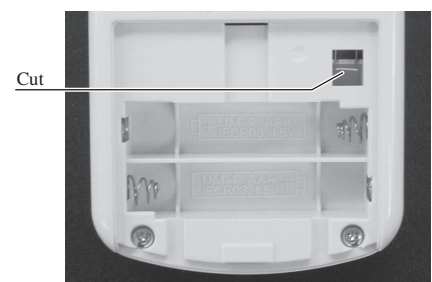

(5) High power operation

Pressing the HI POWER/ECONO button intensifies the operating power and initiates powerful cooling and heating operation for 15 minutes continuously. The remote control displays and the FAN SPEED display disappears.

- (a) During the HIGH POWER operation, the room temperature is not controlled. When it causes an excessive cooling and heating, press the HI POWER/ECONO button again to cancel the HIGH POWER operation.
- (b) HIGH POWER operation is not available during the DRY and the program timer operations.
- (c) When HIGH POWER operation is set after ON TIMER operation, HIGH POWER operation will start from the set time.
- (d) When the following operation are set, HIGH POWER operation will be canceled.
 - ① When the HI POWER/ECONO button is pressed again.
 - ② When the operation mode is changed.
 - ③ When it has been 15 minutes since HIGH POWER operation has started.
- (e) Not operable while the air conditioner is OFF.

(6) Economy operation

Pressing the HI POWER/ECONO button initiate a soft operation with the power suppressed in order to avoid an excessive cooling or heating. The unit operate 1.5°C higher than the setting temperature during cooling or 2.5°C lower than that during heating. The remote control displays ECONO mark and the FAN SPEED display disappears.

- (a) It will go into ECONOMY operation at the next time the air conditioner runs in the following cases.
 - ① When the air-conditioner is stopped by ON/OFF button during ECONOMY operation.
 - ② When the air-conditioner is stopped in SLEEP or OFF TIMER operation during ECONOMY operation.
 - ③ When the operation is retrieved from CLEAN operation.
- (b) When the following operation are set, ECONOMY operation will be canceled.
 - ① When the HI POWER/ECONO button is pressed again.
 - ② When the operation mode is changed DRY to FAN.
- (c) Not operable while the air-conditioner is OFF.
- (d) The setting temperature is adjusted according to the following table.

Item \ Mode	Cooling	Heating
Temperature adjustment	① +0.5	① -1.0
	② +1.0	② -2.0
	③ +1.5	③ -2.5

- ① at the start of operation.
- ② one hour after the start of operation.
- ③ two hours after the start of operation.

(7) Flap control

Control the flap by AIRFLOW ◆ (UP/DOWN) button on the wireless remote control.

(a) Flap

Each time when you press the AIRFLOW ◆ (UP/DOWN) button the mode changes as follows.

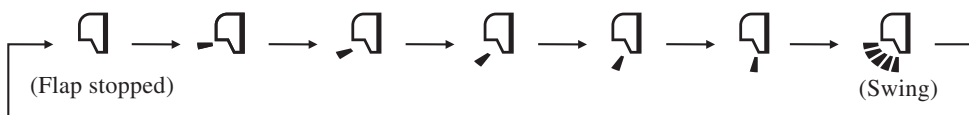

• Angle of flap from horizontal

Remote control display					
COOL , DRY	Approx. 15°	Approx. 25°	Approx. 35°	Approx. 45°	Approx. 59°
HEAT	Approx. 25°	Approx. 35°	Approx. 50°	Approx. 59°	Approx. 65°

(b) Swing

Flap moves in upward and downward directions continuously.

- ◆ In HEAT operation
- ◆ In COOL, DRY operation

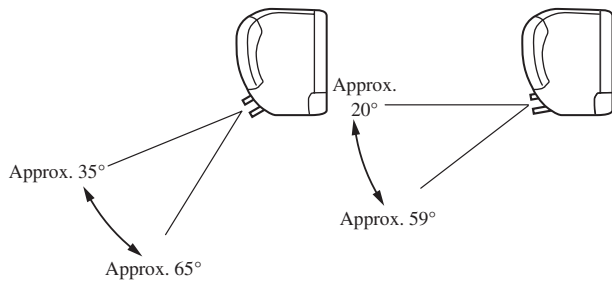

(c) Memory flap

When you press the AIRFLOW (UP/DOWN) button once while the flap is operating, it stops swinging at an angle. Since this angle is memorized in the microcomputer, the flap will automatically be set at this angle when the next operation is started.

(d) When not operating

The flap returns to the position of air flow directly below, when operation has stopped.

(8) Timer operation

(a) Comfortable timer setting (ON timer)

If the timer is set at ON when the operation select switch is set at the cooling or heating, or the cooling or heating in auto mode operation is selected, the comfortable timer starts and determines the starting time of next operation based on the initial value of 15 minutes and the relationship between the room temperature at the setting time (temperature of room temperature sensor) and the setting temperature.

(b) Sleep timer operation

Pressing the SLEEP button causes the temperature to be controlled with respect to the set temperature.

(c) OFF timer operation

The Off timer can be set at a specific time (in 10-minute units) within a 24-hour period.

(9) Outline of heating operation

(a) Operation of major functional components in heating mode

	Heating			
	Thermostat ON	Thermostat OFF	Defrost	Failure
Compressor	ON	OFF	OFF	OFF
Indoor fan motor	ON	ON(HOT KEEP)	OFF	OFF
Outdoor fan motor	ON	OFF (few minutes ON)	OFF	OFF
4-way valve	ON	ON	OFF	OFF (3 minutes ON)

(b) Details of control at each operation mode (pattern)

(i) Fuzzy operation

Deviation between the room temperature setting correction temperature and the suction air temperature is calculated in accordance with the fuzzy rule, and used for control of the air capacity and the compressor command speed.

Model	SRK25ZMP-S	SRK35ZMP-S	SRK45ZMP-S
Fan speed			
AUTO	20~115rps		12~110rps
HI	20~115rps		12~110rps
MED	20~72rps	20~84rps	12~78rps
LO	20~54rps	20~62rps	12~50rps

When the defrosting, protection device, etc. is actuated, operation is performed in the corresponding mode.

(ii) Hot keep operation

If the hot keep operation is selected during the heating operation, the indoor blower is controlled based on the temperature of the indoor heat exchanger (Th2) to prevent blowing of cool wind.

However, if the fan speed setting is HI and room temperature is 19°C or higher, this control is not executed.

(c) Defrosting operation

(i) Starting conditions (Defrosting operation can be started only when all of the following conditions are met.)

- 1) After start of heating operation
When it elapsed 35 (model SRK35 : 45) minutes. (Accumulated compressor operation time)
- 2) After end of defrosting operation
When it elapsed 35 (model SRK35 : 45) minutes. (Accumulated compressor operation time)
- 3) Outdoor heat exchanger sensor (TH1) temperature
When the temperature has been below -5°C for 3 minutes continuously.
- 4) The difference between the outdoor air sensor temperature and the outdoor heat exchanger sensor temperature
 - The outdoor air temperature $\geq 0^{\circ}\text{C}$ (model SRK45 : $\geq -2^{\circ}\text{C}$) : 7°C (model SRK45 : 10°C) or higher
 - $-15^{\circ}\text{C} \leq$ The outdoor air temperature $< 0^{\circ}\text{C}$ (model SRK45 : $\geq -2^{\circ}\text{C}$) : $2/15 \times$ The outdoor air temperature + 7°C (model SRK45 : $+10^{\circ}\text{C}$) or higher
 - The outdoor air temperature $< -15^{\circ}\text{C}$: -5°C or higher

Models SRK25, 35ZMP-S

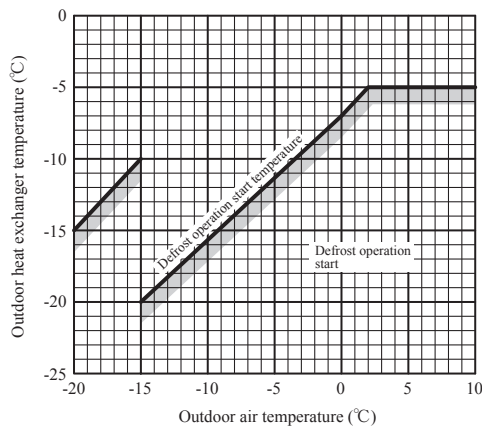

Model SRK45ZMP-S

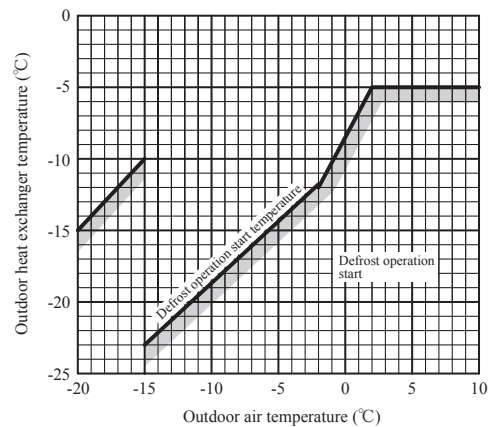

5) During continuous compressor operation

In addition, when the speed command from the indoor control of the indoor unit during heating operation has counted 0 rps 10 times or more and all conditions of 1), 2), 3) and 5) above and the outdoor air temperature is 3°C or less are satisfied (note that when the temperature for outdoor heat exchanger sensor (TH1) is -5°C or less: 62 rps or more, -4°C or less: less than 62 rps), defrost operation is started.

(ii) Ending conditions (Operation returns to the heating cycle when either one of the following is met.)

- 1) Outdoor heat exchanger sensor (TH1) temperature: 13°C or higher
- 2) Continued operation time of defrosting → For more than 16 minutes and 50 seconds (model SRK45 : 17 minutes).

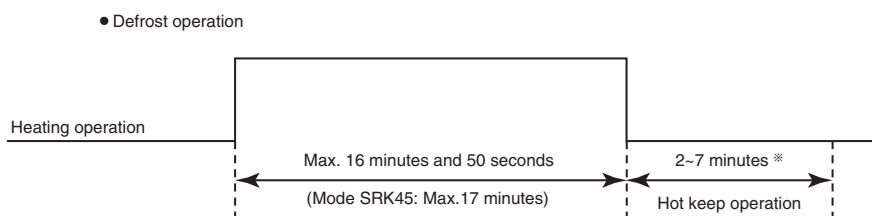

※Depends on an operation condition, the time can be longer than 7 minutes.

(10) Outline of cooling operation

(a) Operation of major functional components in Cooling mode

	Cooling		
	Thermostat ON	Thermostat OFF	Failure
Compressor	ON	OFF	OFF
Indoor fan motor	ON	ON	ON
Outdoor fan motor	ON	OFF (few minutes ON)	OFF (few minutes ON)
4-way valve	OFF	OFF	OFF

(b) Detail of control in each mode (Pattern)

(i) Fuzzy operation

During the fuzzy operation, the air flow and the compressor command speed are controlled by calculating the difference between the room temperature setting correction temperature and the suction air temperature.

Model	SRK25ZMP-S	SRK35ZMP-S	SRK45ZMP-S
Fan speed			
AUTO	20~74rps	20~98rps	12~96rps
HI	20~74rps	20~98rps	12~96rps
MED	20~52rps	20~74rps	12~62rps
LO	20~38rps	20~46rps	12~38rps

(11) Outline of automatic operation

(a) Determination of operation mode

The unit checks the indoor air temperature and the outdoor air temperature, determines the operation mode, and then begins in the automatic operation.

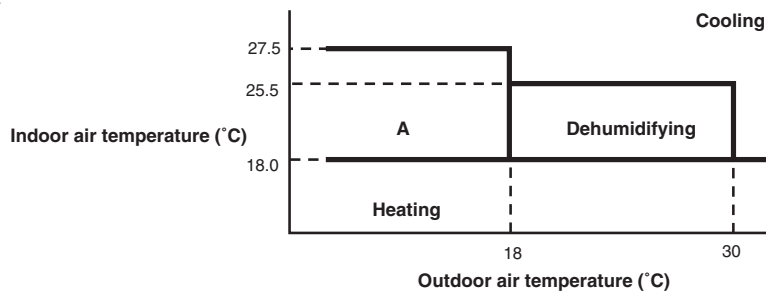

(b) The unit checks the temperature every hour after the start of operation and, if the result of check is not same as the previous operation mode, changes the operation mode.

- (i) If the setting temperature is changed with the remote control, the operation mode is judged immediately.
- (ii) When both the indoor and the outdoor air temperatures are in the range “A”, cooling or heating is switched depending on the difference between the setting temperature and the indoor air temperature.
- (iii) When the operation mode has been judged following the change of setting temperature with the remote control, the hourly judgment of operation mode is cancelled.

(c) When the unit is started again within one hour after the stop of automatic operation or when the automatic operation is selected during heating, cooling or dehumidifying operation, the unit is operated in the previous operation mode.

(d) Setting temperature can be adjusted within the following range. There is the relationship as shown below between the signals of the wireless remote control and the setting temperature.

		Signals of wireless remote control (Display)												
		-6	-5	-4	-3	-2	-1	±0	+1	+2	+3	+4	+5	+6
Setting temperature	Cooling	18	19	20	21	22	23	24	25	26	27	28	29	30
	Dehumidifying	19	20	21	22	23	24	25	26	27	28	29	30	31
	Heating	20	21	22	23	24	25	26	27	28	29	30	31	32

(e) When the unit is operated automatically with the wired remote control connected, the cooling operation is controlled according to the display temperatures while the setting temperature is compensated by +1°C during dehumidifying or by +2°C during heating.

(12) Protection control function

(a) Dew prevention control [Cooling]:Prevents dewing on the indoor unit.

(i) Operating conditions:When the following conditions have been met for more than 30 minutes after starting operation

- 1) Compressor's command speed is 32 rps or higher. (SRK25, 35 only)
- 2) Detected value of humidity is 68% or higher.

(ii) Contents of operation

- 1) Air capacity control

Item		Model	SRK25, 35ZMP-S	SRK45ZMP-S
LO	Upper limit of compressor's command speed		RangeA: 45rps, RangeB: 45rps	RangeA: 50rps, RangeB: 34rps
	Indoor fan		4th speed	
AUTO,HI,MED	Upper limit of compressor's command speed		RangeA: 45rps, RangeB: 45rps	RangeA: 50rps, RangeB: 34rps
	Indoor fan		Adaptable to compressor's command speed (Lower limit 4th speed)	

Note (1) Ranges A and B are as shown below.

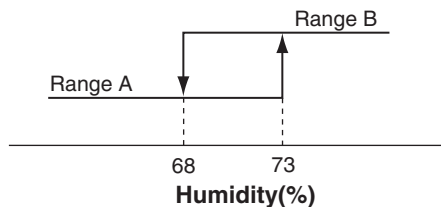

2) When this control has continued for more than 30 minutes continuously,the following wind direction control is performed.

- a) When the vertical wind direction is set at other than the vertical swing,the flaps change to the horizontal position.
- b) When the horizontal wind direction is set at other than the horizontal swing,the louver changes to the vertical position.

(iii) Resetting condition:When any of followings is met

- 1) Compressor's command speed is less than 32 rps. (SRK25, 35 only)
- 2) Detected value of humidity is less than 63%.

(b) Frost prevention control (During cooling or dehumidifying)

(i) Operating conditions

- 1) Indoor heat exchanger temperature (Th2) is lower than 5°C.
- 2) 5 minutes after reaching the compressor command speed except 0 rps.

(ii) Detail of anti-frost operation

Item	Indoor heat exchanger temperature	
	5°C or lower	2.5°C or lower
Lower limit of compressor command speed	22 rps	0 rps
Indoor fan	Depends on operation mode	Protects the fan tap just before frost prevention control
Outdoor fan	Depends on command speed	Depends on stop mode
4-way valve	OFF	

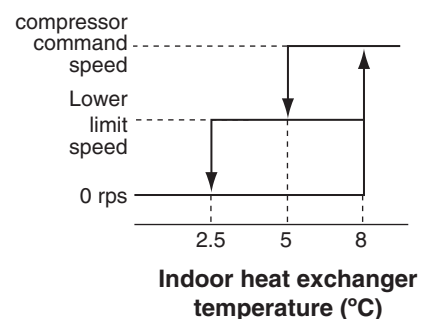

- Notes
- (1) When the indoor heat exchanger temperature is in the range of 2.5~5°C, the speed is reduced by 4 rps at each 20 seconds.
 - (2) When the temperature is lower than 2.5°C, the compressor is stopped.
 - (3) When the indoor heat exchanger temperature is in the range of 5~8°C, the compressor command speed is been maintained.

(iii) Reset conditions: When either of the following condition is satisfied.

- 1) The indoor heat exchanger temperature (Th2) is 8°C or higher.
- 2) The compressor command speed is 0 rps.

(c) Cooling overload protective control

(i) Operating conditions: When the outdoor air temperature (TH2) has become continuously for 30 seconds at 41°C or more, or 47°C or more (Model SRK45: 41°C or more) with the compressor running, the lower limit speed of compressor is brought up.

Model	SRK25, 35ZMP-S		SRK45ZMP-S
Item			
Outdoor air temperature	41°C or more	47°C or more	41°C or more
Lower limit speed	30 rps	40 rps	30 rps

(ii) Detail of operation

- 1) The outdoor fan is stepped up by 3 speed step. (Upper limit 8th speed.)
- 2) The lower limit of compressor command speed is set to 30 or 40 (model SRK45 : 30) rps and even if the calculated result becomes lower than that after fuzzy calculation, the speed is kept to 30 or 40 (model SRK45 : 30) rps. However, when the thermo OFF, the speed is reduced to 0 rps.

(iii) Reset conditions: When either of the following condition is satisfied.

- 1) The outdoor air temperature is lower than 40°C.
- 2) The compressor command speed is 0 rps.

(d) Cooling high pressure control

(i) Purpose: Prevents anomalous high pressure operation during cooling.

(ii) Detector: Outdoor heat exchanger sensor (TH1)

(iii) Detail of operation:

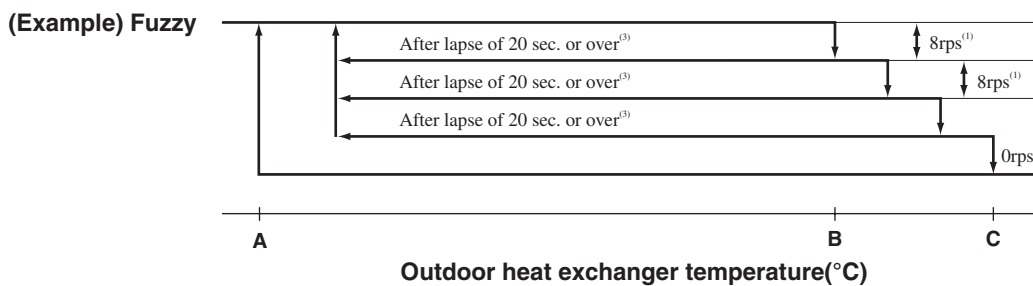

- Notes
- (1) When the outdoor heat exchanger temperature is in the range of B~C °C, the speed is reduced by 8 rps at each 20 seconds.
 - (2) When the temperature is C °C or higher, the compressor is stopped.
 - (3) When the outdoor heat exchanger temperature is in the range of A~B °C, if the compressor command speed is been maintained and the operation has continued for more than 20 seconds at the same speed, it returns to the normal cooling operation.

• Temperature list

Model	A	B	C
Outdoor air temperature ≥ 32 °C	50	52	56
Outdoor air temperature < 32 °C	42	44	50

(e) Cooling low outdoor air temperature protective control

(i) Operating conditions: When the outdoor air temperature (TH2) is 22°C or lower continues for 20 seconds while the compressor command speed is other than 0 rps.

(ii) Detail of operation:

- 1) The lower limit of the compressor command speed is set to 50[44] <44> (30) rps and even if the speed becomes lower than 50[44] <44> (30) rps, the speed is kept to 50[44] <44> (30) rps. However, when the thermo OFF, the speed is reduced to 0 rps.
- 2) The upper limit of the compressor command speed is set to 50 <50> (60) rps and even if the calculated result becomes higher than that after fuzzy calculation, the speed is kept to 50 <50> (60) rps.

- Notes
- (1) Values in < > are for outdoor air temperature is A°C or B°C
 - (2) Values in () are for outdoor air temperature is C°C or D°C
 - (3) Values in [] are for the model SRK45.

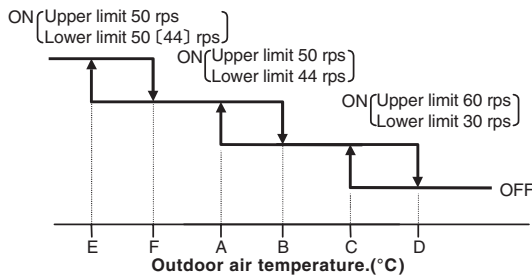

● Values of A, B, C, D, E, F (Models SRK25, 35)

	Outdoor air temperature (°C)					
	E	F	A	B	C	D
First time	-8	-5	0	3	22	25
After the second times	-2	1	5	8	25	28

● Values of A, B, C, D, E, F (Model SRK45)

	Outdoor air temperature (°C)					
	E	F	A	B	C	D
First time	0	2	9	11	22	25
After the second times	5	7	16	19	25	28

(iii) **Reset conditions:** When either of the following condition is satisfied

- 1) The outdoor air temperature (TH2) is D °C or higher.
- 2) The compressor command speed is 0 rps.

(f) Heating high pressure control

- (i) **Purpose:** Prevents anomalous high pressure operation during heating.
- (ii) **Detector:** Indoor heat exchanger sensor (Th2)
- (iii) **Detail of operation:**

(Example) Fuzzy

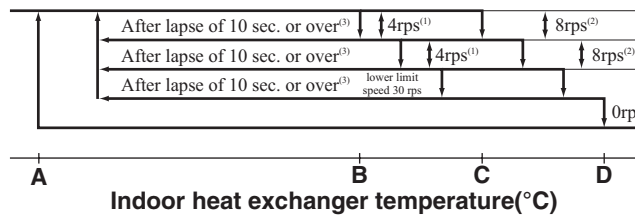

- Notes
- (1) When the indoor heat exchanger temperature is in the range of B~C °C, the speed is reduced by 4 rps at each 10 seconds.
 - (2) When the indoor heat exchanger temperature is in the range of C~D °C, the speed is reduced by 8 rps at each 10 seconds. When the temperature is D °C or higher continues for 1 minute, the compressor is stopped.
 - (3) When the indoor heat exchanger temperature is in the range of A~B °C, if the compressor command speed is been maintained and the operation has continued for more than 10 seconds at the same speed, it returns to the normal heating operation.
 - (4) Indoor blower retains the fan tap when it enters in the high pressure control. Outdoor blower is operated in accordance with the speed.

● **Temperature list**

Models SRK25, 35

Unit : °C

	A	B	C	D
RPSmin < 50	48	52	54	55
50 ≤ RPSmin < 91	48.5	54.5	58	61
91 ≤ RPSmin < 97	48.5	54.5 ~ 51.5	58	61
97 ≤ RPSmin < 100	48.5	51.5 ~ 50	58 ~ 56	61
100 ≤ RPSmin < 115	48.5 ~ 40.1	50 ~ 42	56 ~ 47.3	61
115 ≤ RPSmin	40.1	42	47.3	61

Model SRK45

Unit : °C

	A	B	C	D
RPSmin < 80	46	54	56	58~62
80 ≤ RPSmin < 102	46~33.5	54~38.5	56~39.5	58~51
102 ≤ RPSmin < 120	33.5	38.5	39.5	51
120 ≤ RPSmin	33.5	38.5	39.5	51

Note (1) RPSmin: The lower one between the compressor command speed

(g) Heating overload protective control

(i) Indoor unit side

- 1) **Operating conditions :** When the outdoor air temperature (TH2) is 17°C or higher continues for 30 seconds while the compressor command speed other than 0 rps.
- 2) **Detail of operation :** The indoor fan is stepped up by 1 speed step. (Upper limit 8th speed)
- 3) **Reset conditions :** The outdoor air temperature (TH2) is lower than 16°C.

(ii) Outdoor unit side

- 1) **Operating conditions :** When the outdoor air temperature (TH2) is 17 or 22 (14 or 20)°C or higher continues for 30 seconds while the compressor command speed other than 0 rps.
- 2) **Detail of operation:** Upper and lower limits of compressor speed and the outdoor unit fan speed are restricted.

Models SRK25, 35

	Compressor command speed (rps)		Outdoor fan speed
	Lower limit	Upper limit	
ON1	–	–	2nd speed
ON2	40	60	1st speed

Model SRK45

	Compressor command speed (rps)		Outdoor fan speed
	Lower limit	Upper limit	
ON1	30	78	(1)
ON2	30	51	2nd speed

Note (1) Outdoor fan speed
 Lowe limit : 4th speed
 Upper limit : 7th speed

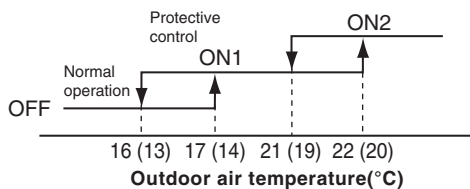

- 3) **Reset conditions:** When the outdoor air temperature drops below 16 (13)°C.
 Note (1) Values in () are for the model SRK45.

(h) Heating low outdoor temperature protective control

(i) Protective control I

- 1) **Operating conditions:** When the outdoor air temperature (TH2) is lower than 2 (4)°C or higher continues for 30 seconds while the compressor command speed is other than 0 rps.
- 2) **Detail of operation:** The lower limit compressor command speed is changed as shown in the figure below.

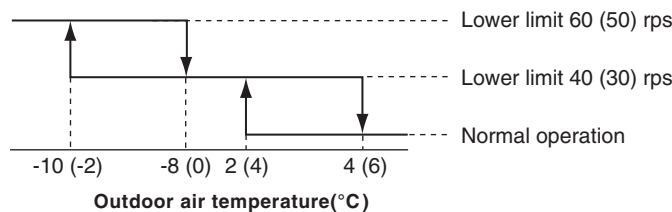

- 3) **Reset conditions:** When either of the following condition is satisfied.
 - a) The outdoor air temperature (TH2) becomes 4 (6)°C.
 - b) The compressor command speed is 0 rps.
 Note (1) Values in () are for the model SRK45.

(ii) Protective control II (Models SRK25, 35 only)

- 1) **Operating conditions:** When the outdoor heat exchanger sensor (TH1) is -10°C or lower continuously for 10 minutes while the compressor command speed is other than 0 rps.
- 2) **Detail of operation:** Upper limit of compressor command speed is 115rps.
- 3) **Reset conditions:** When the either of the following condition is satisfied.
 - a) When the outdoor heat exchanger sensor (TH1) becomes -8°C or higher.
 - b) When the compressor command speed is 0 rps.

(i) Compressor overheat protection

(i) Purpose: It is designed to prevent deterioration of oil, burnout of motor coil and other trouble resulting from the compressor overheat.

(ii) Detail of operation

1) Speeds are controlled with temperature detected by the sensor mounted on the discharge pipe.

(Example) Fuzzy

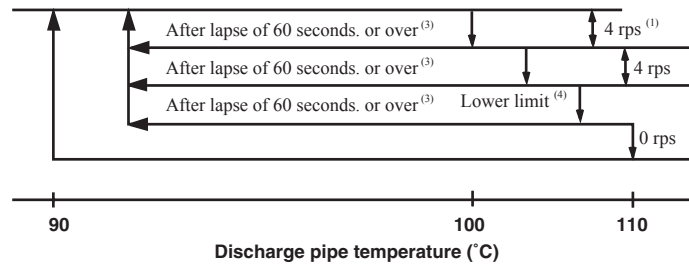

- Notes (1) When the discharge pipe temperature is in the range of 100 to 110 °C, the speed is reduced by 4 rps.
 (2) When the discharge pipe temperature is raised and continues operation for 20 seconds without changing, then the speed is reduced again by 4 rps.
 (3) If the discharge pipe temperature is in the range of 90~100°C even when the compressor command speed is maintained for 60 second when the temperature is in the range of 90~100°C, the speed is raised by 1 rps and kept at that speed for 60 second. This process is repeated until the command speed is reached.
 (4) Lower limit speed

	Cooling	Heating
Models SRK25, 35, 45	20 rps	30 rps

2) If the temperature of 110°C is detected by the sensor on the discharge pipe, then the compressor will stop immediately. When the discharge pipe temperature drops and the time delay of 3 minutes is over, the unit starts again within 1 hour but there is no start at the third time.

(j) Current safe

(i) Purpose: Current is controlled not to exceed the upper limit of the setting operation current.

(ii) Detail of operation: Input current to the converter is monitored with the current sensor fixed on the printed circuit board of the outdoor unit and, if the operation current value reaches the limiting current value, the compressor command speed is reduced.

If the mechanism is actuated when the speed of compressor command is less than 30 rps, the compressor is stopped immediately. Operation starts again after a delay time of 3 minutes.

(k) Current cut

(i) Purpose: Inverter is protected from overcurrent.

(ii) Detail of operation: Output current from the converter is monitored with a shunt resistor and, if the current exceeds the setting value, the compressor is stopped immediately. Operation starts again after a delay time of 3 minutes.

(l) Outdoor unit failure

This is a function for determining when there is trouble with the outdoor unit during air conditioning.

The compressor is stopped if any one of the following in item (i), (ii) is satisfied. Once the unit is stopped by this function, it is not restarted.

- (i) When the input current is measured at 1 A or less for 3 continuous minutes or more.
- (ii) If the compressor command sends a 0 rps signal to the indoor unit 3 times or more within 20 minutes of the power being turned on.

(m) Indoor fan motor protection

When the air conditioner is operating and the indoor fan motor is turned ON, if the indoor fan motor has operated at 300 min⁻¹ or under for more than 30 seconds, the unit enters first in the stop mode and then stops the entire system.

(n) Serial signal transmission error protection

- (i) Purpose:** Prevents malfunction resulting from error on the indoor ↔ outdoor signals.
- (ii) Detail of operation:** If the compressor is operating and a serial signal cannot be received from the indoor control with outdoor control having serial signals continues for 7 minute and 35 seconds, the compressor is stopped.
After the compressor has been stopped, it will be restarted after the compressor start delay if a serial signal can be received again from the indoor control.

(o) Rotor lock

If the motor for the compressor does not turn after it has been started, it is determined that a compressor lock has occurred and the compressor is stopped.

(p) Outdoor fan motor protection

If the outdoor fan motor has operated at 75 rpm or under for more than 30 seconds, the compressor and fan motor are stopped.

(q) Outdoor fan control at low outdoor temperature

(i) Cooling

- 1) Operating conditions:** When the outdoor air temperature (TH2) is 22°C or lower continues for 30 seconds while the compressor command speed is other than 0 rps.
- 2) Detail of operation:** After the outdoor fan operates at A speed for 60 seconds; the corresponding outdoor heat exchanger temperature shall implement the following controls.

● Value of A

	Outdoor fan
Outdoor temperature > 10°C	2nd speed
Outdoor temperature ≤ 10°C	1st speed

- a) Outdoor heat exchanger temperature (TH1) ≤ 21°C
After the outdoor fan speed drops (down) to 1 speed for 60 seconds; if the outdoor heat exchanger temperature is lower than 21°C, gradually reduce the outdoor fan speed by 1 speed. (Lower limit 1st speed)
 - b) 21°C < Outdoor heat exchanger temperature (TH1) ≤ 38°C
After the outdoor fan speed maintains at A speed for 20 seconds; if the outdoor heat exchanger temperature is 21°C~38°C, maintain outdoor fan speed.
 - c) Outdoor heat exchanger temperature (TH1) > 38°C
After the outdoor fan speed rises (up) to 1 speed for 60 seconds; if the outdoor heat exchanger temperature is higher than 38°C, gradually increase outdoor fan speed by 1 speed. (Upper limit 3rd speed)
- 3) Reset conditions:** When either of the following conditions is satisfied
- a) The outdoor air temperature (TH2) is 25°C or higher.
 - b) The compressor command speed is 0 rps.
- (ii) Heating**
- 1) Operating conditions:** When the outdoor air temperature (TH2) is 4°C (model SRK45:0°C) or lower continues for 30 seconds while the compressor command speed is other than 0 rps.
 - 2) Detail of operation:** The outdoor fan is stepped up by 2 speed step at each 20 seconds. (Upper limit 8th speed)
 - 3) Reset conditions:** When either of the following conditions is satisfied
 - a) The outdoor air temperature (TH2) is 6°C (model SRK45:2°C) or higher.
 - b) The compressor command speed is 0 rps.

(r) Refrigeration cycle system protection

(i) Starting conditions

- 1) When 5 minutes have elapsed after the compressor ON or the completion of the defrost control
- 2) Other than the defrost control
- 3) When, after meeting the conditions of 1) and 2) above, the compressor speed, indoor air temperature (Th1) and indoor heat exchanger temperature (Th2) have met the conditions in the following table for 10 (SRK45:5) minutes:

Operation mode	Compressor speed (N)	Indoor air temperature (Th1)	Indoor air temperature (Th1)/ Indoor heat exchanger temperature (Th2)
Cooling	$50 \leq N$	$10 \leq Th1 \leq 40$	$Th1 - 4 < Th2$
Heating(1)	$50 \leq N$	$0 \leq Th1 \leq 40$	$Th2 < Th1 + 6$

Note (1) Except that the fan speed is HI in heating operation.

(ii) Contents of control

- 1) When the conditions of (i) above are met, the compressor stops.
- 2) Error stop occurs when the compressor has stopped 3 times within 60 minutes.

(iii) Resetting condition

When the compressor has been turned OFF

10. MAINTENANCE DATA

(1) Cautions

- (a) If you are disassembling and checking an air conditioner, be sure to turn off the power before beginning. When working on indoor units, let the unit sit for about 1 minute after turning off the power before you begin work. When working on an outdoor unit, there may be an electrical charge applied to the main circuit (electrolytic condenser), so begin work only after discharging this electrical charge (to DC 10 V or lower).
- (b) When taking out printed circuit boards, be sure to do so without exerting force on the circuit boards or package components.
- (c) When disconnecting and connecting connectors, take hold of the connector housing and do not pull on the lead wires.

(2) Items to check before troubleshooting

- (a) Have you thoroughly investigated the details of the trouble which the customer is complaining about?
- (b) Is the air conditioner running? Is it displaying any self-diagnosis information?
- (c) Is a power supply with the correct voltage connected?
- (d) Are the control lines connecting the indoor and outdoor units wired correctly and connected securely?
- (e) Is the outdoor unit's service valve open?

(3) Troubleshooting procedure (If the air conditioner does not run at all)

If the air conditioner does not run at all, diagnose the trouble using the following troubleshooting procedure. If the air conditioner is running but breaks down, proceed to troubleshooting step (4).

Important When all the following conditions are met, we say that the air conditioner will not run at all.

- (a) The RUN light does not light up.
- (b) The flaps do not open.
- (c) The indoor unit fan motors do not run.
- (d) The self-diagnosis display does not function.

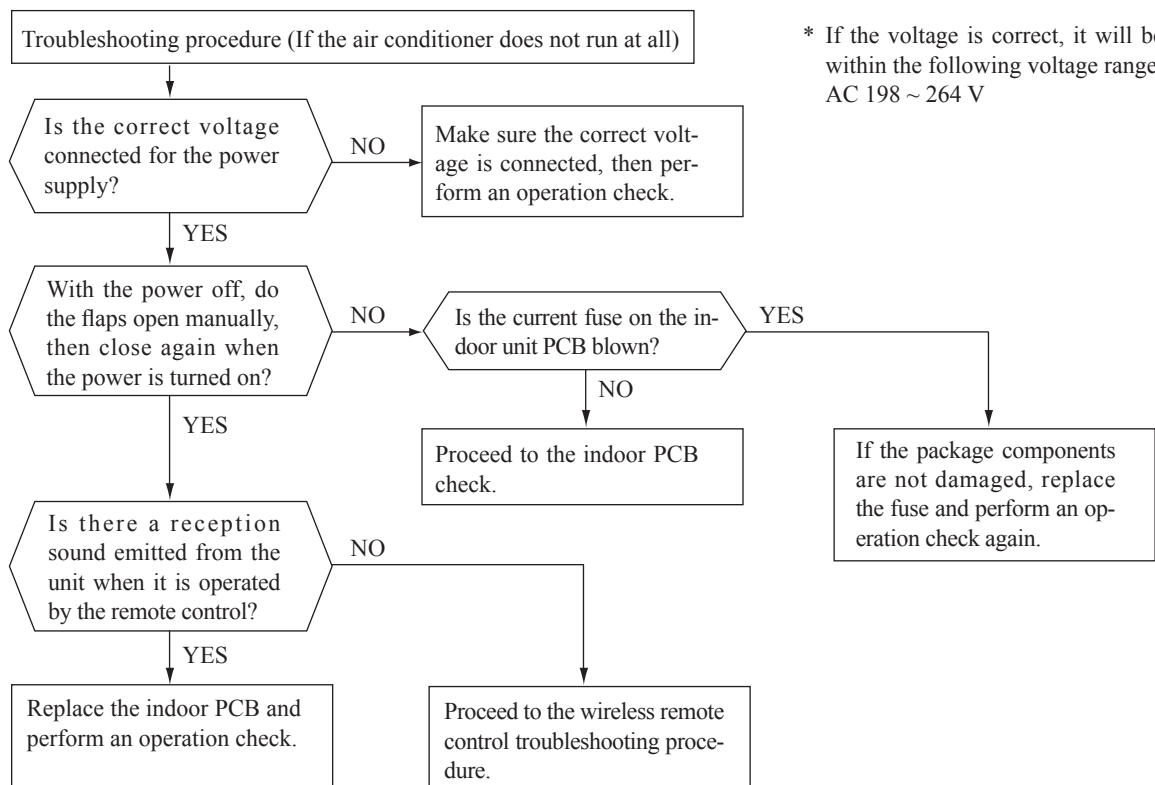

(4) Troubleshooting procedure (If the air conditioner runs)

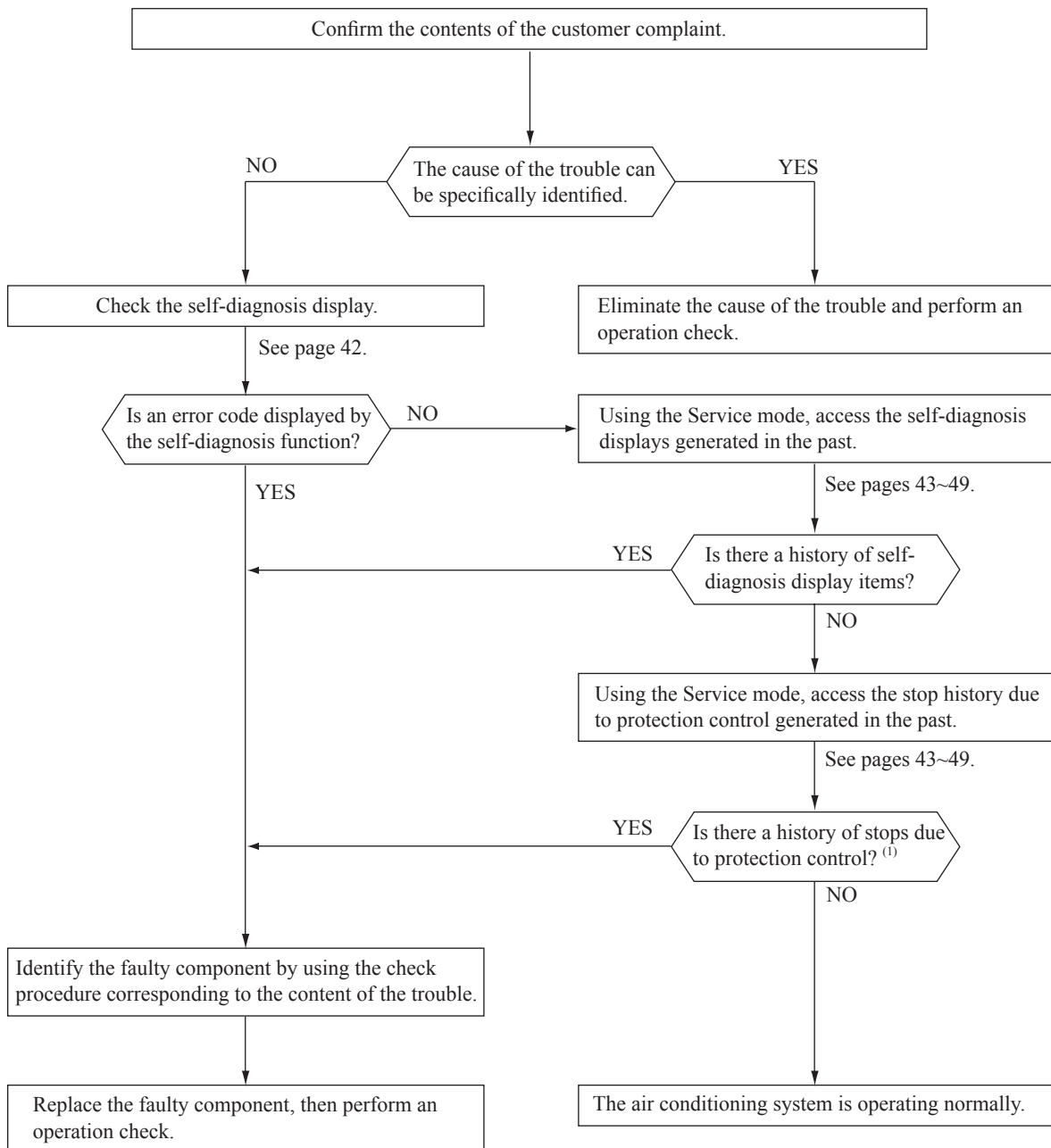

Note (1) Even in cases where only intermittent stop data are generated, the air conditioning system is normal. However, if the same protective operation recurs repeatedly (3 or more times), it will lead to customer complaints. Judge the conditions in comparison with the contents of the complaints.

(5) Self-diagnosis table

When this air conditioner performs an emergency stop, the reason why the emergency stop occurred is displayed by the flashing of display lights. If the air conditioner is operated using the remote control 3 minutes or more after the emergency stop, the trouble display stops and the air conditioner resumes operation. ⁽¹⁾

Indoor unit display section		Description of trouble	Cause	Display (flashing) condition
RUN light	TIMER light			
1 - time flash	ON	Indoor heat exchanger sensor error	<ul style="list-style-type: none"> Broken heat exchanger sensor wire, poor connector connection Indoor PCB is faulty 	When a heat exchanger sensor wire disconnection is detected while operation is stopped. (If a temperature of -28°C or lower is detected for 15 seconds, it is judged that the wire is disconnected.) (Not displayed during operation.)
2 - time flash	ON	Room temperature sensor error	<ul style="list-style-type: none"> Broken room temperature sensor wire, poor connector connection Indoor PCB is faulty 	When a room temperature sensor wire disconnection is detected while operation is stopped. (If a temperature of -45°C or lower is detected for 15 seconds, it is judged that the wire is disconnected.) (Not displayed during operation.)
5 - time flash	ON	Active filter voltage error	<ul style="list-style-type: none"> Defective active filter 	When the wrong voltage connected for the power supply. When the outdoor PCB is faulty.
6 - time flash	ON	Indoor fan motor error	<ul style="list-style-type: none"> Defective fan motor, poor connector connection 	When conditions for turning the indoor unit's fan motor on exist during air conditioner operation, an indoor unit fan motor speed of 300 min ⁻¹ or lower is measured for 30 seconds or longer. (The air conditioner stops.)
7 - time flash	ON	Refrigeration cycle system protective control	<ul style="list-style-type: none"> Service valve is closed. Refrigerant is insufficient 	When refrigeration cycle system protective control operates.
Keeps flashing	1 - time flash	Outdoor air temperature sensor error	<ul style="list-style-type: none"> Broken outdoor air temp. sensor wire, poor connector connection Outdoor PCB is faulty 	-55°C or lower is detected for 5 seconds continuously 3 times within 40 minutes after initial detection of this anomalous temperature. Or -55°C or higher is detected for within 20 seconds after power ON. (The compressor is stopped.)
Keeps flashing	2 - time flash	Outdoor heat exchanger sensor error	<ul style="list-style-type: none"> Broken heat exchanger sensor wire, poor connector connection Outdoor PCB is faulty 	-55°C or lower is detected for 5 seconds continuously 3 times within 40 minutes after initial detection of this anomalous temperature. Or -55°C or higher is detected for within 20 seconds after power ON. (The compressor is stopped.)
Keeps flashing	4 - time flash	Discharge pipe sensor error	<ul style="list-style-type: none"> Broken discharge pipe sensor wire, poor connector connection Outdoor PCB is faulty 	-25°C or lower is detected for 5 seconds continuously 3 times within 40 minutes after initial detection of this anomalous temperature. (The compressor is stopped.)
ON	1 - time flash	Current cut	<ul style="list-style-type: none"> Compressor locking, open phase on compressor output, shortcircuit on power transistor, closed service valve 	The inverter output current (compressor motor current) exceeds the set value during compressor start. (The air conditioner stops.)
ON	2 - time flash	Trouble of outdoor unit	<ul style="list-style-type: none"> Broken compressor wire Compressor blockage 	When there is an emergency stop caused by trouble in the outdoor unit, or the input current value is found to be lower than the set value. (The air conditioner stops.)
ON	3 - time flash	Current safe stop	<ul style="list-style-type: none"> Overload operation Overcharge Compressor locking 	When the compressor command speed is lower than the set value and the current safe has operated. (The compressor is stopped.)
ON	4 - time flash	Power transistor error	<ul style="list-style-type: none"> Broken power transistor 	When there is an emergency stop caused by trouble in the outdoor unit, or the input current value is found to be lower than the set value continuously for 3 minutes or longer. (The compressor is stopped.)
ON	5 - time flash	Over heat of compressor	<ul style="list-style-type: none"> Gas shortage, defective discharge pipe sensor, closed service valve 	When the value of the discharge pipe sensor exceeds the set value. (The air conditioner stops.)
ON	6 - time flash	Error of signal transmission	<ul style="list-style-type: none"> Defective power supply, Broken signal wire, defective indoor/outdoor PCB 	When there is no signal between the indoor PCB and outdoor PCB for 10 seconds or longer (when the power is turned on), or when there is no signal for 7 minute 35 seconds or longer (during operation) (The compressor is stopped.)
ON	7 - time flash	Outdoor fan motor error	<ul style="list-style-type: none"> Defective fan motor, poor connector connection 	When the outdoor unit's fan motor speed continues for 30 seconds or longer at 75 rpm or lower. (3 times) (The air conditioner stops.)
ON	Keeps flashing	Cooling high pressure protection	<ul style="list-style-type: none"> Overload operation, over charge Broken outdoor heat exchange sensor wire Service valve is closed. 	When the value of the outdoor heat exchanger sensor exceeds the set value.
2 - time flash	2 - time flash	Rotor lock	<ul style="list-style-type: none"> Defective compressor Open phase on compressor Defective outdoor PCB 	If the compressor motor's magnetic pole positions cannot be correctly detected when the compressor starts. (The air conditioner stops.)

Notes (1)The air conditioner cannot be restarted using the remote control for 3 minutes after operation stops.

(6) Service mode (Trouble mode access function)

This air conditioner is capable of recording error displays and protective stops (service data) which have occurred in the past. If self-diagnosis displays cannot be confirmed, it is possible to get a grasp of the conditions at the time trouble occurred by checking these service data.

(a) Explanation of terms

Term	Explanation
Service mode	The service mode is the mode where service data are displayed by flashing of the display lights when the operations in item (b) below are performed with the indoor controller.
Service data	These are the contents of error displays and protective stops which occurred in the past in the air conditioner system. Error display contents and protective stop data from past anomalous operations of the air conditioner system are saved in the indoor unit controller's non-volatile memory (memory which is not erased when the power goes off). There are two types of data, self-diagnosis data and stop data, described below.
Self-diagnosis data	These are the data which display the reason why a stop occurred when an error display (self-diagnosis display) occurred in an indoor unit. Data are recorded for up to 5 previous occurrences. Data which are older than the 5th previous occurrence are erased. In addition, data on the temperature of each sensor (room temperature, indoor heat exchanger, outdoor heat exchanger, outdoor air temperature, discharge pipe), remote control information (operation switching, fan speed switching) are recorded when trouble occurs, so more detailed information can be checked.
Stop data	These are the data which display the reason by a stop occurred when the air conditioning system performed protective stops, etc. in the past. Even if stop data alone are generated, the system restarts automatically. (After executing the stop mode while the display is normal, the system restarts automatically.) Data for up to 10 previous occasions are stored. Data older than the 10th previous occasion are erased. (Important) In cases where transient stop data only are generated, the air conditioner system may still be normal. However, if the same protective stop occurs frequently (3 or more times), it could lead to customer complaints.

(b) Service mode display procedure

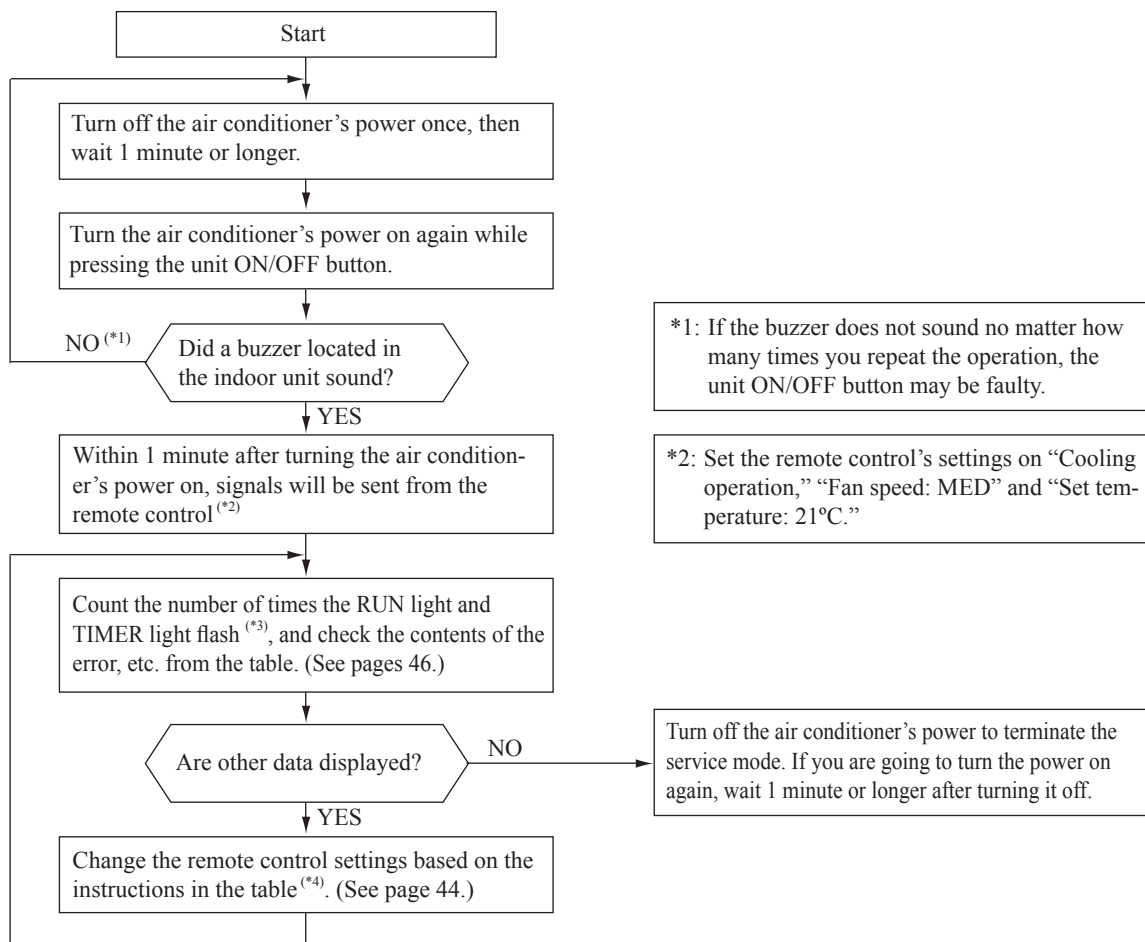

*3: To count the number of flashes in the service mode, count the number of flashes after the light lights up for 1.5 second initially (start signal). (The time that the light lights up for 1.5 second (start signal) is not counted in the number of flashes.)

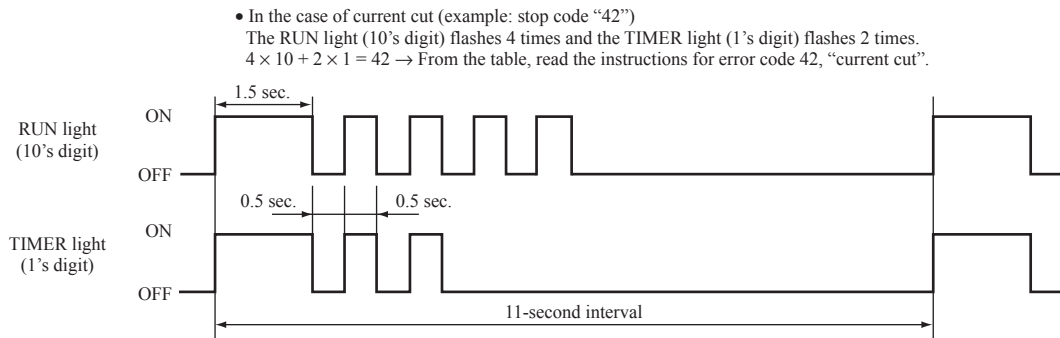

*4: When in the service mode, when the remote control settings (operation switching, fan speed switching, temperature setting) are set as shown in the following table and sent to the air conditioner unit, the unit switches to display of service data.

① **Self-diagnosis data**

What are Self- These are control data (reasons for stops, temperature at each sensor, remote control information) diagnosis Data? from the time when there were error displays (abnormal stops) in the indoor unit in the past.
 Data from up to 5 previous occasions are stored in memory. Data older than the 5th previous occasion are erased.
 The temperature setting indicates how many occasions previous to the present setting the error display data are and the operation switching and fan speed switching data show the type of data.

Remote control setting		Contents of output data
Operation switching	Fan speed switching	
Cooling	MED	Displays the reason for stopping display in the past (error code).
	HI	Displays the room temperature sensor temperature at the time the error code was displayed in the past.
	AUTO	Displays the indoor heat exchanger sensor temperature at the time the error code was displayed in the past.
Heating	LO	Displays the remote control information at the time the error code was displayed in the past.
	MED	Displays the outdoor air temperature sensor temperature at the time the error code was displayed in the past.
	HI	Displays the outdoor heat exchanger sensor temperature at the time the error code was displayed in the past.
	AUTO	Displays the discharge pipe sensor temperature at the time the error code was displayed in the past.

Remote control setting	Indicates the number of occasions previous to the present the error display data are from.
Temperature setting	
21°C	1 time previous (previous time)
22°C	2 times previous
23°C	3 times previous
24°C	4 times previous
25°C	5 times previous

(Example)

Remote control setting			Displayed data
Operation switching	Fan speed switching	Temperature setting	
Cooling	MED	21°C	Displays the reason for the stop (error code) the previous time an error was displayed.
		22°C	Displays the reason for the stop (error code) 2 times previous when an error was displayed.
		23°C	Displays the reason for the stop (error code) 3 times previous when an error was displayed.
		24°C	Displays the reason for the stop (error code) 4 times previous when an error was displayed.
		25°C	Displays the reason for the stop (error code) 5 times previous when an error was displayed.

② Stop data

Remote control setting			Displayed data
Operation switching	Fan speed switching	Temperature setting	
Cooling	LO	21°C	Displays the reason for the stop (stop code) the previous time when the air conditioner was stopped by protective stop control.
		22°C	Displays the reason for the stop (stop code) 2 times previous when the air conditioner was stopped by protective stop control.
		23°C	Displays the reason for the stop (stop code) 3 times previous when the air conditioner was stopped by protective stop control.
		24°C	Displays the reason for the stop (stop code) 4 times previous when the air conditioner was stopped by protective stop control.
		25°C	Displays the reason for the stop (stop code) 5 times previous when the air conditioner was stopped by protective stop control.
		26°C	Displays the reason for the stop (stop code) 6 times previous when the air conditioner was stopped by protective stop control.
		27°C	Displays the reason for the stop (stop code) 7 times previous when the air conditioner was stopped by protective stop control.
		28°C	Displays the reason for the stop (stop code) 8 times previous when the air conditioner was stopped by protective stop control.
		29°C	Displays the reason for the stop (stop code) 9 times previous when the air conditioner was stopped by protective stop control.
		30°C	Displays the reason for the stop (stop code) 10 times previous when the air conditioner was stopped by protective stop control.

(c) **Error code, stop code table** (Assignment of error codes and stop codes is done in common for all models.)

Number of flashes when in service mode		Stop code or Error code	Error content	Cause	Occurrence conditions	Error display	Auto recovery
RUN light (10's digit)	TIMER light (1's digit)						
OFF	OFF	0	Normal	—	—	—	—
	5 - time flash	05	Can not receive signals for 35 seconds (if communications have recovered)	Power supply is faulty. Power supply cables and signal lines are improperly wired. Indoor or outdoor PCB are faulty.	When 35 seconds passes without communications signals from either the outdoor unit or the indoor unit being detected correctly.	○	—
3 - time flash	5 - time flash	35	Cooling high pressure control	Cooling overload operation. Outdoor unit fan speed drops. Outdoor heat exchanger sensor is short circuit.	When the outdoor heat exchanger sensor's value exceeds the set value.	○ (5 times)	○
	6 - time flash	36	Compressor overheat 110°C	Refrigerant is insufficient. Discharge pipe sensor is faulty. Service valve is closed.	When the discharge pipe sensor's value exceeds the set value.	○ (2 times)	○
	7 - time flash	37	Outdoor heat exchanger sensor is abnormal	Outdoor heat exchanger sensor wire is disconnected. Connector connections are poor. Outdoor PCB is faulty.	-55°C or lower is detected for 5 seconds continuously 3 times within 40 minutes after initial detection of this anomalous temperature. Or -55°C higher is detected for 5 seconds continuously within 20 seconds after power ON.	○ (3 times)	○
	8 - time flash	38	Outdoor air temperature sensor is abnormal	Outdoor air temperature sensor wire is disconnected. Connector connections are poor. Outdoor PCB is faulty.	-55°C or lower is detected for 5 seconds continuously 3 times within 40 minutes after initial detection of this anomalous temperature. Or -55°C higher is detected for 5 seconds continuously within 20 seconds after power ON.	○ (3 times)	○
	9 - time flash	39	Discharge pipe sensor is abnormal (anomalous stop)	Discharge pipe sensor wire is disconnected. Connector connections are poor. Outdoor PCB is faulty.	-25°C or lower is detected for 5 seconds continuously 3 times within 40 minutes after initial detection of this anomalous temperature.	○ (3 times)	○
4 - time flash	2 - time flash	42	Current cut	Compressor lock. Compressor wiring short circuit. Compressor output is open phase. Outdoor PCB is faulty. Service valve is closed. Electronic expansion valve is faulty. Compressor is faulty.	Compressor start fails 42 times in succession and the reason for the final failure is current cut.	○ (2 times)	○
	7 - time flash	47	Active filter voltage error	Defective active filter	When the wrong voltage connected for the power supply. When the outdoor PCB is faulty.	○	—
	8 - time flash	48	Outdoor unit's fan motor is abnormal	Outdoor fan motor is faulty. Connector connections are poor. Outdoor PCB is faulty.	When a fan speed of 75 rpm or lower continues for 30 seconds or longer.	○ (3 times)	○
5 - time flash	1 - time flash	51	Short circuit in the power transistor (high side) Current cut circuit breakdown	Outdoor PCB is faulty. Power transistor is damaged.	When it is judged that the power transistor was damaged at the time the compressor started.	○	—
	7 - time flash	57	Refrigeration cycle system protective control	Service valve is closed. Refrigerant is insufficient.	When refrigeration cycle system protective control operates.	○ (3 times)	○
	8 - time flash	58	Current safe	Refrigerant is overcharge. Compressor lock. Overload operation.	When there is a current safe stop during operation.	—	○
	9 - time flash	59	Compressor wiring is unconnection Voltage drop Low speed protective control	Compressor wiring is disconnected. Power transistor is damaged. Power supply construction is defective. Outdoor PCB is faulty. Compressor is faulty.	When the current is 1A or less at the time the compressor started. When the power supply voltage drops during operation. When the compressor command speed is lower than 32 rps for 60 minutes.	○	○
6 - time flash	OFF	60	Rotor lock	Compressor is faulty. Compressor output is open phase. Electronic expansion valve is faulty. Overload operation. Outdoor PCB is faulty.	After the compressor starts, when the compressor stops due to rotor lock.	○ (2 times)	○
	1 - time flash	61	Connection lines between the indoor and outdoor units are faulty	Connection lines are faulty. Indoor or outdoor PCB are faulty.	When 10 seconds passes after the power is turned on without communications signals from the indoor or outdoor unit being detected correctly.	○	—
	2 - time flash	62	Serial transmission error	Indoor or outdoor PCB are faulty. Noise is causing faulty operation.	When 7 minute 35 seconds passes without communications signals from either the outdoor unit or the indoor unit being detected correctly.	○	—
8 - time flash	OFF	80	Indoor unit's fan motor is abnormal	Indoor fan motor is faulty. Connector connections are poor. Indoor PCB is faulty.	When the indoor unit's fan motor is detected to be running at 300 rpm or lower speed with the fan motor in the ON condition while the air conditioner is running.	○	—
	2 - time flash	82	Indoor heat exchanger sensor is abnormal (anomalous stop)	Indoor heat exchanger sensor wire is disconnected. Connector connections are poor.	When a temperature of -28°C or lower is sensed continuously for 40 minutes during heating operation. (the compressor stops).	○	—
	4 - time flash	84	Anti-condensation control	High humidity condition. Humidity sensor is faulty.	Anti-condensation prevention control is operating.	—	○
	5 - time flash	85	Anti-frost control	Indoor unit fan speed drops. Indoor heat exchanger sensor is broken wire.	When the anti-frost control operates and the compressor stops during cooling operation.	—	○
	6 - time flash	86	Heating high pressure control	Heating overload operation. Indoor unit fan speed drops. Indoor heat exchanger sensor is short circuit.	When high pressure control operates during heating operation and the compressor stops.	—	○

Note (1) The number of flashes when in the Service Mode do not include the 1.5 second period when the lights light up at first (start signal). (See the example shown below.)

- In the case of current cut (example: stop code "42")
 The RUN light (10's digit) flashes 4 times and the TIMER light (1's digit) flashes 2 times.
 $4 \times 10 + 2 \times 1 = 42 \rightarrow$ From the table, read the instructions for error code 42, "Current cut".

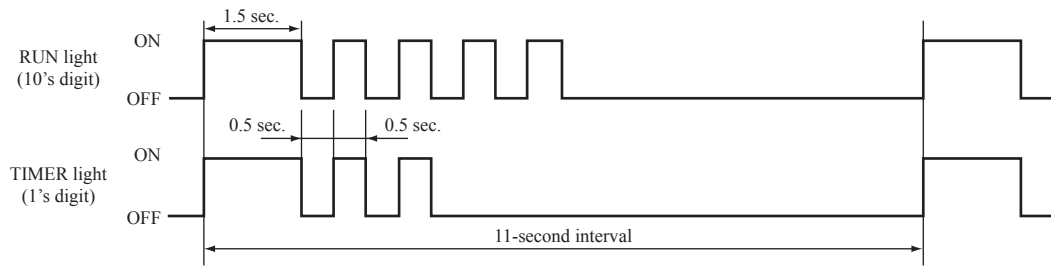

- (2) Abnormal Stop:
 – Is not displayed. (automatic recovery only)
 ○Displayed.
 If there is a () displayed, the error display shows the number of times that an automatic recovery occurred for the same reason has reached the number of times in ().
 If no () is displayed, the error display shows that the trouble has occurred once.
- (3) Automatic Recovery:
 – Does not occur
 ○Automatic recovery occurs.

(d) Remote control information tables

1) Operation switching

Display pattern when in service mode	Operation switching when there is an abnormal stop
RUN light (Operation switching)	
0	AUTO
1	DRY
2	COOL
3	FAN
4	HEAT

2) Fan speed switching

Display pattern when in service mode	Fan speed switching when there is an abnormal stop
TIMER light (Fan speed switching)	
0	AUTO
2	HI
3	MED
4	LO
6	HI POWER
7	ECONO

* If no data are recorded (error code is normal), the information display in the remote control becomes as follows.

Remote control setting	Display when error code is normal.
Operation switching	AUTO
Fan speed switching	AUTO

(Example): Operation switching, fan speed switching, cooling HI

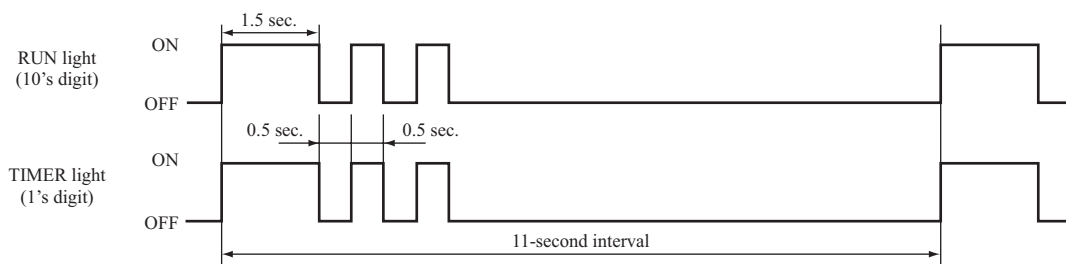

(e) Room temperature sensor temperature, indoor heat exchanger sensor temperature, outdoor air temperature sensor temperature, outdoor heat exchanger sensor temperature table

Units: °C

Buzzer sound		TIMER light (1's digit)														
		0	1	2	3	4	5	6	7	8	9					
Yes (sounds for 0.1 second)	6	-60	-61	-62	-63	-64										
	5	-50	-51	-52	-53	-54	-55	-56	-57	-58	-59					
	4	-40	-41	-42	-43	-44	-45	-46	-47	-48	-49					
	3	-30	-31	-32	-33	-34	-35	-36	-37	-38	-39					
	2	-20	-21	-22	-23	-24	-25	-26	-27	-28	-29					
	1	-10	-11	-12	-13	-14	-15	-16	-17	-18	-19					
	0		-1	-2	-3	-4	-5	-6	-7	-8	-9					
No (does not sound)	0	0	1	2	3	4	5	6	7	8	9					
	1	10	11	12	13	14	15	16	17	18	19					
	2	20	21	22	23	24	25	26	27	28	29					
	3	30	31	32	33	34	35	36	37	38	39					
	4	40	41	42	43	44	45	46	47	48	49					
	5	50	51	52	53	54	55	56	57	58	59					
	6	60	61	62	63	64	65	66	67	68	69					
	7	70	71	72	73	74	75	76	77	78	79					
	8	80	81	82	83	84	85	86	87	88	89					
	9	90	91	92	93	94	95	96	97	98	99					

* If no data are recorded (error code is normal), the display for each sensor becomes as shown below.

Sensor name	Sensor value displayed when the error code is normal
Room temperature sensor temperature	-19°C
Indoor heat exchanger sensor temperature	-64°C
Outdoor air temperature sensor temperature	-64°C
Outdoor heat exchanger sensor temperature	-64°C

(Example) Room temperature, indoor heat exchanger, outdoor air temperature, outdoor heat exchanger: “-9°C”

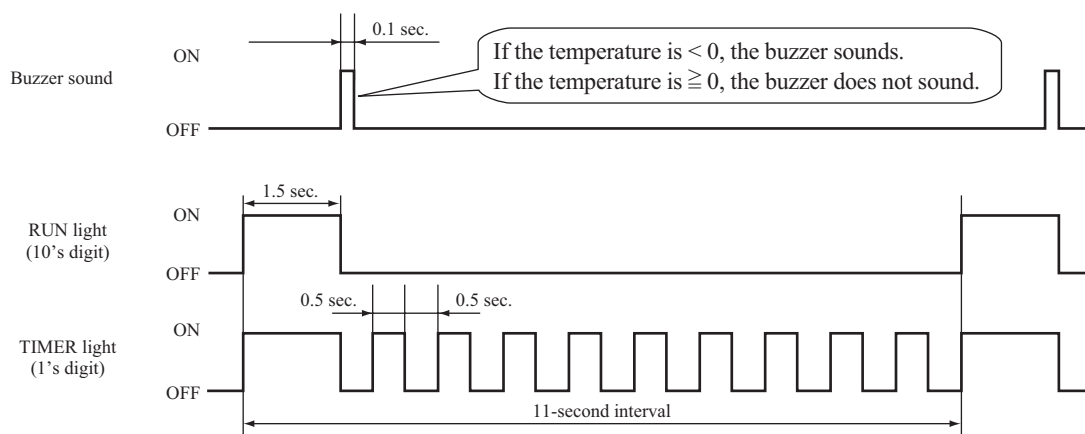

(f) Discharge pipe temperature table

Units: °C

Buzzer sound	RUN light (10's digit)	TIMER light (1's digit)										
		0	1	2	3	4	5	6	7	8	9	
Yes (sounds for 0.1 second)	3	-60	-62	-64								
	2	-40	-42	-44	-46	-48	-50	-52	-54	-56	-58	
	1	-20	-22	-24	-26	-28	-30	-32	-34	-36	-38	
	0	/	-2	-4	-6	-8	-10	-12	-14	-16	-18	
No (does not sound)	0	0	2	4	6	8	10	12	14	16	18	
	1	20	22	24	26	28	30	32	34	36	38	
	2	40	42	44	46	48	50	52	54	56	58	
	3	60	62	64	66	68	70	72	74	76	78	
	4	80	82	84	86	88	90	92	94	96	98	
	5	100	102	104	106	108	110	112	114	116	118	
	6	120	122	124	126	128	130	132	134	136	138	
	7	140	142	144	146	148	150					

* If no data is recorded (error code is normal), the display for sensor becomes as shown below.

Sensor name	Sensor value displayed when the error code is normal
Discharge pipe sensor temperature	-64°C

(Example) Discharge pipe temperature: "122°C"

* In the case of discharge pipe data, multiply the reading value by 2. (Below, 61 x 2 = "122°C")

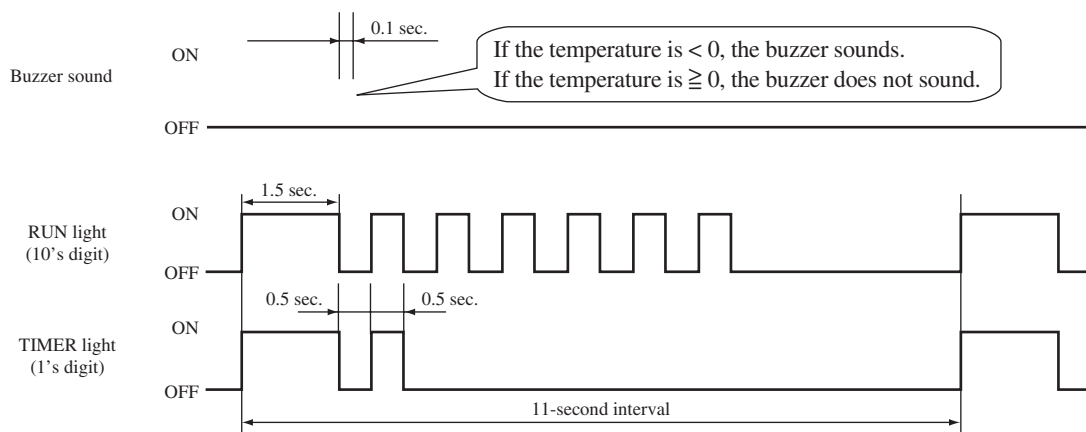

Service data record form

Customer			Model				
Date of investigation							
Machine name							
Content of complaint							
Remote control settings			Content of displayed data	Display results			Display content
Temperature setting	Operation switching	Fan speed switching		Buzzer (Yes/No.)	RUN light (Times)	TIMER light (Times)	
21	Cooling	MED	Error code on previous occasion.	/			
		HI	Room temperature sensor temperature on previous occasion.				
		AUTO	Indoor heat exchanger sensor temperature on previous occasion.				
	Heating	LO	Remote control information on previous occasion.	/			
		MED	Outdoor air temperature sensor temperature on previous occasion.				
		HI	Outdoor heat exchanger sensor temperature on previous occasion.				
22	Cooling	MED	Error code on second previous occasion.	/			
		HI	Room temperature sensor temperature on second previous occasion.				
		AUTO	Indoor heat exchanger sensor temperature on second previous occasion.				
	Heating	LO	Remote control information on second previous occasion.	/			
		MED	Outdoor air temperature sensor temperature on second previous occasion.				
		HI	Outdoor heat exchanger sensor temperature on second previous occasion.				
23	Cooling	MED	Error code on third previous occasion.	/			
		HI	Room temperature sensor temperature on third previous occasion.				
		AUTO	Indoor heat exchanger sensor temperature on third previous occasion.				
	Heating	LO	Remote control information on third previous occasion.	/			
		MED	Outdoor air temperature sensor temperature on third previous occasion.				
		HI	Outdoor heat exchanger sensor temperature on third previous occasion.				
24	Cooling	MED	Error code on fourth previous occasion.	/			
		HI	Room temperature sensor temperature on fourth previous occasion.				
		AUTO	Indoor heat exchanger sensor temperature on fourth previous occasion.				
	Heating	LO	Remote control information on fourth previous occasion.	/			
		MED	Outdoor air temperature sensor temperature on fourth previous occasion.				
		HI	Outdoor heat exchanger sensor temperature on fourth previous occasion.				
25	Cooling	MED	Error code on fifth previous occasion.	/			
		HI	Room temperature sensor temperature on fifth previous occasion.				
		AUTO	Indoor heat exchanger sensor temperature on fifth previous occasion.				
	Heating	LO	Remote control information on fifth previous occasion.	/			
		MED	Outdoor air temperature sensor temperature on fifth previous occasion.				
		HI	Outdoor heat exchanger sensor temperature on fifth previous occasion.				
21	Cooling	LO	Stop code on previous occasion.				
22			Stop code on second previous occasion.				
23			Stop code on third previous occasion.				
24			Stop code on fourth previous occasion.				
25			Stop code on fifth previous occasion.				
26			Stop code on sixth previous occasion.				
27			Stop code on seventh previous occasion.				
28			Stop code on eighth previous occasion.				
29			Stop code on ninth previous occasion.				
30			Stop code on tenth previous occasion.				
Judgment						Examiner	
Remarks							

(7) Inspection procedures corresponding to detail of trouble

Sensor error

[Broken sensor wire, connector poor connection]

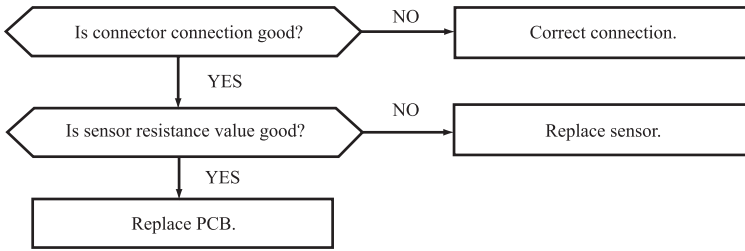

◆ Discharge pipe sensor temperature characteristics

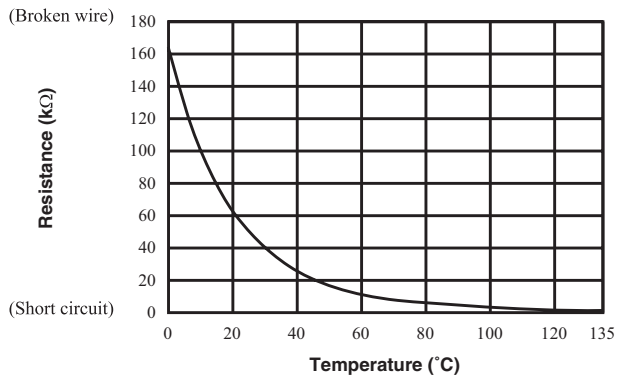

◆ Sensor temperature characteristics (Room temp., indoor heat exchanger temp., outdoor heat exchanger temp., outdoor air temp.)

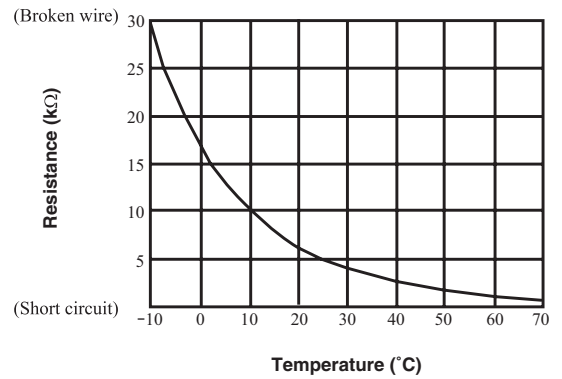

Indoor fan motor error

[Defective fan motor, connector poor connection, defective indoor PCB]

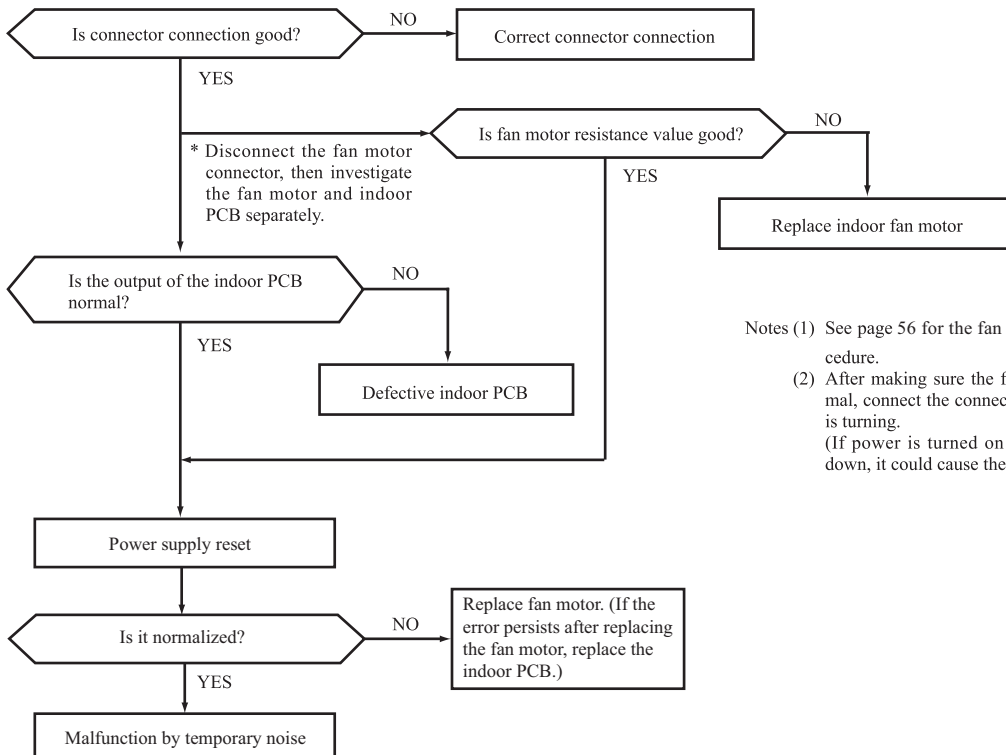

Notes (1) See page 56 for the fan motor and indoor PCB check procedure.

(2) After making sure the fan motor and indoor PCB are normal, connect the connectors and confirm that the fan motor is turning.

(If power is turned on while one or the other is broken down, it could cause the other to break down also.)

Current cut

[Compressor lock, Compressor wiring short circuit, Compressor output is open phase, Outdoor PCB is faulty, Service valve is closed, EEV is faulty, Compressor faulty.]

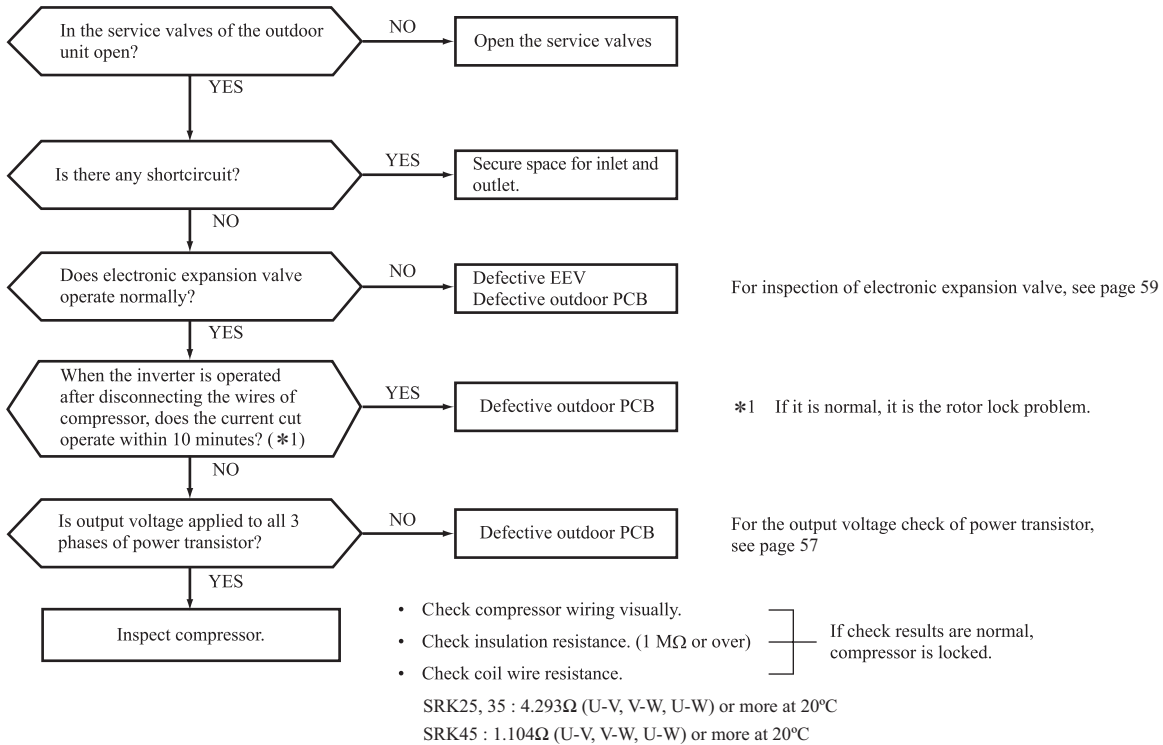

Current safe stop

[Overload operation, compressor lock, overcharge]

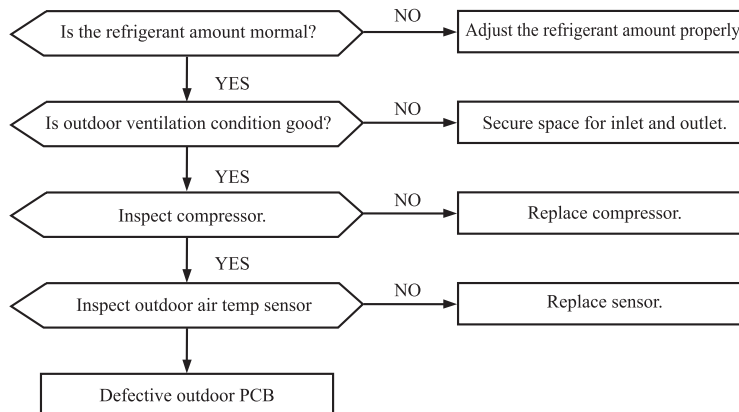

Over heat of compressor

[Gas shortage, defective discharge pipe sensor]

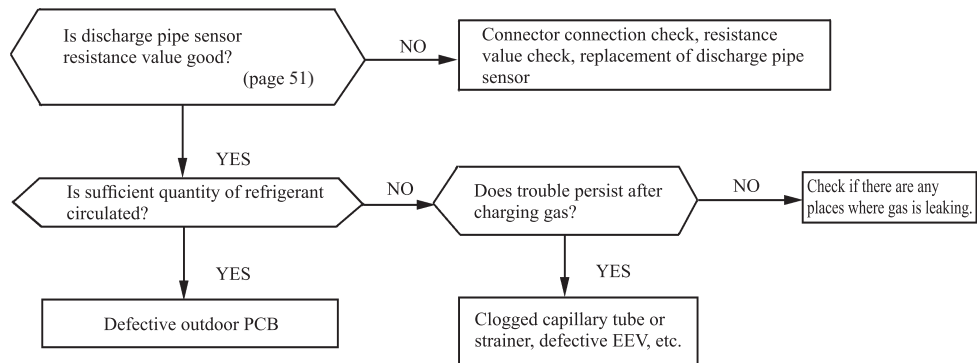

Error of signal transmission

[Wiring error including power cable, defective indoor/ outdoor PCB]

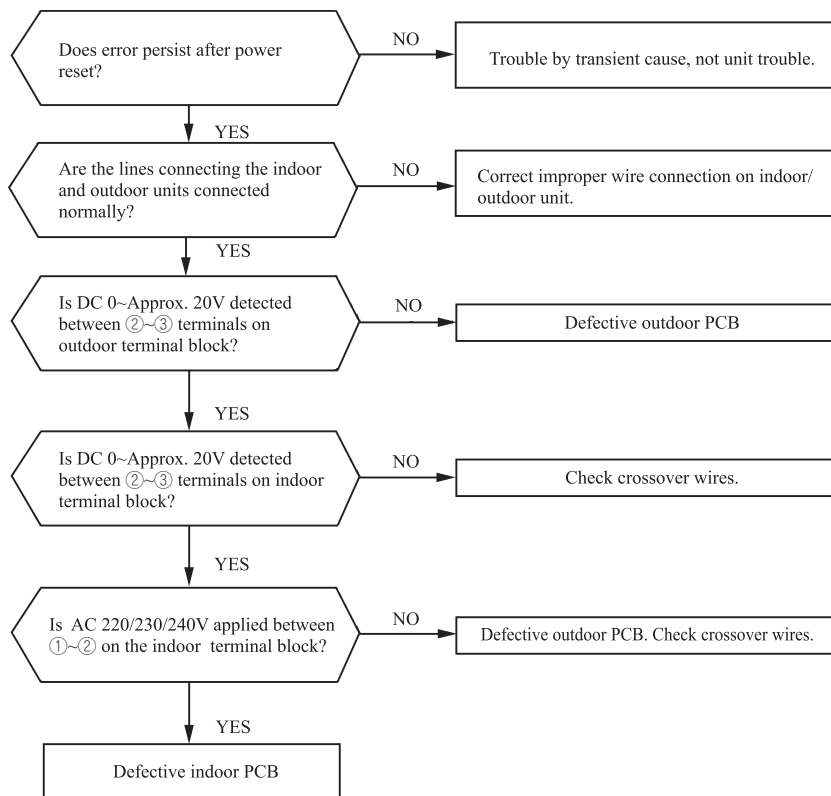

Trouble of outdoor unit

[Insufficient refrigerant amount, Faulty power transistor, Broken compressor wire]
 [Service valve close, Defective EEV, Defective outdoor PCB]

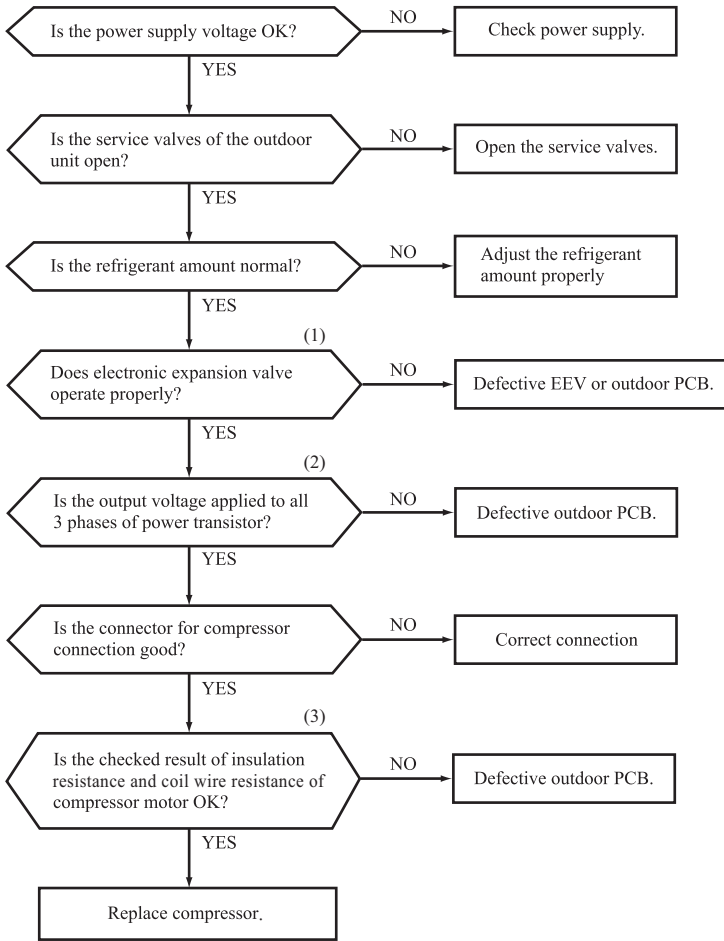

Proper power supply voltages are as follows.
 (At the power supply outlet)
 AC 220V : AC 198~242V
 AC 230V : AC 207~253V
 AC 240V : AC 216~264V

- ◆ Judgment of refrigerant quantity
- (1) Phenomenon of insufficient refrigerant
 - (a) Loss of capacity
 - (b) Poor defrosting
(Frost is not removed completely.)
 - (c) Longer time of hot keep
(5 minute or more)
(Normal time: Approx. 1 – 1 minute and 30 seconds)

Notes (1) For inspection of electronic expansion valve, see page 59
 (2) For the output voltage check of power transistor, see page 57
 (3) Check coil wire resistance, see page 52.

Outdoor fan motor error

[Defective fan motor, connector poor connection, defective outdoor PCB]

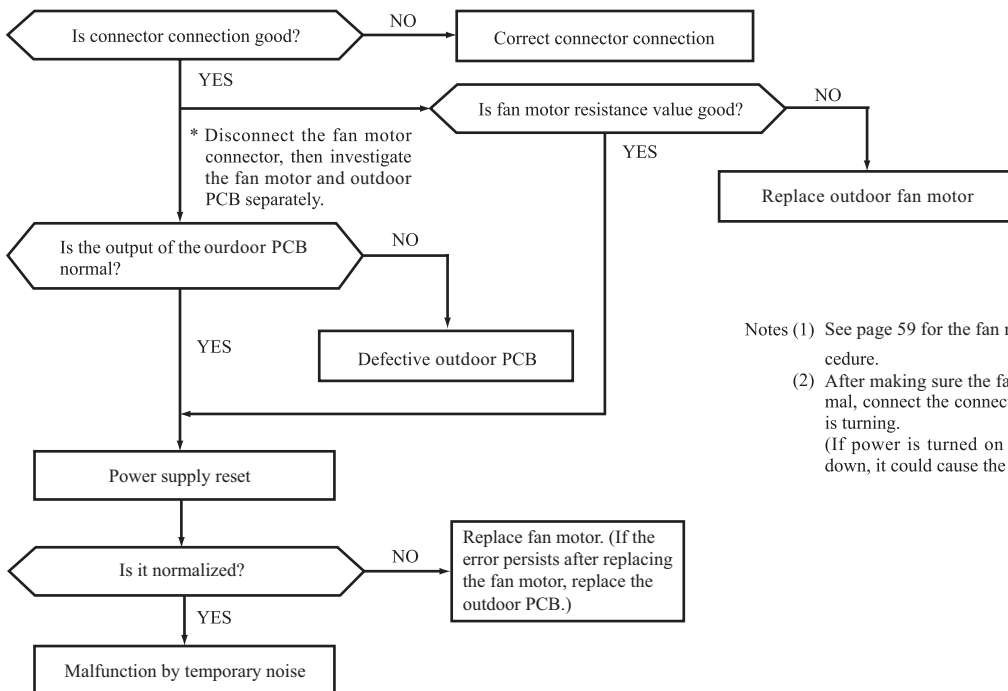

Notes (1) See page 59 for the fan motor and outdoor PCB check procedure.
 (2) After making sure the fan motor and outdoor PCB are normal, connect the connectors and confirm that the fan motor is turning.
 (If power is turned on while one or the other is broken down, it could cause the other to break down also.)

Rotor lock

[Defective compressor, defective outdoor PCB]

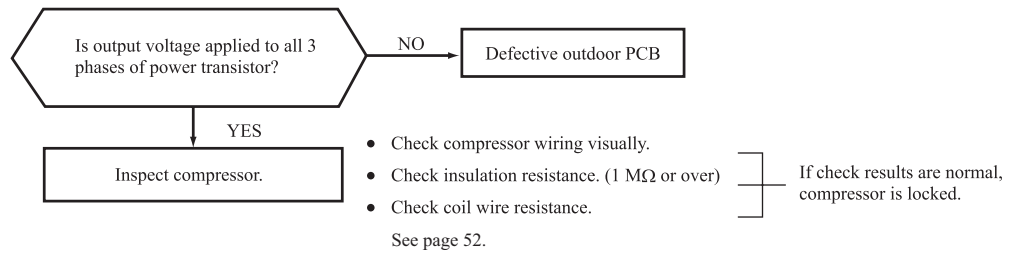

(8) Phenomenon observed after shortcircuit, wire breakage on sensor

(a) Indoor unit

Sensor	Operation mode	Phenomenon	
		Shortcircuit	Disconnected wire
Room temperature sensor	Cooling	Release of continuous compressor operation command.	Continuous compressor operation command is not released.
	Heating	Continuous compressor operation command is not released.	Release of continuous compressor operation command.
Heat exchanger sensor	Cooling	System can be operated normally.	Continuous compressor operation command is not released. (Anti-frosting)
	Heating	High pressure control mode (Compressor stop command)	Hot keep (Indoor fan stop)
Humidity sensor	Cooling	Refer to the table below.	Refer to the table below.
	Heating	Normal system operation is possible.	

■ Humidity sensor operation

Failure mode	Control input circuit reading	Air conditioning system operation
Disconnected wire	① Disconnected wire	Humidity reading is 0% Anti-condensation control is not done.
	② Disconnected wire	
	①② Disconnected wire	
Short Circuit	① and ② are short circuited	Humidity reading is 100% Anti-condensation control keep doing.

Remark: Do not perform a continuity check of the humidity sensor with a tester. If DC current is applied, it could damage the sensor.

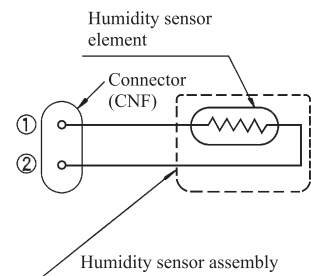

(b) Outdoor unit

Sensor	Operation mode	Phenomenon	
		Shortcircuit	Disconnected wire
Heat exchanger sensor	Cooling	System can be operated normally.	Compressor stop.
	Heating	Defrosting is not performed.	Defrosting is performed for 10 minutes at approx. 35 (model SRK35:45) minutes.
Outdoor air temperature sensor	Cooling	System can be operated normally.	Compressor stop.
	Heating	Defrosting is not operated.	Defrosting is performed for 10 minutes at approx. 35 (model SRK35:45) minutes.
Discharge pipe sensor	All modes	Compressor overload protection is disabled. (Can be operated.)	Compressor stop

(9) Checking the indoor electrical equipment

(a) Indoor PCB check procedure

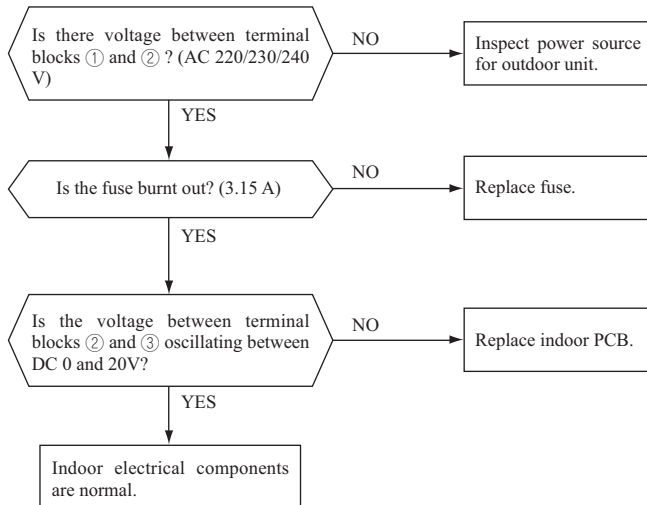

(b) Indoor unit fan motor check procedure

This is a diagnostic procedure for determining if the indoor unit's fan motor or the indoor PCB is broken down.

1) Indoor PCB output check

- a) Turn off the power.
- b) Remove the front panel, then disconnect the fan motor lead wire connector.
- c) Turn on the power. If the unit operates when the ON/OFF button is pressed, if trouble is detected after the voltages in the following figure are output for approximately 30 seconds, it means that the indoor PCB is normal and the fan motor is broken down.

If the voltages in the following figure are not output at connector pins No. ①, ④ and ⑤, the indoor PCB has failed and the fan motor is normal.

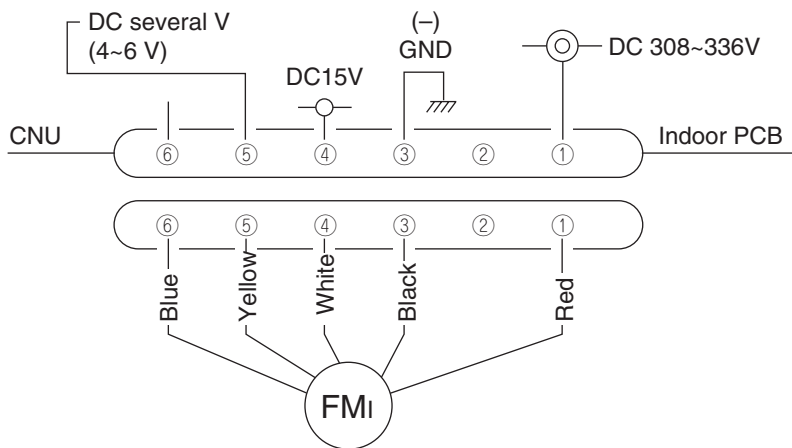

Measuring point	Resistance when normal
① - ③	DC 308~336V
④ - ③	DC 15V
⑤ - ③	DC several V (4~6V)
⑥ - ③	DC several V (4~6V)

2) Fan motor resistance check

Measuring point	Resistance when normal
① - ③ (Red - Black)	20 MΩ or higher
④ - ③ (White - Black)	20 kΩ or higher

- Notes (1) Remove the fan motor and measure it without power connected to it.
 (2) If the measured value is below the value when the motor is normal, it means that the fan motor is faulty.

(C) Power transistor inspection procedure

[Use a tester with a needle indicator for the inspection. (Do not use a digital tester. Check in the AC 300 volt range.)]

(1) If there is a self-diagnosis display, inspect the compressor system (burns, wiring mistakes, etc.) If no problems are found, check the output of the power transistor.

(2) Output inspection procedure

Disconnect the terminals for the compressor.

If an output such as the one shown in the figure on the below can be measured, the power transistor and the circuit board for the outdoor unit are normal.

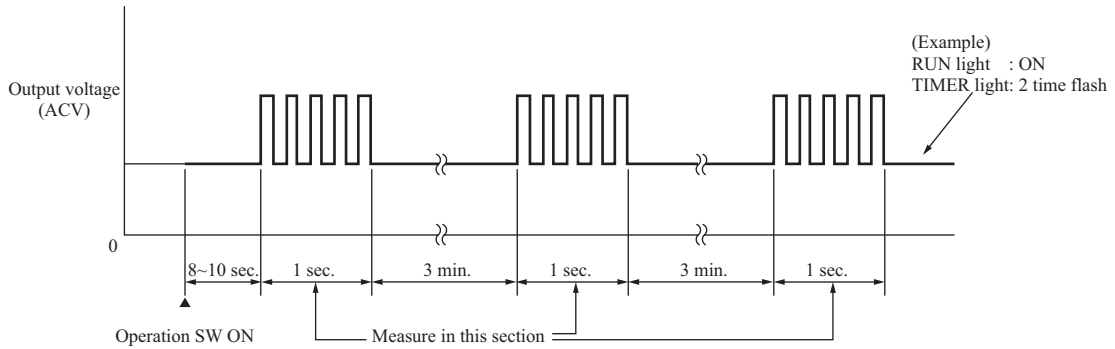

(10) How to make sure of wireless remote control

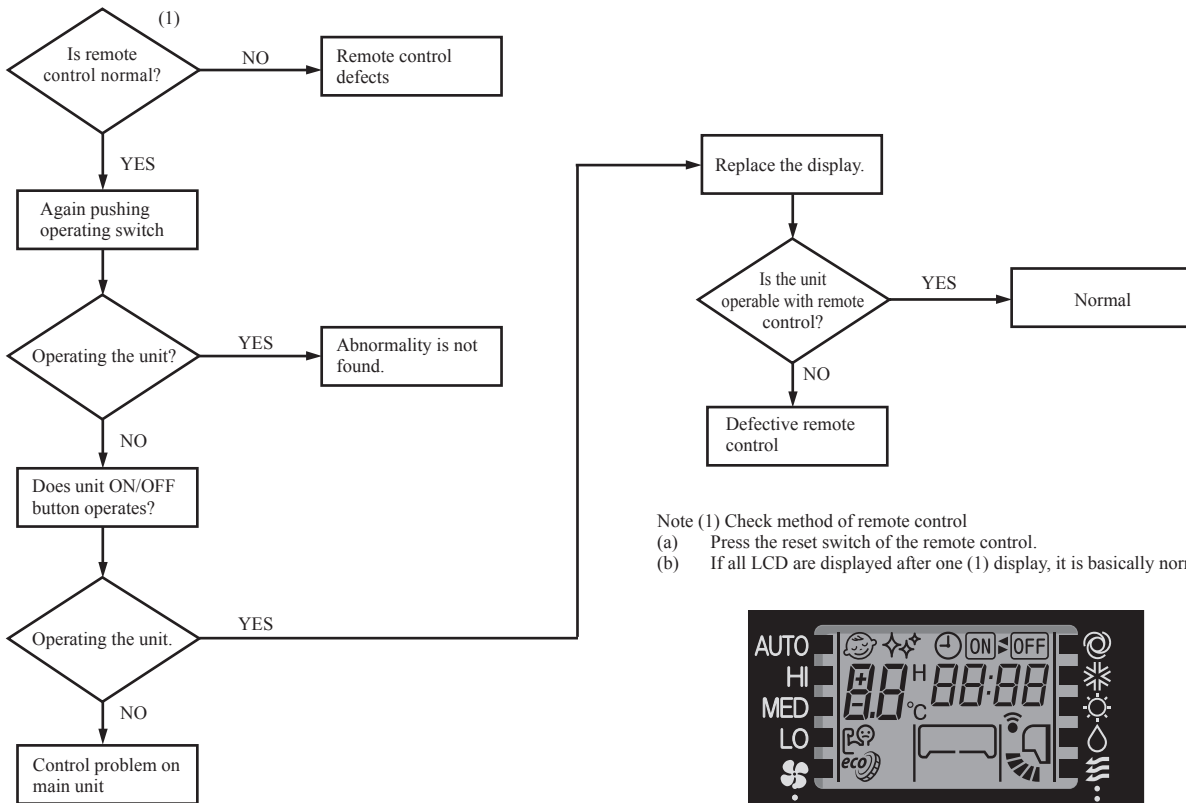

Note (1) Check method of remote control

(a) Press the reset switch of the remote control.

(b) If all LCD are displayed after one (1) display, it is basically normal.

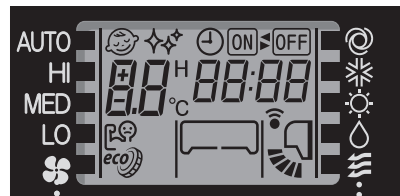

◆ Check point of outdoor unit

⚠ CAUTION – HIGH VOLTAGE
 High voltage is produced in the control box. Don't touch electrical parts in the control box for 5 minutes after the unit is stopped.

Color symbol

Mark	Color
BK	Black
OR	Orange
RD	Red
WH	White
Y	Yellow
Y/G	Yellow/Green

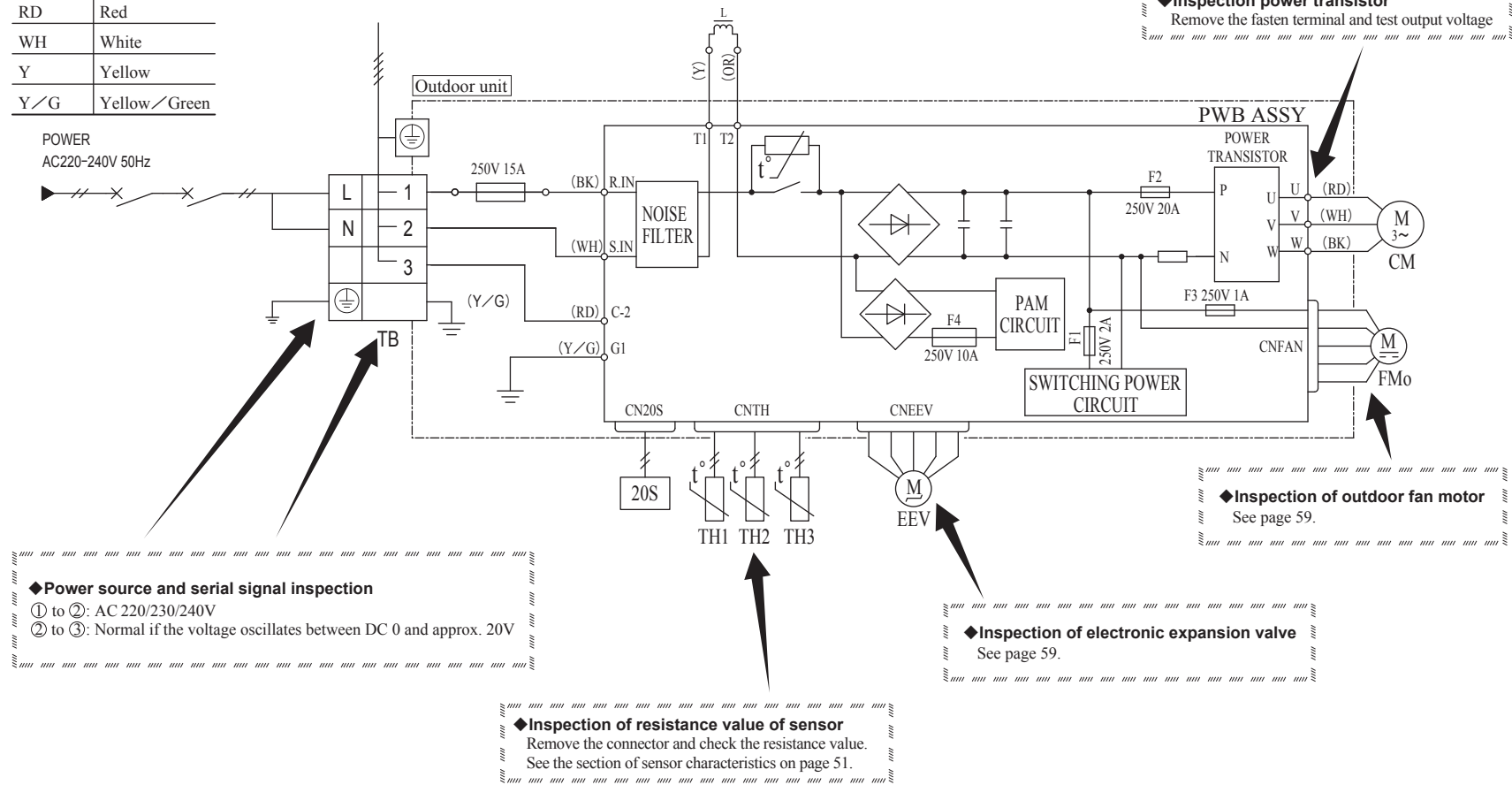

(a) Inspection of electronic expansion valve

Electronic expansion valve operates for approx. 10 seconds after the power on, in order to determine its aperture. Check the operating sound and voltage during the period of time. (Voltage cannot be checked during operation in which only the aperture change occurs.)

- (i) If it is heard the sound of operating electronic expansion valve, it is almost normal.
- (ii) If the operating sound is not heard, check the output voltage.

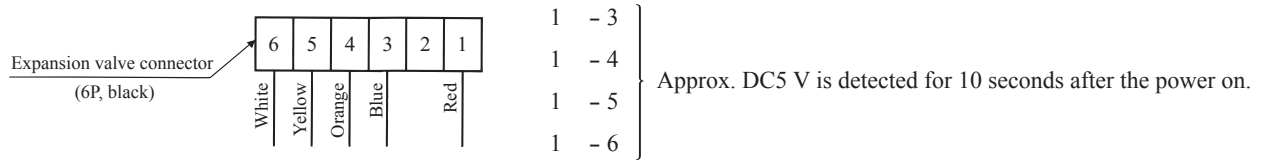

- (iii) If voltage is detected, the outdoor PCB is normal.
- (iv) If the expansion valve does not operate (no operating sound) while voltage is detected, the expansion valve is defective.

• Inspection of electronic expansion valve as a separate unit

Measure the resistance between terminals with an analog tester.

Measuring point	Resistance when normal
1-6	46 ± 4Ω (at 20°C)
1-4	
1-3	
1-5	

(b) Outdoor unit fan motor check procedure

- When the outdoor unit fan motor error is detected, diagnose which of the outdoor unit fan motor or outdoor PCB is defective.
- Diagnose this only after confirming that the indoor unit is normal.

(i) Outdoor PCB output check

- 1) Turn off the power.
- 2) Disconnect the outdoor unit fan motor connector CNFAN.
- 3) When the indoor unit is operated by inserting the power supply plug and pressing (ON) the backup switch for more than 5 seconds, if the voltage of pin No. ② in the following figure is output for 30 seconds at 20 seconds after turning “ON” the backup switch, the outdoor PCB is normal but the fan motor is defective.

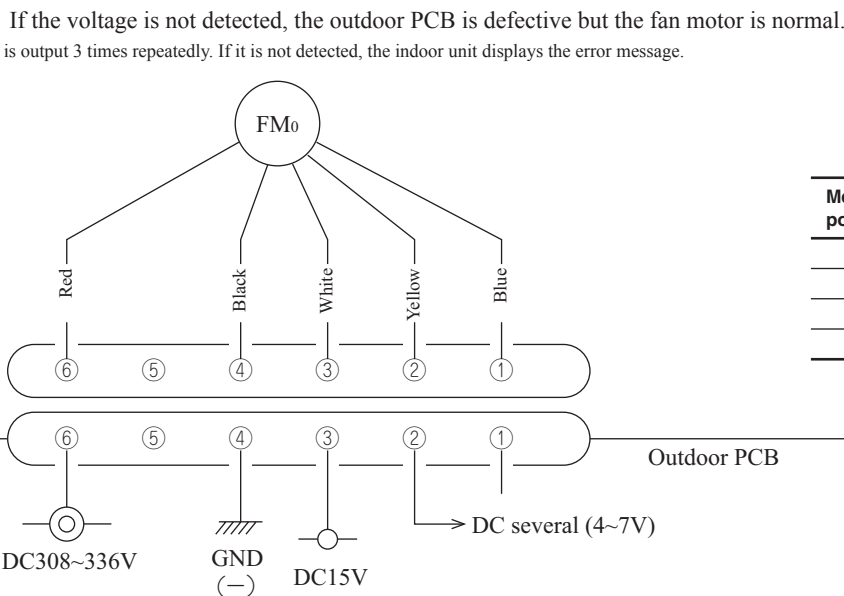

Measuring point	Resistance when normal
⑥ - ④	DC 308~336V
③ - ④	DC 15V
② - ④	DC several V (4~7V)
① - ④	DC several V (4~7V)

Note (1) The voltage is output 3 times repeatedly. If it is not detected, the indoor unit displays the error message.

(ii) Fan motor resistance check

Measuring point	Resistance when normal
⑥ - ④ (Red - Black)	20 MΩ or higher
③ - ④ (White - Black)	20 kΩ or higher

- Notes (1) Remove the fan motor and measure it without power connected to it.
- (2) If the measured value is below the value when the motor is normal, it means that the fan motor is faulty.

11. TECHNICAL INFORMATION

Model SRK25ZMP-S

Information to identify the model(s) to which the information relates to:				If function includes heating: Indicate the heating season the information relates to. Indicated values should relate to one heating season at a time. Include at least the heating season 'Average'.					
Indoor unit model name		SRK25ZMP-S		Average(mandatory)		Yes			
Outdoor unit model name		SRC25ZMP-S		Warmer(if designated)		Yes			
Function(indicate if present)				Colder(if designated)				No	
cooling		Yes							
heating		Yes							
Item	symbol	value	unit	Item	symbol	value	class		
Design load				Seasonal efficiency and energy efficiency class					
cooling	Pdesignc	2.5	kW	cooling	SEER	5.50	A		
heating / Average	Pdesignh	2.8	kW	heating / Average	SCOP/A	3.82	A		
heating / Warmer	Pdesignh	-	kW	heating / Warmer	SCOP/W	-	-		
heating / Colder	Pdesignh	-	kW	heating / Colder	SCOP/C	-	-		
				unit					
Declared capacity at outdoor temperature Tdesignh				Back up heating capacity at outdoor temperature Tdesignh					
heating / Average (-10°C)	Pdh	2.34	kW	heating / Average (-10°C)	elbu	0.46	kW		
heating / Warmer (2°C)	Pdh	2.8	kW	heating / Warmer (2°C)	elbu	-	kW		
heating / Colder (-22°C)	Pdh	-	kW	heating / Colder (-22°C)	elbu	-	kW		
Declared capacity for cooling, at indoor temperature 27(19)°C and outdoor temperature Tj				Declared energy efficiency ratio, at indoor temperature 27(19)°C and outdoor temperature Tj					
Tj=35°C	Pdc	2.5	kW	Tj=35°C	EERd	3.21	-		
Tj=30°C	Pdc	1.84	kW	Tj=30°C	EERd	4.87	-		
Tj=25°C	Pdc	1.29	kW	Tj=25°C	EERd	8.18	-		
Tj=20°C	Pdc	1.78	kW	Tj=20°C	EERd	8.13	-		
Declared capacity for heating / Average season, at indoor temperature 20°C and outdoor temperature Tj				Declared coefficient of performance / Average season, at indoor temperature 20°C and outdoor temperature Tj					
Tj=-7°C	Pdh	2.48	kW	Tj=-7°C	COPd	2.17	-		
Tj=2°C	Pdh	1.51	kW	Tj=2°C	COPd	3.9	-		
Tj=7°C	Pdh	0.97	kW	Tj=7°C	COPd	5.14	-		
Tj=12°C	Pdh	1.02	kW	Tj=12°C	COPd	6.22	-		
Tj=bivalent temperature	Pdh	2.48	kW	Tj=bivalent temperature	COPd	2.17	-		
Tj=operating limit	Pdh	2.1	kW	Tj=operating limit	COPd	1.97	-		
Declared capacity for heating / Warmer season, at indoor temperature 20°C and outdoor temperature Tj				Declared coefficient of performance / Warmer season, at indoor temperature 20°C and outdoor temperature Tj					
Tj=2°C	Pdh	-	kW	Tj=2°C	COPd	-	-		
Tj=7°C	Pdh	-	kW	Tj=7°C	COPd	-	-		
Tj=12°C	Pdh	-	kW	Tj=12°C	COPd	-	-		
Tj=bivalent temperature	Pdh	-	kW	Tj=bivalent temperature	COPd	-	-		
Tj=operating limit	Pdh	-	kW	Tj=operating limit	COPd	-	-		
Declared capacity for heating / Colder season, at indoor temperature 20°C and outdoor temperature Tj				Declared coefficient of performance / Colder season, at indoor temperature 20°C and outdoor temperature Tj					
Tj=-7°C	Pdh	-	kW	Tj=-7°C	COPd	-	-		
Tj=2°C	Pdh	-	kW	Tj=2°C	COPd	-	-		
Tj=7°C	Pdh	-	kW	Tj=7°C	COPd	-	-		
Tj=12°C	Pdh	-	kW	Tj=12°C	COPd	-	-		
Tj=bivalent temperature	Pdh	-	kW	Tj=bivalent temperature	COPd	-	-		
Tj=operating limit	Pdh	-	kW	Tj=operating limit	COPd	-	-		
Tj=-15°C	Pdh	-	kW	Tj=-15°C	COPd	-	-		
Bivalent temperature				Operating limit temperature					
heating / Average	Tbiv	-7	°C	heating / Average	Tol	-15	°C		
heating / Warmer	Tbiv	-	°C	heating / Warmer	Tol	-	°C		
heating / Colder	Tbiv	-	°C	heating / Colder	Tol	-	°C		
Cycling interval capacity				Cycling interval efficiency					
for cooling	Pcycc	-	kW	for cooling	EERcyc	-	-		
for heating	Pcyhc	-	kW	for heating	COPcyc	-	-		
Degradation coefficient				Degradation coefficient					
cooling	Cdc	0.25	-	heating	Cdh	0.25	-		
Electric power input in power modes other than 'active mode'				Annual electricity consumption					
off mode	Poff	6	W	cooling	Qce	160	kWh/a		
standby mode	Psb	6	W	heating / Average	Qhe	1027	kWh/a		
thermostat-off mode	Pto	25	W	heating / Warmer	Qhe	-	kWh/a		
crankcase heater mode	Pck	0	W	heating / colder	Qhe	-	kWh/a		
Capacity control(indicate one of three options)				Other items					
fixed		No		Sound power level(indoor)	Lwa	59	dB(A)		
staged		No		Sound power level(outdoor)	Lwa	60	dB(A)		
variable		Yes		Global warming potential	GWp	1975	kgCO2eq.		
				Rated air flow(indoor)	-	606	m3/h		
				Rated air flow(outdoor)	-	1560	m3/h		
Contact details for obtaining more information	Name and address of the manufacturer or of its authorised representative. Mitsubishi Heavy Industries Air-Conditioning Europe, Ltd. 7 Roundwood Avenue, Stockley Park, Uxbridge, Middlesex, UB11 1AX, United Kingdom								

RWA000Z249

Model SRK35ZMP-S

Information to identify the model(s) to which the information relates to:		If function includes heating: Indicate the heating season the information relates to. Indicated values should relate to one heating season at a time. Include at least the heating season 'Average'.	
Indoor unit model name	SRK35ZMP-S		
Outdoor unit model name	SRC35ZMP-S		
Function(indicate if present)		Average(mandatory)	
cooling	Yes	Warmer(if designated)	No
heating	Yes	Colder(if designated)	No
Item	symbol	value	unit
Design load			
cooling	Pdesignc	3.2	kW
heating / Average	Pdesignh	3	kW
heating / Warmer (2°C)	Pdesignh	-	kW
heating / Colder	Pdesignh	-	kW
Seasonal efficiency and energy efficiency class			
cooling	SEER	6.15	A++
heating / Average	SCOP/A	4.00	A+
heating / Warmer (2°C)	SCOP/W	-	-
heating / Colder	SCOP/C	-	-
Declared capacity at outdoor temperature Tdesignh			
heating / Average (-10°C)	Pdh	2.54	kW
heating / Warmer (2°C)	Pdh	-	kW
heating / Colder (-22°C)	Pdh	-	kW
Back up heating capacity at outdoor temperature Tdesignh			
heating / Average (-10°C)	elbu	0.46	kW
heating / Warmer (2°C)	elbu	-	kW
heating / Colder (-22°C)	elbu	-	kW
Declared capacity for cooling, at indoor temperature 27(19)°C and outdoor temperature Tj			
Tj=35°C	Pdc	3.2	kW
Tj=30°C	Pdc	2.36	kW
Tj=25°C	Pdc	1.52	kW
Tj=20°C	Pdc	1.86	kW
Declared energy efficiency ratio, at indoor temperature 27(19)°C and outdoor temperature Tj			
Tj=35°C	EERd	3.22	-
Tj=30°C	EERd	5.16	-
Tj=25°C	EERd	8.97	-
Tj=20°C	EERd	9.75	-
Declared capacity for heating / Average season, at indoor temperature 20°C and outdoor temperature Tj			
Tj=-7°C	Pdh	2.65	kW
Tj=2°C	Pdh	1.62	kW
Tj=7°C	Pdh	1.04	kW
Tj=12°C	Pdh	1.07	kW
Tj=bivalent temperature	Pdh	2.65	kW
Tj=operating limit	Pdh	2.35	kW
Declared coefficient of performance / Average season, at indoor temperature 20°C and outdoor temperature Tj			
Tj=-7°C	COPd	2.28	-
Tj=2°C	COPd	4.08	-
Tj=7°C	COPd	5.34	-
Tj=12°C	COPd	6.54	-
Tj=bivalent temperature	COPd	2.28	-
Tj=operating limit	COPd	2.13	-
Declared capacity for heating / Warmer season, at indoor temperature 20°C and outdoor temperature Tj			
Tj=2°C	Pdh	-	kW
Tj=7°C	Pdh	-	kW
Tj=12°C	Pdh	-	kW
Tj=bivalent temperature	Pdh	-	kW
Tj=operating limit	Pdh	-	kW
Declared coefficient of performance / Warmer season, at indoor temperature 20°C and outdoor temperature Tj			
Tj=2°C	COPd	-	-
Tj=7°C	COPd	-	-
Tj=12°C	COPd	-	-
Tj=bivalent temperature	COPd	-	-
Tj=operating limit	COPd	-	-
Declared capacity for heating / Colder season, at indoor temperature 20°C and outdoor temperature Tj			
Tj=-7°C	Pdh	-	kW
Tj=2°C	Pdh	-	kW
Tj=7°C	Pdh	-	kW
Tj=12°C	Pdh	-	kW
Tj=bivalent temperature	Pdh	-	kW
Tj=operating limit	Pdh	-	kW
Tj=-15°C	Pdh	-	kW
Declared coefficient of performance / Colder season, at indoor temperature 20°C and outdoor temperature Tj			
Tj=-7°C	COPd	-	-
Tj=2°C	COPd	-	-
Tj=7°C	COPd	-	-
Tj=12°C	COPd	-	-
Tj=bivalent temperature	COPd	-	-
Tj=operating limit	COPd	-	-
Tj=-15°C	COPd	-	-
Bivalent temperature			
heating / Average	Tbiv	-7	°C
heating / Warmer	Tbiv	-	°C
heating / Colder	Tbiv	-	°C
Operating limit temperature			
heating / Average	Tol	-15	°C
heating / Warmer	Tol	-	°C
heating / Colder	Tol	-	°C
Cycling interval capacity			
for cooling	Pcycc	-	kW
for heating	Pcyhc	-	kW
Cycling interval efficiency			
for cooling	EERcyc	-	-
for heating	COPcyc	-	-
Degradation coefficient			
cooling	Cdc	0.25	-
Degradation coefficient			
heating	Cdh	0.25	-
Electric power input in power modes other than 'active mode'			
off mode	Poff	6	W
standby mode	Psb	6	W
thermostat-off mode	Pto	25	W
crankcase heater mode	Pck	0	W
Annual electricity consumption			
cooling	Qce	183	kWh/a
heating / Average	Qhe	1052	kWh/a
heating / Warmer	Qhe	-	kWh/a
heating / colder	Qhe	-	kWh/a
Capacity control(indicate one of three options)			
fixed		No	
staged		No	
variable		Yes	
Other items			
Sound power level(indoor)	Lwa	60	dB(A)
Sound power level(outdoor)	Lwa	60	dB(A)
Global warming potential	GWP	1975	kgCO2eq.
Rated air flow(indoor)	-	570	m3/h
Rated air flow(outdoor)	-	1524	m3/h
Contact details for obtaining more information	Name and address of the manufacturer or of its authorised representative. Mitsubishi Heavy Industries Air-Conditioning Europe, Ltd. 7 Roundwood Avenue, Stockley Park, Uxbridge, Middlesex, UB11 1AX, United Kingdom		

RWA000Z249

Model SRK45ZMP-S

Information to identify the model(s) to which the information relates to:				If function includes heating: Indicate the heating season the information relates to. Indicated values should relate to one heating season at a time. Include at least the heating season 'Average'.			
Indoor unit model name		SRK45ZMP-S		Average(mandatory)		Yes	
Outdoor unit model name		SRC45ZMP-S		Warmer(if designated)		No	
Function(indicate if present)				Colder(if designated)		No	
cooling		Yes					
heating		Yes					
Item	symbol	value	unit	Item	symbol	value	class
Design load				Seasonal efficiency and energy efficiency class			
cooling	Pdesignc	4.5	kW	cooling	SEER	5.38	A
heating / Average	Pdesignh	3.8	kW	heating / Average	SCOP/A	5.81	A
heating / Warmer	Pdesignh	-	kW	heating / Warmer	SCOP/W	-	-
heating / Colder	Pdesignh	-	kW	heating / Colder	SCOP/C	-	-
				unit			
Declared capacity at outdoor temperature Tdesignh				Back up heating capacity at outdoor temperature Tdesignh			
heating / Average (-10°C)	Pdh	3.35	kW	heating / Average (-10°C)	elbu	0.46	kW
heating / Warmer (2°C)	Pdh	-	kW	heating / Warmer (2°C)	elbu	-	kW
heating / Colder (-22°C)	Pdh	-	kW	heating / Colder (-22°C)	elbu	-	kW
Declared capacity for cooling, at indoor temperature 27(19)°C and outdoor temperature Tj				Declared energy efficiency ratio, at indoor temperature 27(19)°C and outdoor temperature Tj			
Tj=35°C	Pdc	4.5	kW	Tj=35°C	EERd	3.01	-
Tj=30°C	Pdc	3.32	kW	Tj=30°C	EERd	4.73	-
Tj=25°C	Pdc	2.13	kW	Tj=25°C	EERd	7.54	-
Tj=20°C	Pdc	2.68	kW	Tj=20°C	EERd	7.31	-
Declared capacity for heating / Average season, at indoor temperature 20°C and outdoor temperature Tj				Declared coefficient of performance / Average season, at indoor temperature 20°C and outdoor temperature Tj			
Tj=-7°C	Pdh	3.36	kW	Tj=-7°C	COPd	2.32	-
Tj=2°C	Pdh	2.05	kW	Tj=2°C	COPd	3.78	-
Tj=7°C	Pdh	1.32	kW	Tj=7°C	COPd	5.1	-
Tj=12°C	Pdh	1.35	kW	Tj=12°C	COPd	6.2	-
Tj=bivalent temperature	Pdh	3.36	kW	Tj=bivalent temperature	COPd	2.32	-
Tj=operating limit	Pdh	3.32	kW	Tj=operating limit	COPd	2.15	-
Declared capacity for heating / Warmer season, at indoor temperature 20°C and outdoor temperature Tj				Declared coefficient of performance / Warmer season, at indoor temperature 20°C and outdoor temperature Tj			
Tj=2°C	Pdh	-	kW	Tj=2°C	COPd	-	-
Tj=7°C	Pdh	-	kW	Tj=7°C	COPd	-	-
Tj=12°C	Pdh	-	kW	Tj=12°C	COPd	-	-
Tj=bivalent temperature	Pdh	-	kW	Tj=bivalent temperature	COPd	-	-
Tj=operating limit	Pdh	-	kW	Tj=operating limit	COPd	-	-
Declared capacity for heating / Colder season, at indoor temperature 20°C and outdoor temperature Tj				Declared coefficient of performance / Colder season, at indoor temperature 20°C and outdoor temperature Tj			
Tj=-7°C	Pdh	-	kW	Tj=-7°C	COPd	-	-
Tj=2°C	Pdh	-	kW	Tj=2°C	COPd	-	-
Tj=7°C	Pdh	-	kW	Tj=7°C	COPd	-	-
Tj=12°C	Pdh	-	kW	Tj=12°C	COPd	-	-
Tj=bivalent temperature	Pdh	-	kW	Tj=bivalent temperature	COPd	-	-
Tj=operating limit	Pdh	-	kW	Tj=operating limit	COPd	-	-
Tj=-15°C	Pdh	-	kW	Tj=-15°C	COPd	-	-
Bivalent temperature				Operating limit temperature			
heating / Average	Tbiv	-7	°C	heating / Average	Tol	-15	°C
heating / Warmer	Tbiv	-	°C	heating / Warmer	Tol	-	°C
heating / Colder	Tbiv	-	°C	heating / Colder	Tol	-	°C
Cycling interval capacity				Cycling interval efficiency			
for cooling	Pcycc	-	kW	for cooling	EERcyc	-	-
for heating	Pcyh	-	kW	for heating	COPcyc	-	-
Degradation coefficient				Degradation coefficient			
cooling	Cdc	0.25	-	heating	Cdh	0.25	-
Electric power input in power modes other than 'active mode'				Annual electricity consumption			
off mode	Poff	7	W	cooling	Qce	293	kWh/a
standby mode	Psb	7	W	heating / Average	Qhe	1398	kWh/a
thermostat-off mode	Pto	31	W	heating / Warmer	Qhe	-	kWh/a
crankcase heater mode	Pck	0	W	heating / colder	Qhe	-	kWh/a
Capacity control(indicate one of three options)				Other items			
fixed		No		Sound power level(indoor)	Lwa	60	dB(A)
staged		No		Sound power level(outdoor)	Lwa	65	dB(A)
variable		Yes		Global warming potential	GWP	1975	kgCO2eq.
				Rated air flow(indoor)	-	534	m3/h
				Rated air flow(outdoor)	-	2130	m3/h
Contact details for obtaining more information	Name and address of the manufacturer or of its authorised representative. Mitsubishi Heavy Industries Air-Conditioning Europe, Ltd. 7 Roundwood Avenue, Stockley Park, Uxbridge, Middlesex, UB11 1AX, United Kingdom						

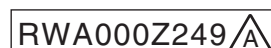

INVERTER WALL MOUNTED TYPE RESIDENTIAL AIR-CONDITIONERS



Air-Conditioning & Refrigeration Systems

16-5, Konan 2-chome, Minato-ku, Tokyo, 108-8215 Japan

<http://www.mhi.co.jp>

Because of our policy of continuous improvement, we reserve the right to make changes in all specifications without notice.

© Copyright MITSUBISHI HEAVY INDUSTRIES, LTD.