

GRUNEWALD - 4,03m²

Caseta Metálica
Metal Shed
Maison Metal
Casota de metal

REF: KIS12100

EAN: 8445401010791

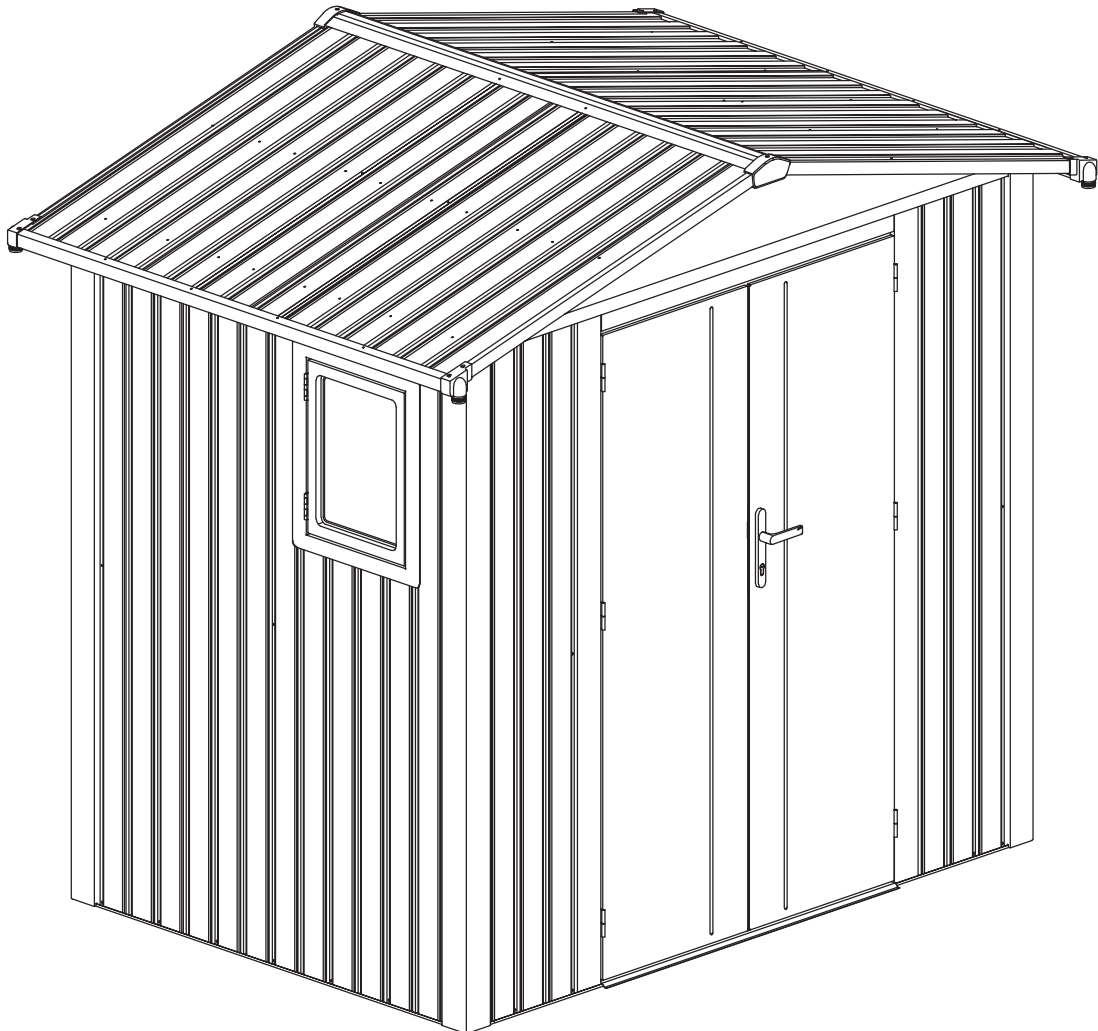

ES Manual de instrucciones

EN Instruction manual

FR Instructions de service

PT Manual de instruções

Gardiun
SPACES TO ENJOY

Manual del Usuario

Por favor, consulte la normativa referente a la construcción, ubicación y otros requerimientos antes de comenzar la instalación de su caseta metálica. Repase este manual de instrucciones antes de comenzar la instalación ya que contiene información y consejos para un montaje más sencillo y agradable.

Instrucciones de instalación

Antes de iniciar la instalación, asegúrese de leer cuidadosamente las instrucciones y siga los pasos de instalación uno por uno para terminar con éxito.

Selección de la ubicación de instalación

Recomendamos la instalación sobre una zona nivelada con buen drenaje. La caseta metálica debe anclarse para evitar percances derivados de la acción del viento. El kit no incluye la base por lo que deberá adquirirla por separado o construir la cimentación o el sistema de anclaje por sus propios medios. Para la cimentación es necesario construir una base cuadrada y nivelada. No se recomienda usar la caseta en sitios de costa.

Lista de piezas y accesorios

Por favor verifique y revise la integridad de los componentes necesarios de acuerdo con la lista de partes (despegue la película protectora de plástico antes de ensamblar las piezas, y si es necesario, note y conserve el número de etiqueta): Herramientas necesarias (ver la figura):

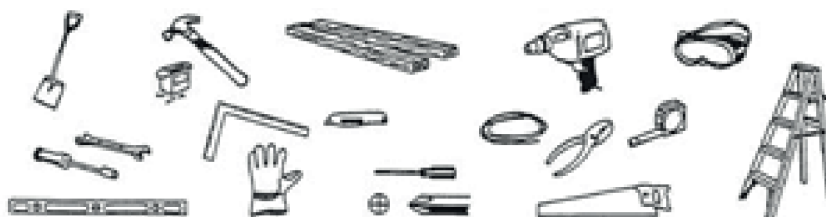

Por favor preste atención a la seguridad al utilizar las herramientas.

Precauciones

1. Se realiza la instalación en días secos y sin viento. Se necesitan dos o más personas trabajando en equipo para completar la instalación de este cuarto de almacenamiento.
2. Use guantes de seguridad, gafas y ropa de manga larga para instalar con el fin de evitar daños teniendo en cuenta que algunas partes pueden ser cortantes.
3. Se prohíbe la entrada de los niños y mascotas en el sitio de construcción.
4. Se prohíbe concentrar el peso del cuerpo en el techo. Cuando se utilicen la escalera u otras herramientas, asegúrese la operación correcta para garantizar su seguridad.

Mantenimiento

1. Mantenga limpio el interior y exterior del cuarto de almacenamiento y utilice un trapo y agua para limpiar.
2. Para garantizar que la puerta pueda deslizarse suavemente, mantenga limpio el carril de la puerta y limpie a tiempo los residuos y basuras.
3. En caso de leves o fuertes nevadas existe riesgo de derrumbe. Límpiela con las herramientas necesarias y asegúrese que es seguro entrar en el interior.
4. El presente cuarto de almacenamiento está destinado solamente a almacenar objetos, y se prohíben la residencia u otros efectos.

Owner's Manual

Please check local building codes regarding footings, location and other requirements before beginning construction. Study and understand this owner's manual of important information and helpful tips for easier and more enjoyable assembly.

Assembly instructions

Reviewing all instructions and the appropriate information before you begin, make sure following the step sequence carefully for successful results.

Flooring base

Your storage building must be anchored to prevent wind damage and Abased may necessary to construct a square and level building. The base is not included in the kit which may need purchase separately or may construct a foundation and anchoring system of your own. A good location for the storage building is a level area with good drainage.

Parts and Parts List

Check to be sure that you have all the necessary parts for your building. Tools you need: (Please tear off the safety protection layer before the assembly, keep the part number label if needed)



Safety must be put in the No. 1 position

Precautions

1. Select a dry and calm day for your assembly. Team works (Two or more people) are required during the assembly.
2. Wearing safety gloves, eye protection and long sleeves during the assembly to prevent injury; Pay attention to the sharp edge of some parts.
3. Children and pets are not allowed entering into the construction site.
4. Never concentrate your total weight on the roof of the building. When using a step ladder make sure that it is safety.

Care & Maintenance

1. Keep the shed clean with soft cloth, use water if necessary.
2. Keep the door tracks clear of dirt and other stuff that prevent them from sliding easily.
3. Clean the snow with necessary tools to make sure it is safe to enter into. Heavy snow may cause collapse, please make sure safety before entering into.
4. The shed is not made for living but storing stuff.

Notice De Montage

Avant de commencer le montage, merci de vérifier auprès de votre mairie les contraintes liées à votre commune en matière d'implantation d'abris de jardin. Veuillez aussi lire entièrement et attentivement cette notice avant de commencer le montage de votre abri.

Lieu de montage de votre abri et dalle béton

Choisir un endroit protégé des vents violents. Votre abri devra obligatoirement être fixé sur une dalle béton que vous aurez préalablement réalisée. Celle dalle béton devra être parfaitement plane. A noter que cet abri n'inclut pas de plancher ni kit d'ancrage.

Inventaire

Faites l'inventaire des pièces présentées ci-dessous. Vérifiez que tous les éléments sont bien présents avant de commencer le montage.

Supprimer le film de protection avant le montage.

Outillage nécessaire

Voire les éléments présentés sur le visual ci-dessous. Veuillez faire attention à la sécurité lors de l'utilisation de ces outils.



Consignes à observer pour le montage

1. Privilégiez un endroit protégé des vents violents.
2. 2 personnes sont nécessaires pour le montage.
3. Eloignez les enfants et animaux domestiques. Pour éviter toute blessure, portez des gants de sécurité, des lunettes protectrices et mettez des vêtements à manches longues. Attention particulièrement aux angles vifs des éléments.
4. Ne pas monter sur le toit.

Maintenance et entretien

1. Entretien à l'eau et au savon.
2. Afin d'assurer le bon coulisement de la porte, veuillez garder le rail de porte propre.
3. L'accumulation de neige peut entraîner l'effondrement du toit. Veuillez donc à retirer régulièrement la neige qui se sera accumulée sur le toit.
4. Cet abri est uniquement réservé à l'usage de stockage. Il ne peut servir comme pièce d'habitation ou autre usage en dehors de celui de stockage.

Manual do Usuário

Por favor, consulte as regras relativas à construção, localização e outras exigências antes de instalar a sua casota do metal. Leia este manual antes de iniciar a instalação, pois ele contém informações e dicas para montagem mais simples e agradáveis

Instruções de instalação

Antes de iniciar a instalação, certifique-se que leu atentamente as instruções e siga as etapas de instalação, uma por uma para concluir a instalação com êxito..

Selecionar o local de instalação

Recomendamos a instalação numo área nivelado com boa drenagem. A casota de metal deve ser ancorado e pureza amo cao para evitar acidentes resultantes do vento.

O kit não inclui a base pelo que você deverá compra-la separadamente su, construir uma base ou sistema de ancoragem por conta própria. Para a base é necessário uma base quadrada e nívelada com boa drenagem.

Peças e acessórios

Por favor consulte e verifique o estado dos componentes necessários de acordo com a lista de peças (a partir da película de plástico de protecção antes da montagem das peças, e, se necessário, registre o numero da peça): Ferramentas necessárias (ver figura):

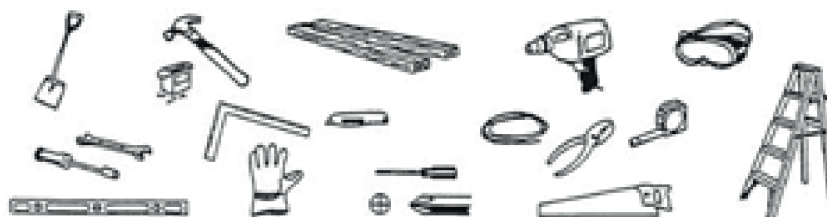

Por favor, de atenção à segurança año utilizar as ferramentas.

Precauções



1. A instalação debe ser feita em dias secos e sem vento. São necessarias duas ou mais pessoas trabalhando juntas para concluir a instalação desta casota de armazenamento
2. Use luvas de segurança, óculos e roupas largas para instalar, a fim de evitar danos considerando que algumas partes poderão estar afiadas e cortar.
3. Deverá ser proibida o acesso de crianças e animais de estimação no local de construção.
4. Não deverá concentrar o seu peso no telhado. Quando uma escada ou outras ferramentas forem utilizadas, favor de assegurar o funcionamento correto das mesmas, de modo a garantir a sua segurança.

Manutenção

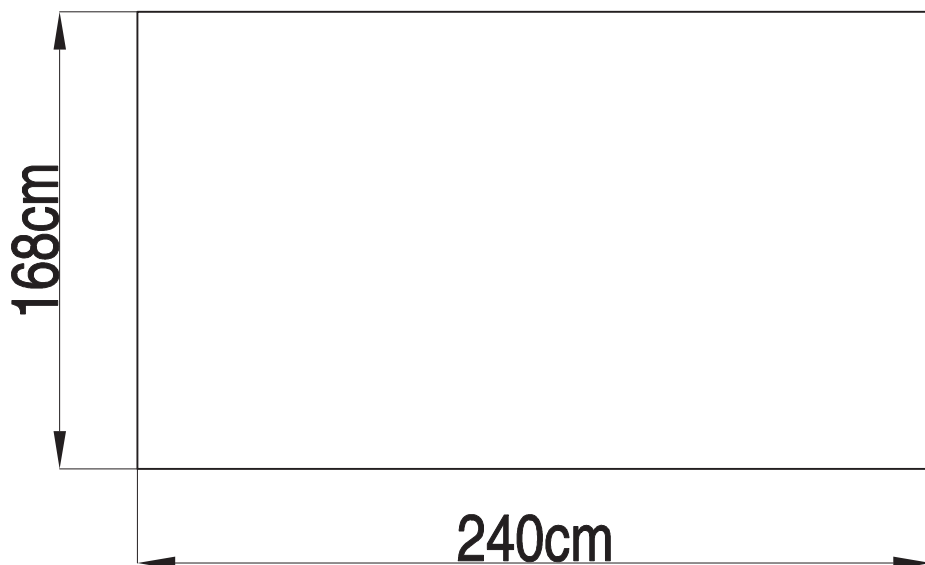
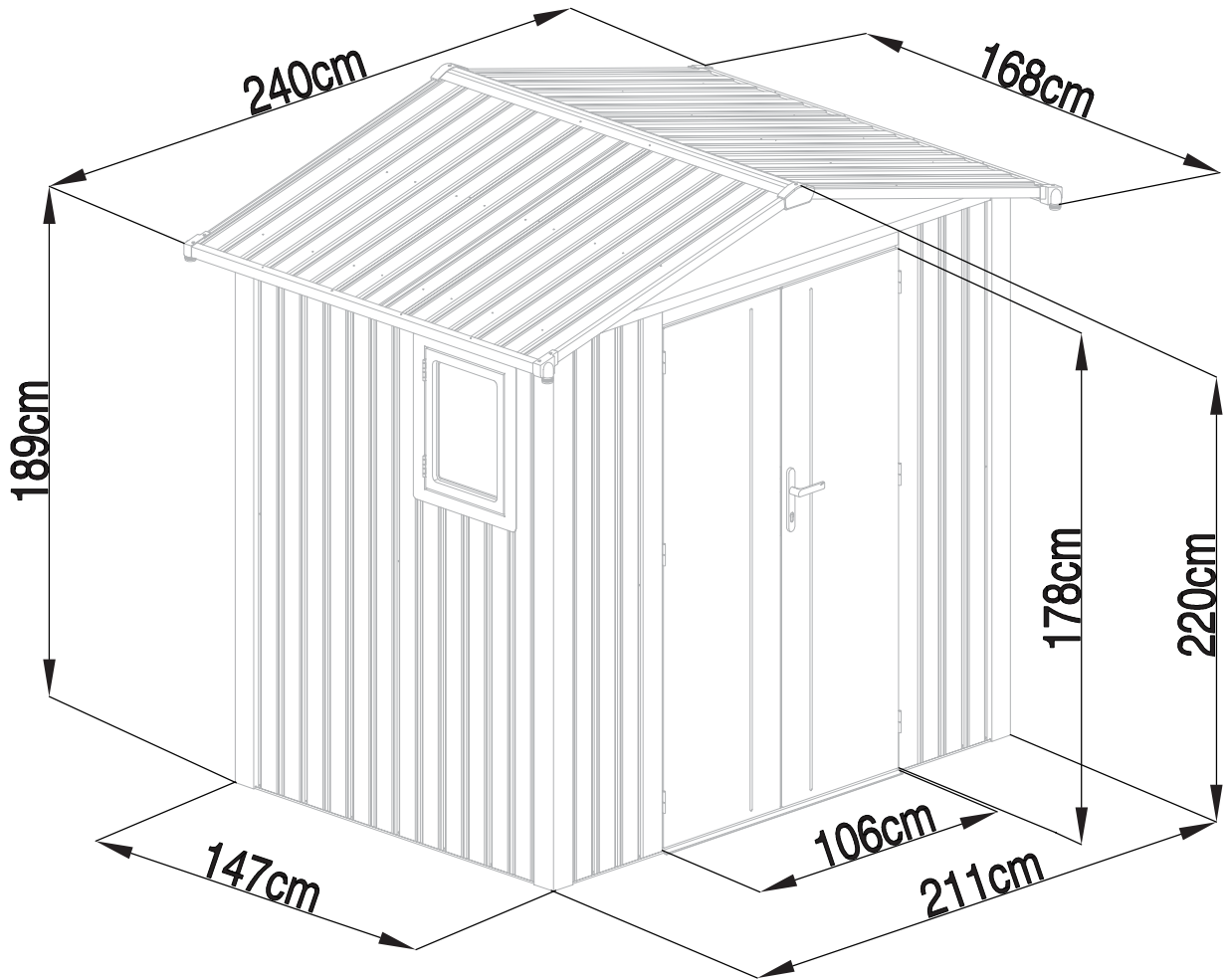

1. Manter limpa o interior e exterior da casota de armazenamento e utilizar um pano com água para limpar.
2. Para garantir que a porta possa deslizar suavemente, manter limpa a pista da porta e perder algum tempo a limpar os residuos.
3. Em caso de neve leve ou pesada pode existe um risco de colapso. Limpe e remova a neve com as ferramentas necessárias e certifique-se que é seguro para ir a dentro.
4. Esta arrecadação é destinada apenas para armazenar objetos e mutras utilizadores devem ser proibidas.

KIS12100

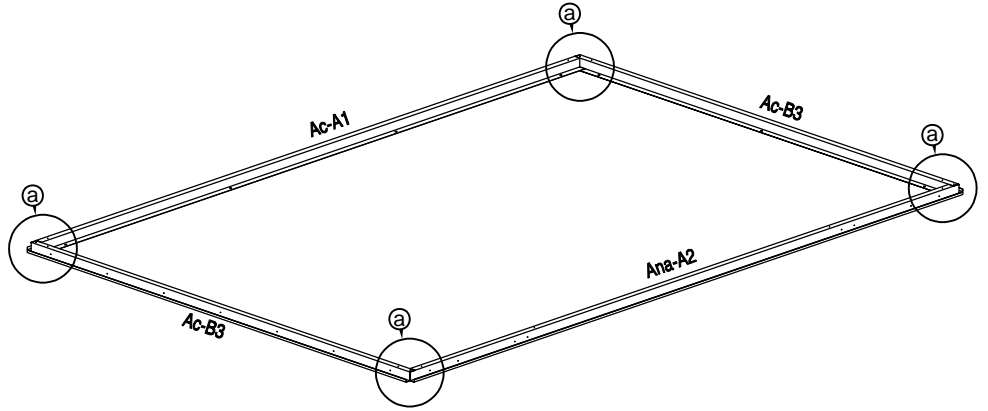
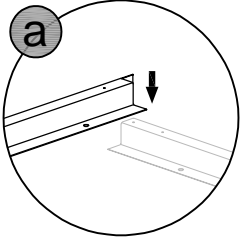

1	 Ac-A1 x1	 Ana-A2 x1	 Ac-B3 x2	
----------	---	--	---	--

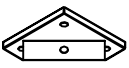



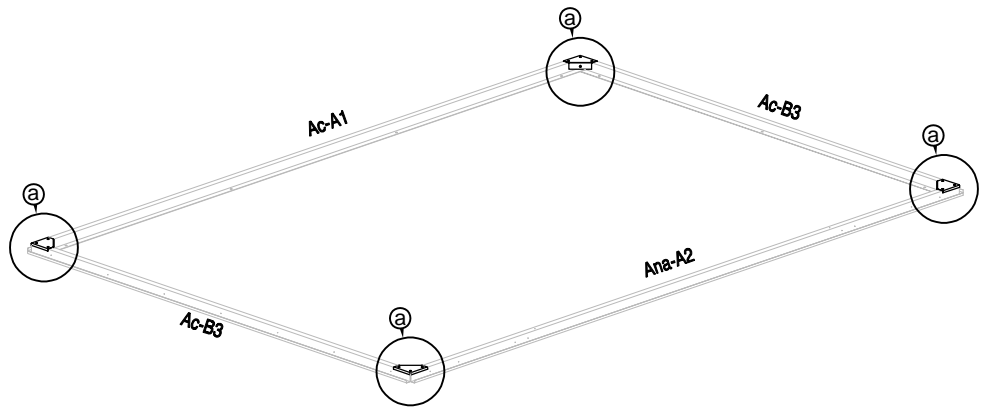
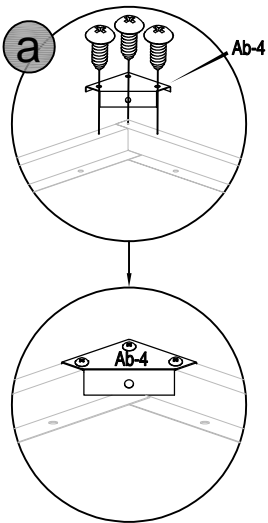

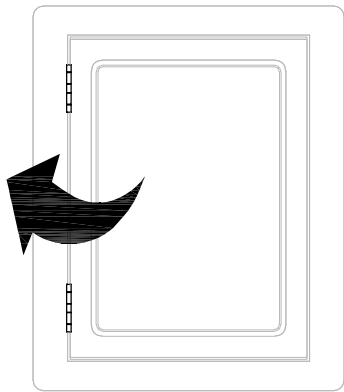
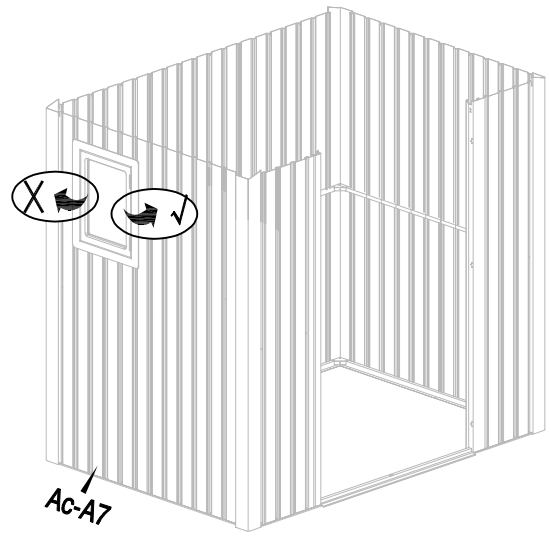
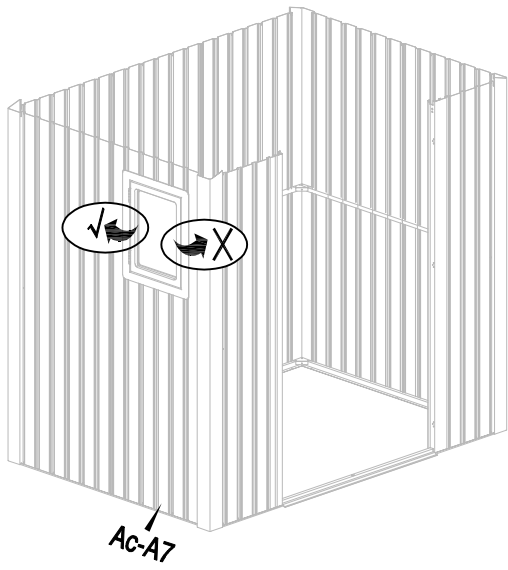

2	 Ab-4 x4	 Anj-A41 x12	
----------	--	--	--

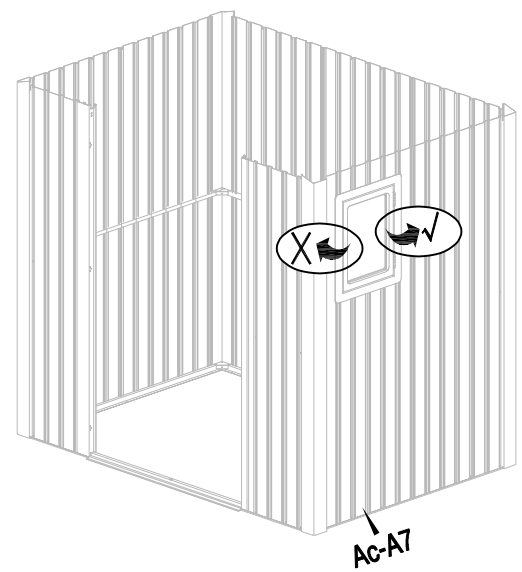
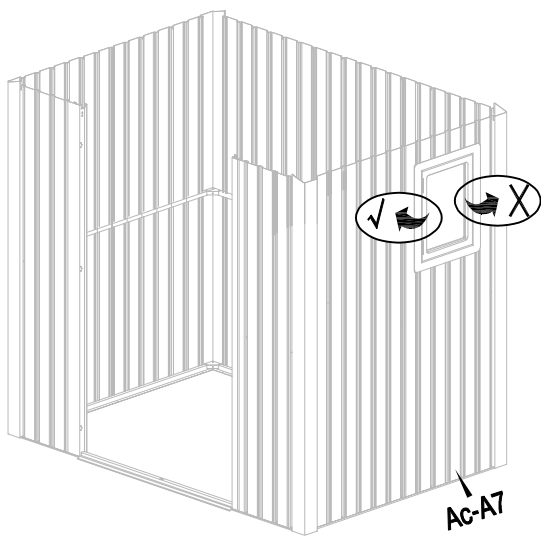
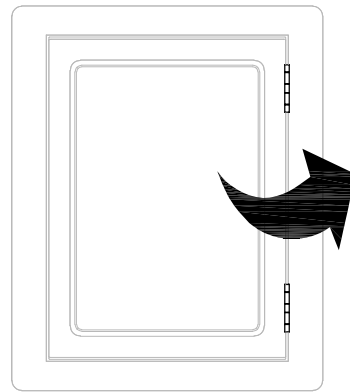







Or

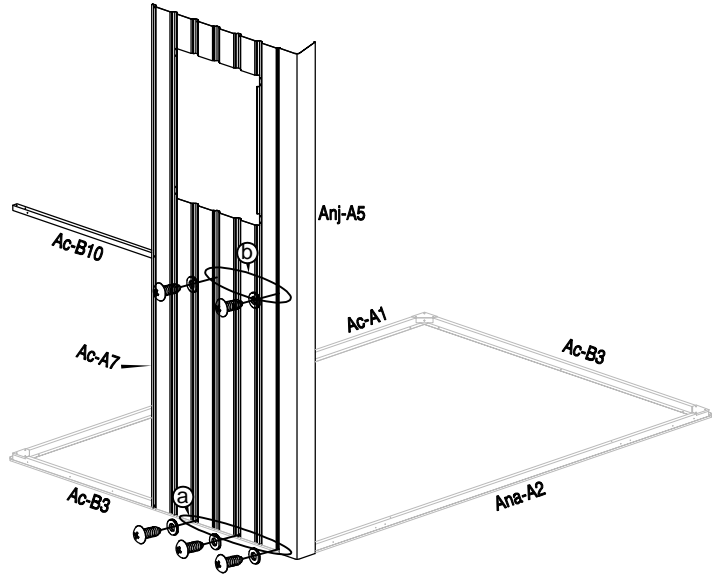
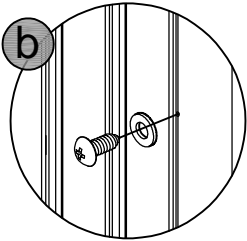
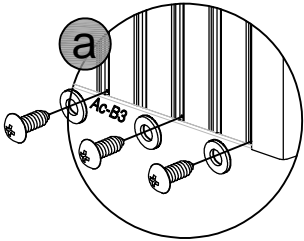
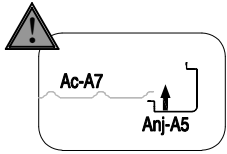

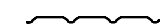



3	 Ac-A7 x1	 Anj-A5 x1	 Ac-B10 x1	 Anj-A41 x5	 Anj-A40 x5	
---	---	--	--	--	---	--

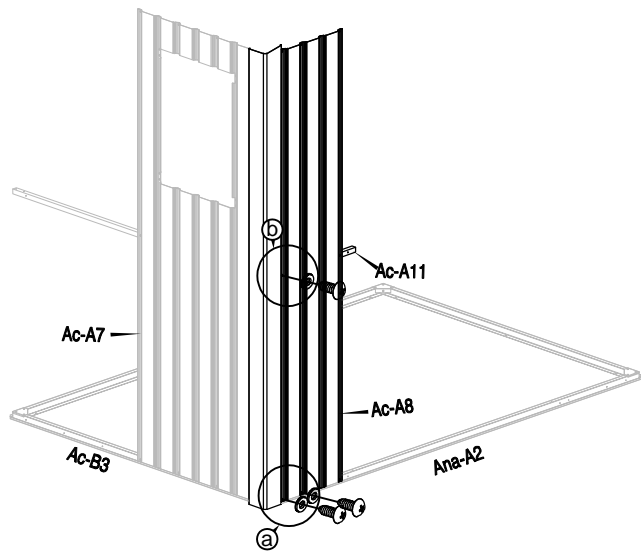
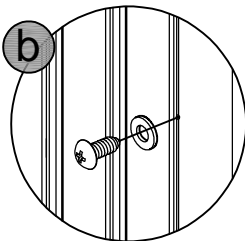
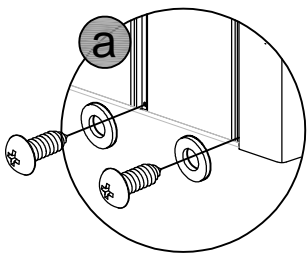





4	 Ac-A8 x1	 Ac-A11 x1	 Anj-A41 x3	 Anj-A40 x3	
---	---	--	---	--	--

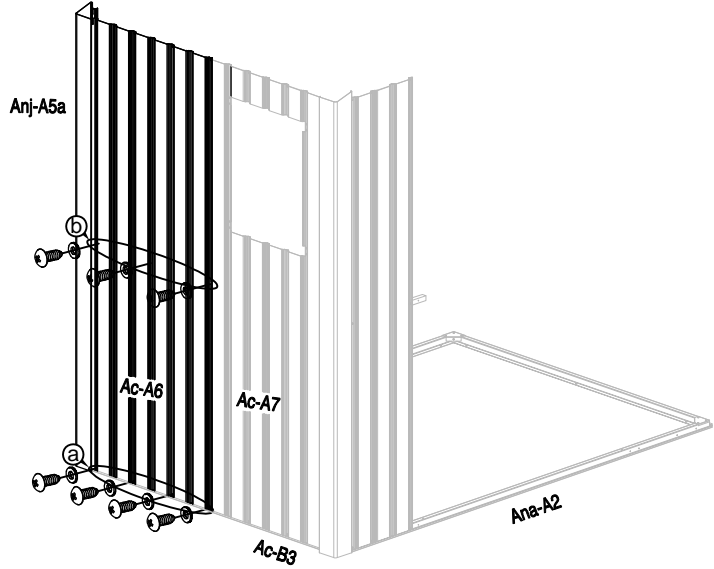
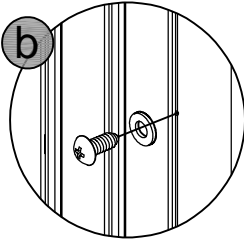
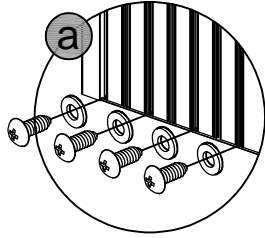



5	 Ac-A6 x1	 Anj-A5a x1	 Anj-A41 x7	 Anj-A40 x7	
---	---	---	---	--	--



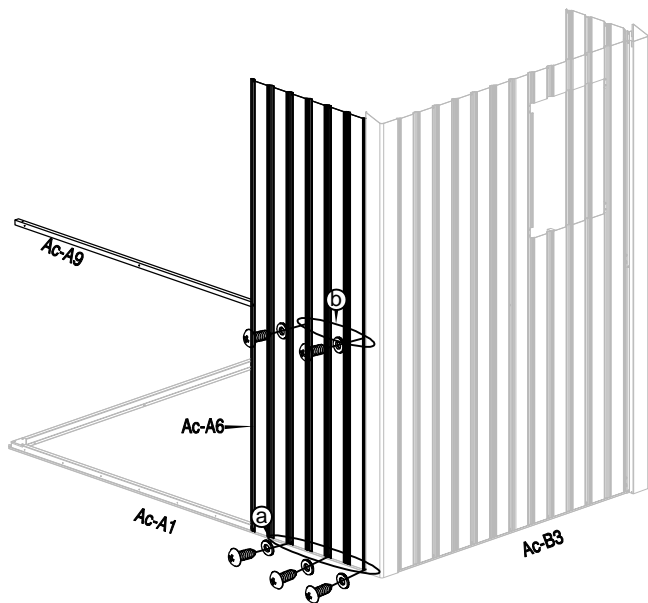
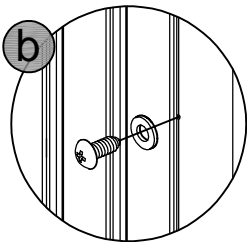
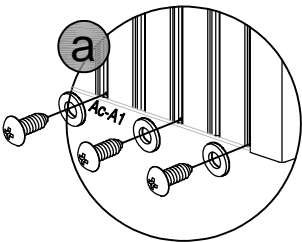



6	 Ac-A6 x1	 Ac-A9 x1	 Anj-A41 x5	 Anj-A40 x5	
---	---	---	---	--	--

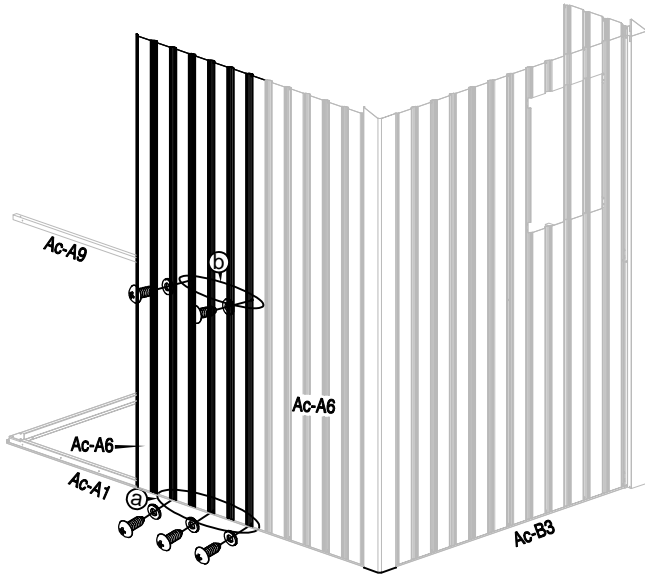
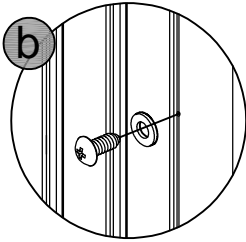
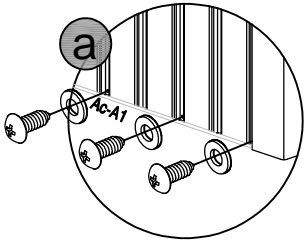





7	 Ac-A6 x1	 Anj-A41 x5	 Anj-A40 x5	
---	---	---	---	--

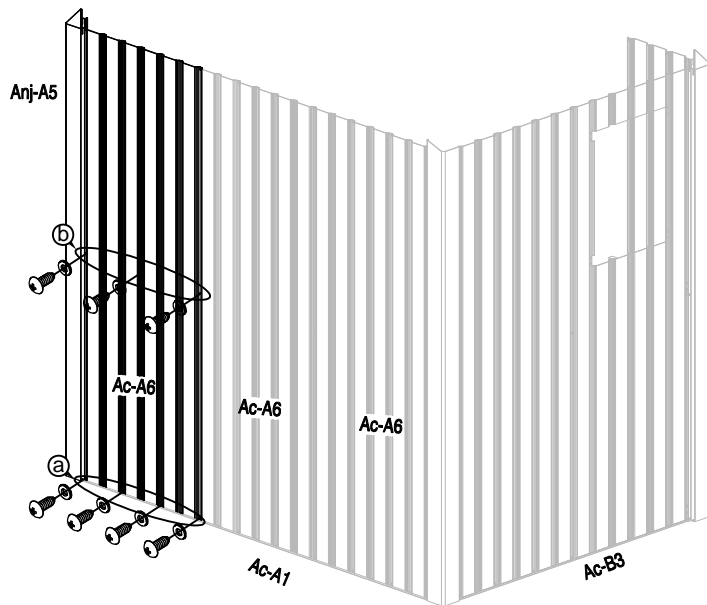
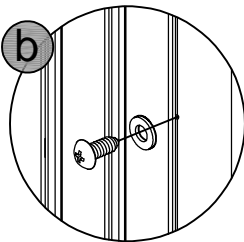
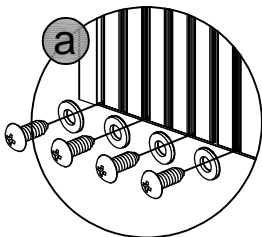





8	 Ac-A6 x1	 Anj-A5 x1	 Anj-A41 x7	 Anj-A40 x7	
---	---	--	---	--	--

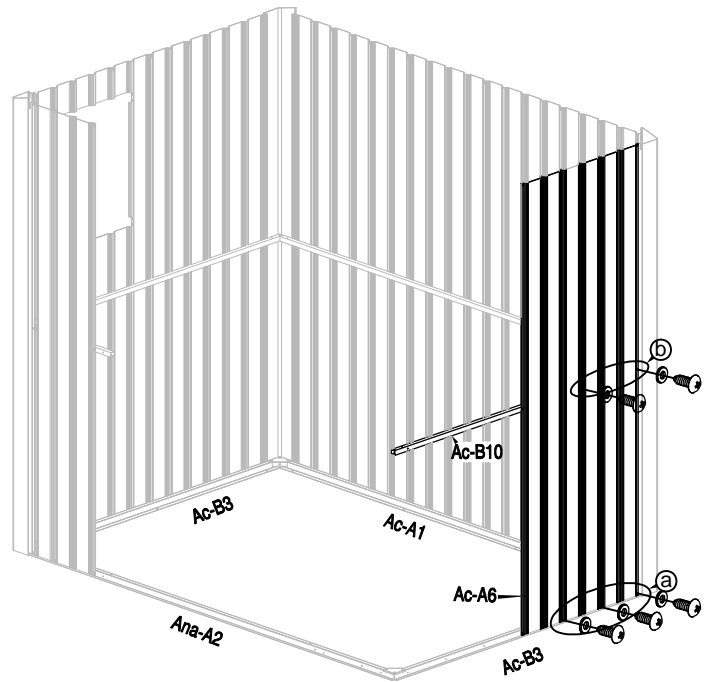
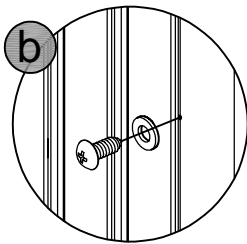
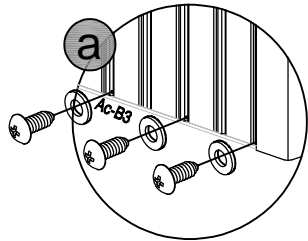





9	 Ac-A6 x1	 Ac-B10 x1	 Anj-A41 x5	 Anj-A40 x5	
---	---	--	---	--	--

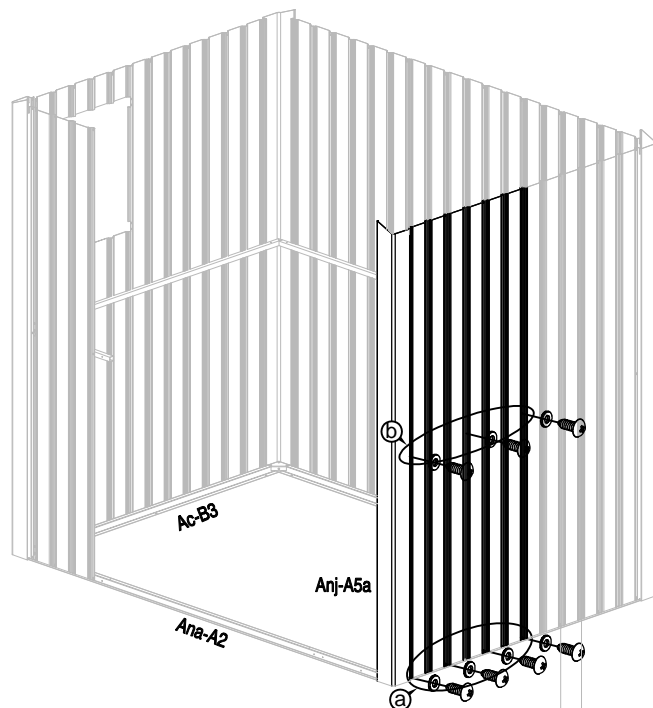
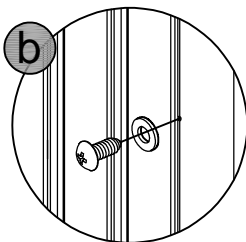
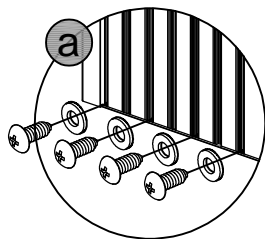



10	 Ac-A6 x1	 Anj-A5a x1	 Anj-A41 x7	 Anj-A40 x7	
----	---	---	---	--	--



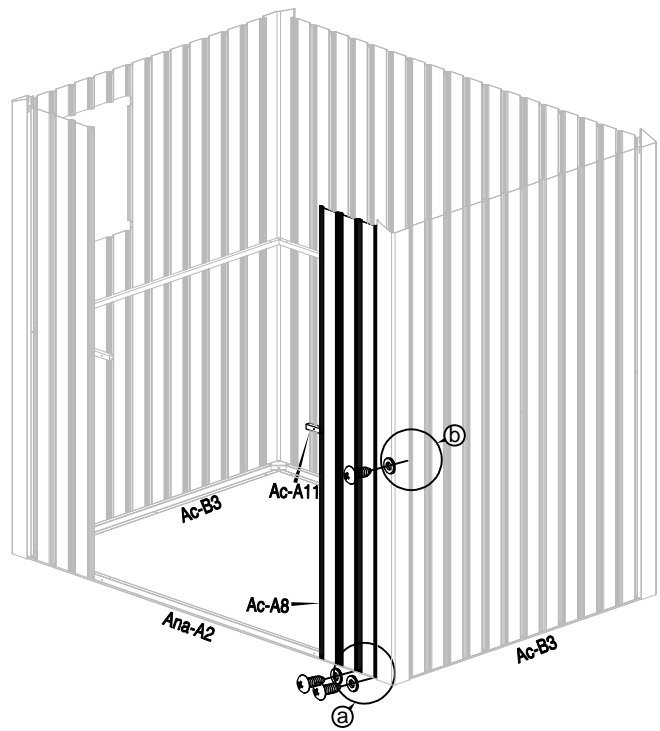
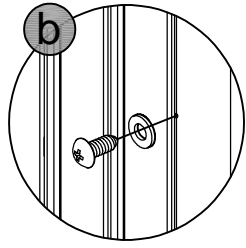
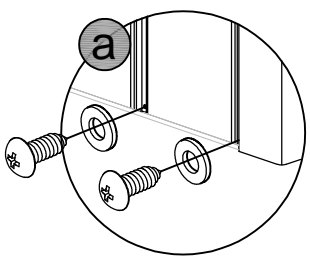

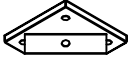

11	 Ac-A8 x1	 Ac-A11 x1	 Anj-A41 x3	 Anj-A40 x3	
----	---	--	---	--	--

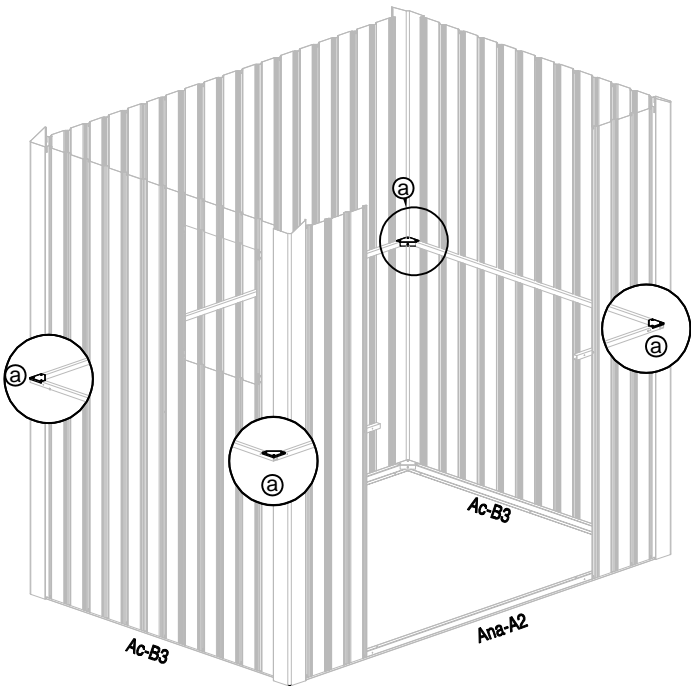
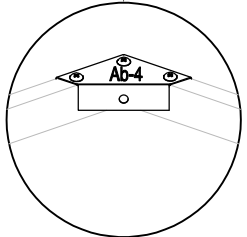
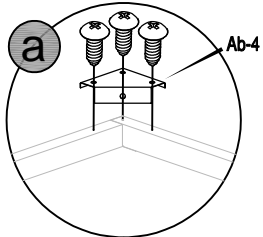





12	 Ab-4 x4	 Anj-A41 x12	
----	--	--	--

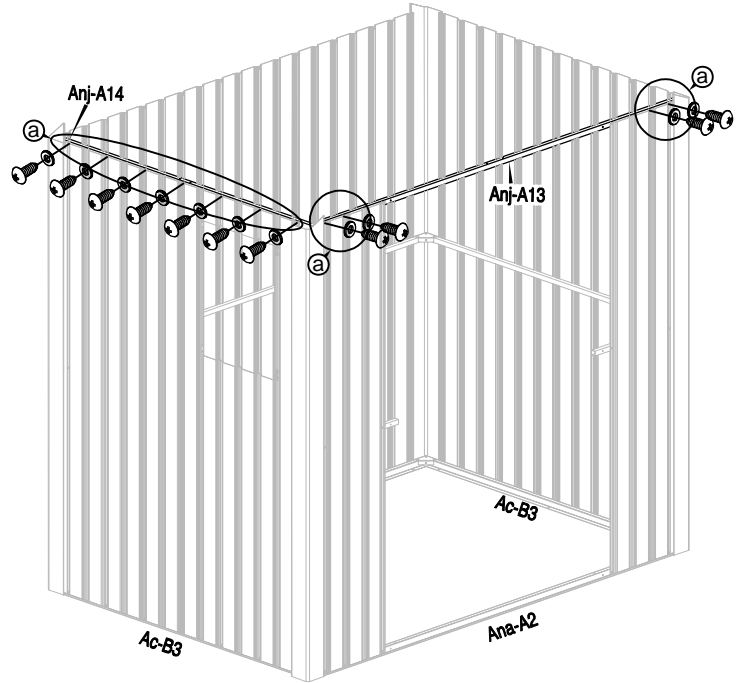
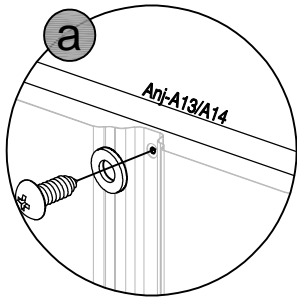
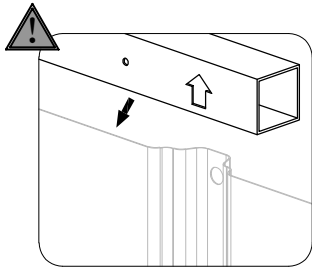

13	 Anj-A13 x1	 Anj-A14 x1	 Anj-A41 x11	 Anj-A40 x11	
----	---	---	--	---	--



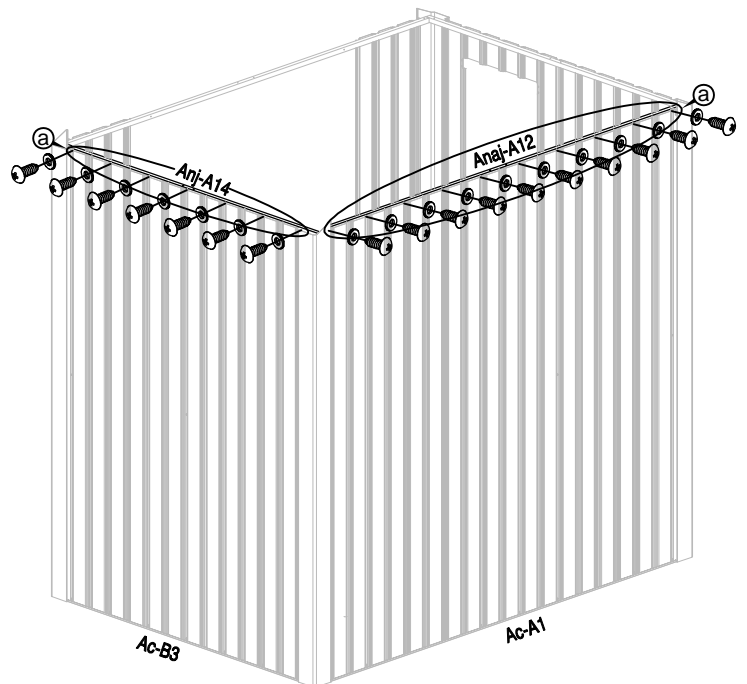
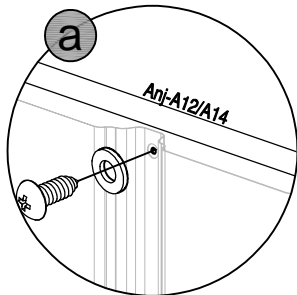
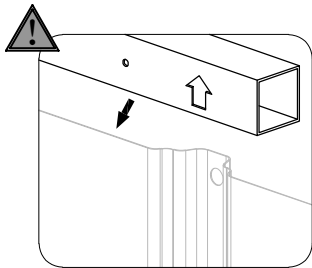

14	 Anj-A12 x1	 Anj-A14 x1	 Anj-A41 x17	 Anj-A40 x17	
----	---	---	--	---	--



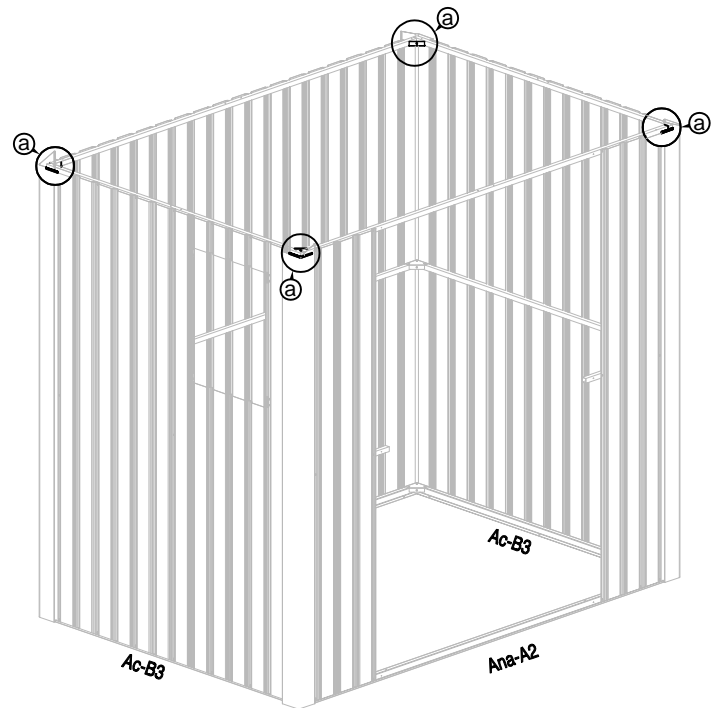
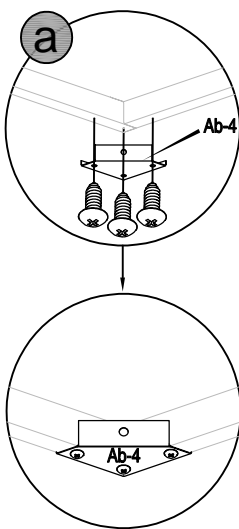

<p>15</p>	 <p>Ab-4 x4</p>	 <p>Anj-A41 x12</p>	
------------------	--	--	--



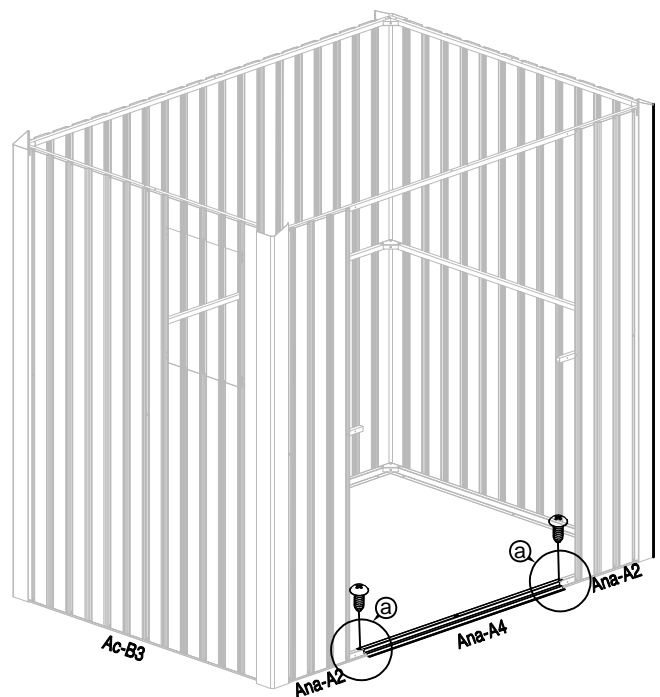
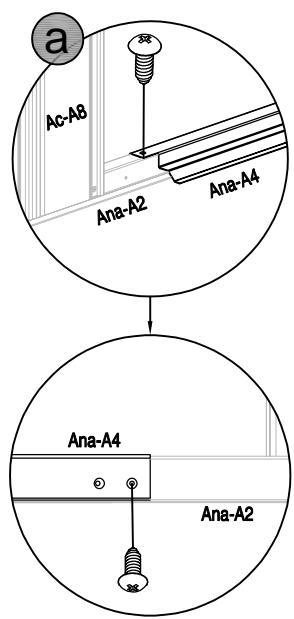
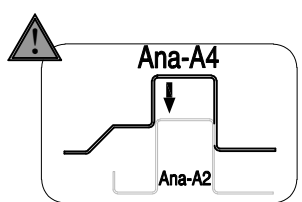



<p>16</p>	 <p>Ana-A4 x1</p>	 <p>Anj-A41 x4</p>	
------------------	--	---	--

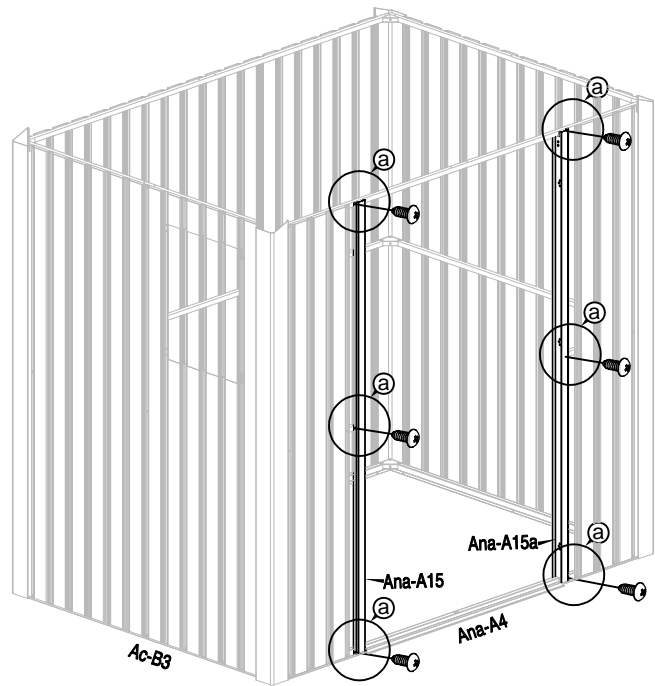
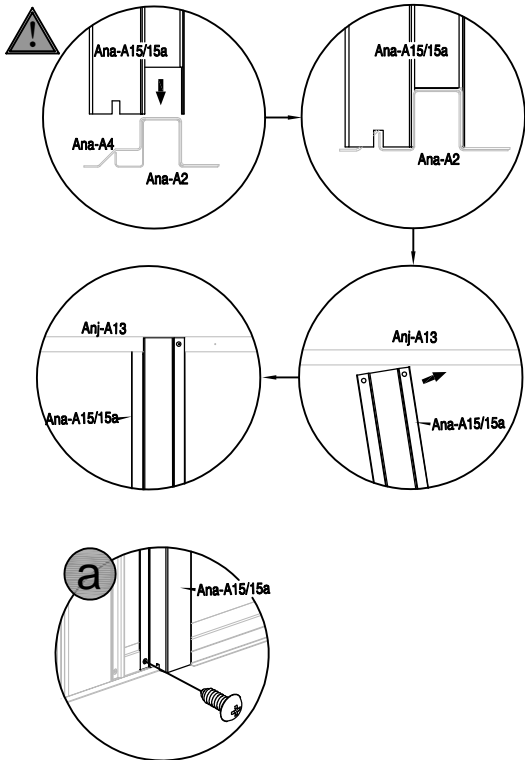



17	 Ana-A15 x1	 Ana-A15a x1	 Anj-A41 x6	
----	---	--	---	--

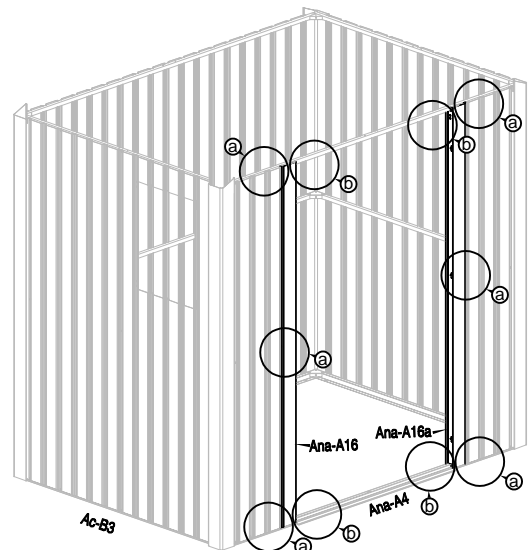
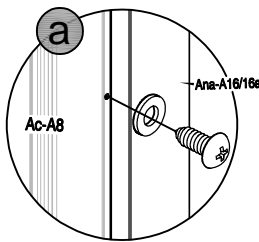
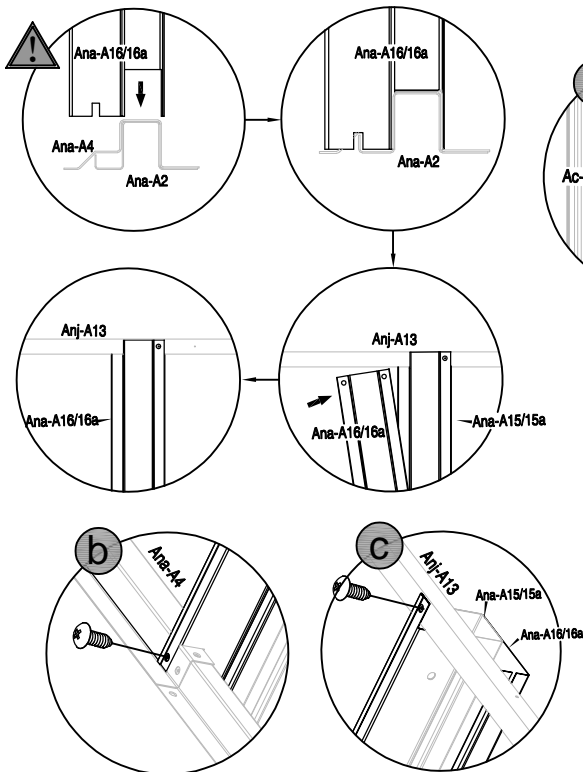

18	 Ana-A16 x1	 Ana-A16a x1	 Anj-A41 x10	 Anj-A40 x6
----	---	--	--	--



<p>19</p>	 <p>Ana-A17 x1</p>	 <p>Anj-A44 x4</p>	
------------------	---	---	--

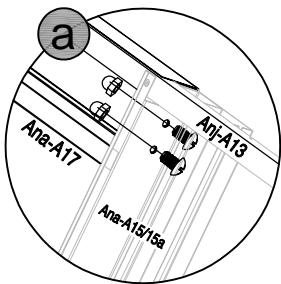
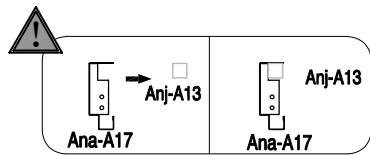

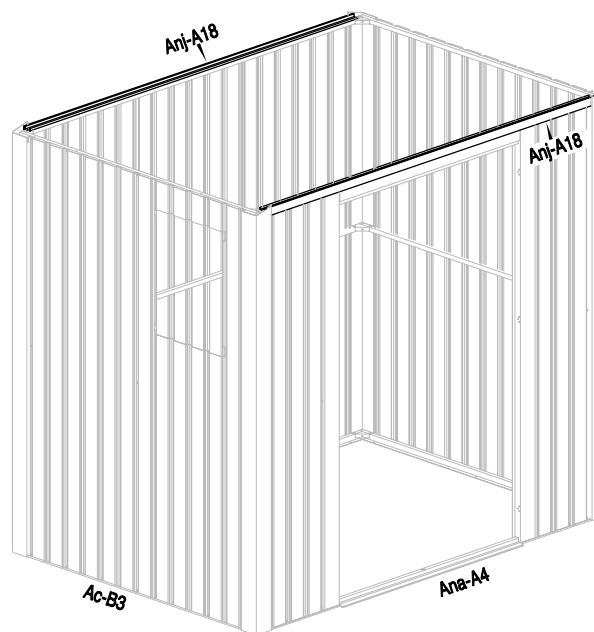
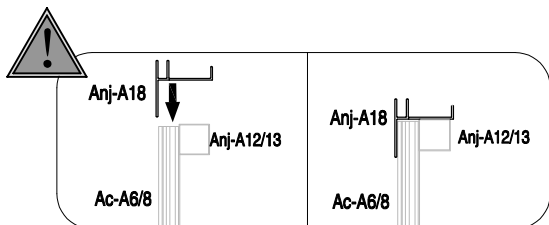

<p>20</p>	 <p>Anj-A18 x2</p>	
------------------	---	--



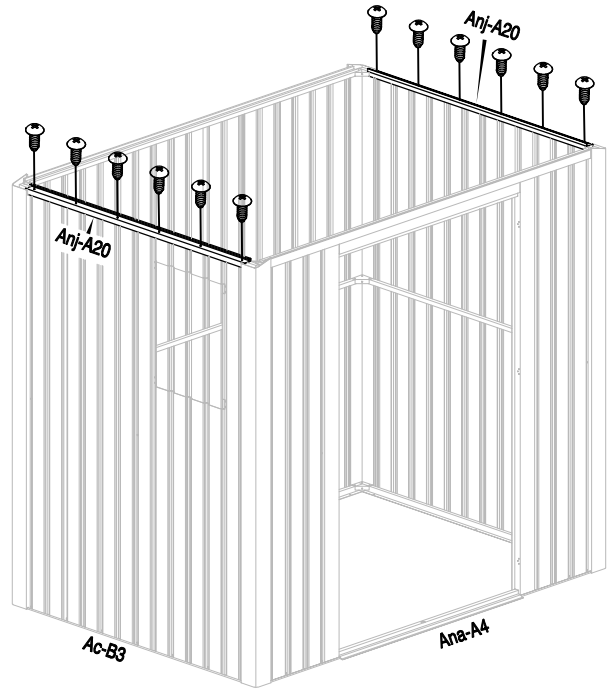
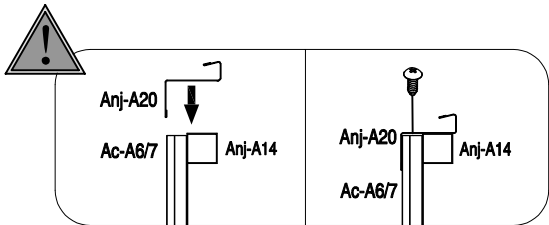



21	 Anj-A20 x2	 Anj-A41 x12	
----	---	--	--

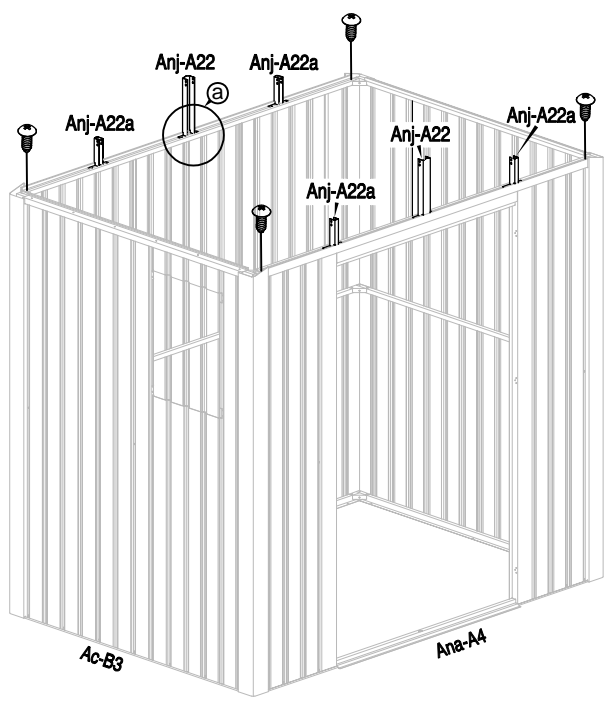
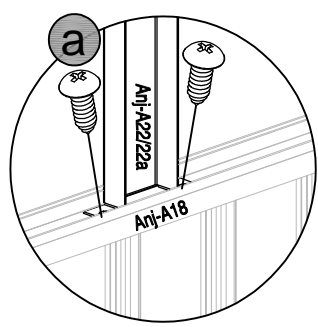

22	 Anj-A22 x2	 Anj-A22a x4	 Anj-A41 x16	
----	---	--	--	--





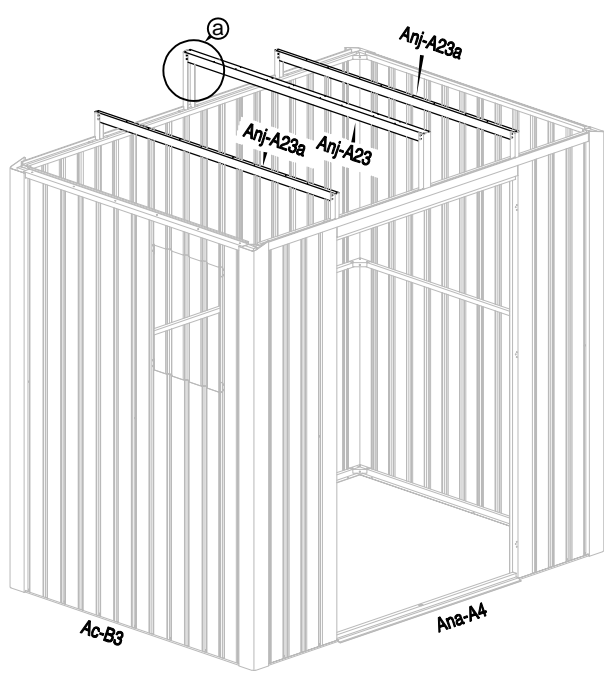
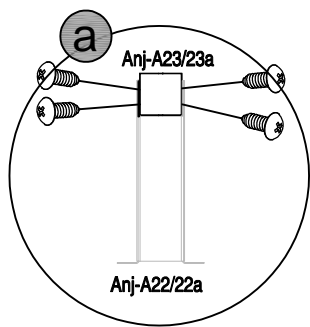
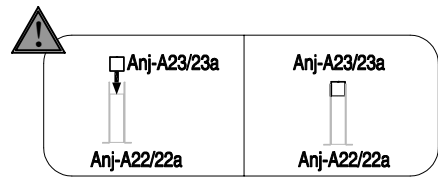

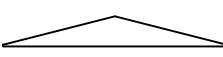
	 <p>Anj-A23 x1</p>	 <p>Anj-A23a x2</p>	 <p>Anj-A41 x24</p>	
--	---	--	--	--

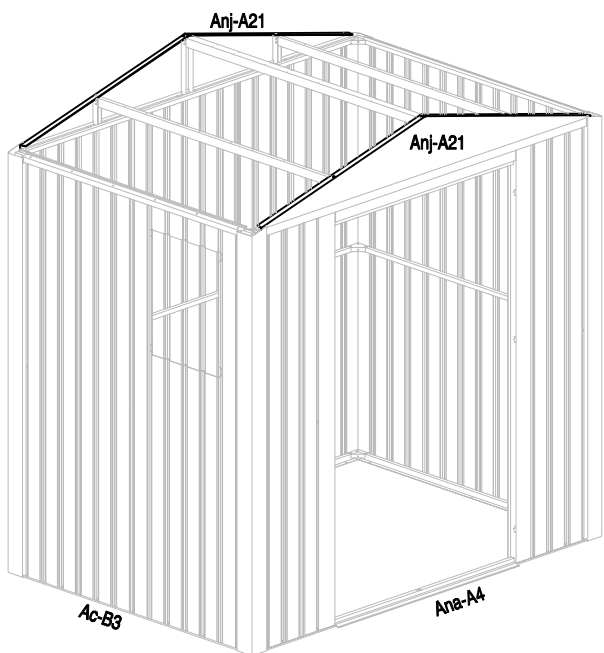
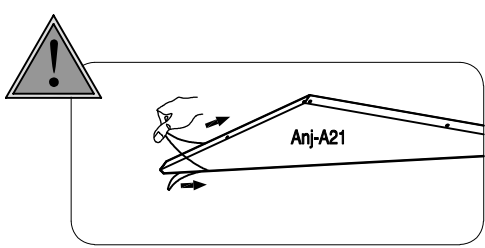



	 <p>Anj-A21 x2</p>	
--	---	--



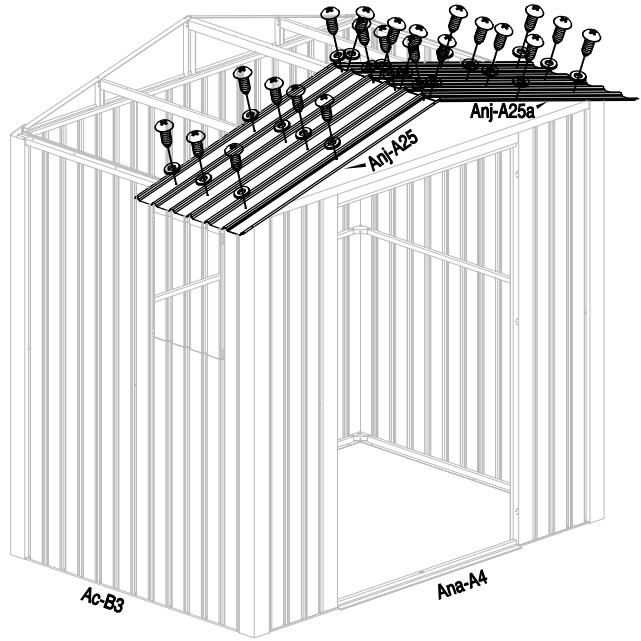
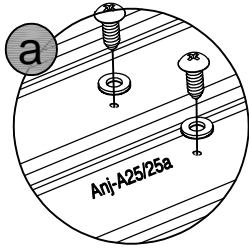



<p>25</p>	 <p>Anj-A25 x1</p>	 <p>Anj-A25a x1</p>	 <p>Anj-A41 x22</p>	 <p>Anj-A40 x22</p>	
-----------	---	--	--	---	--

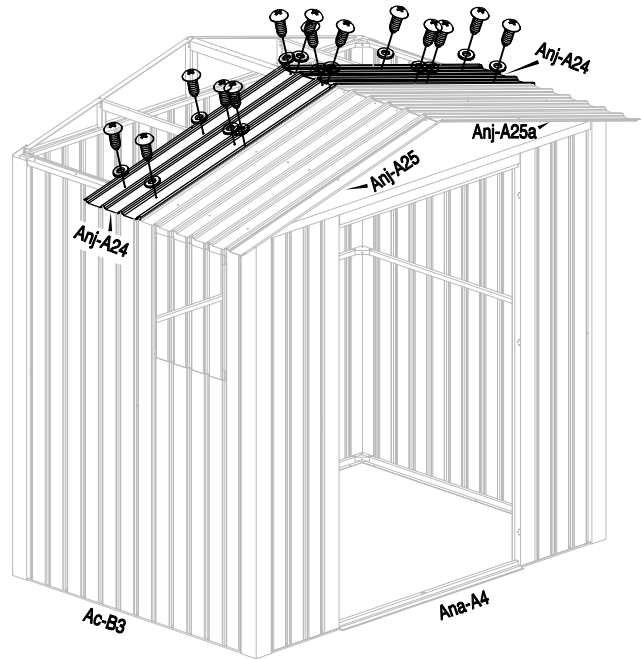
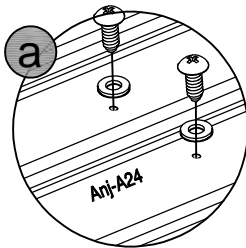



<p>26</p>	 <p>Anj-A24 x2</p>	 <p>Anj-A41 x14</p>	 <p>Anj-A40 x14</p>	
-----------	---	--	--	--



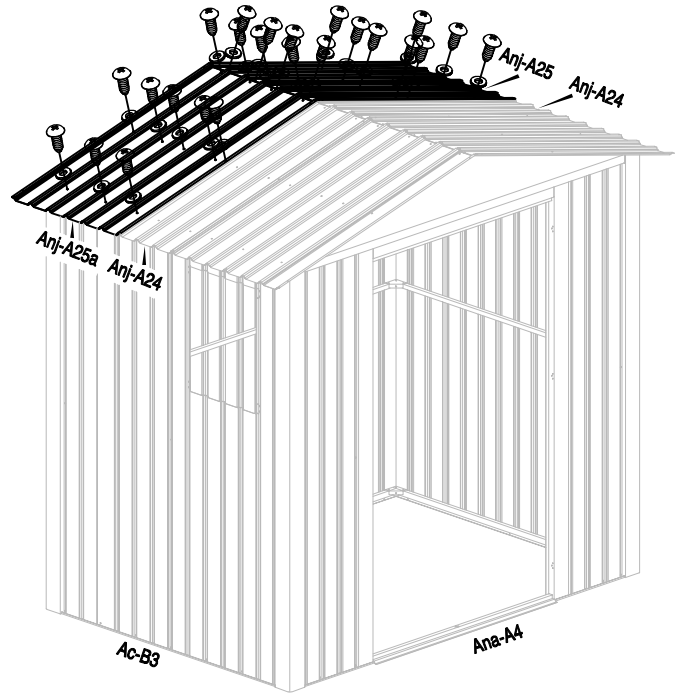
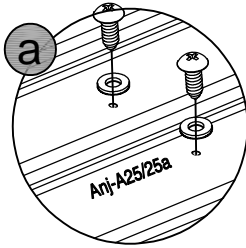
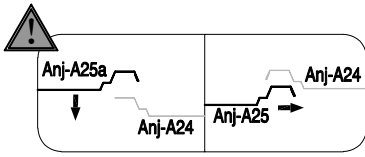

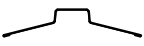

27	 Anj-A25 x1	 Anj-A25a x1	 Anj-A41 x24	 Anj-A40 x24	
----	---	--	--	---	--

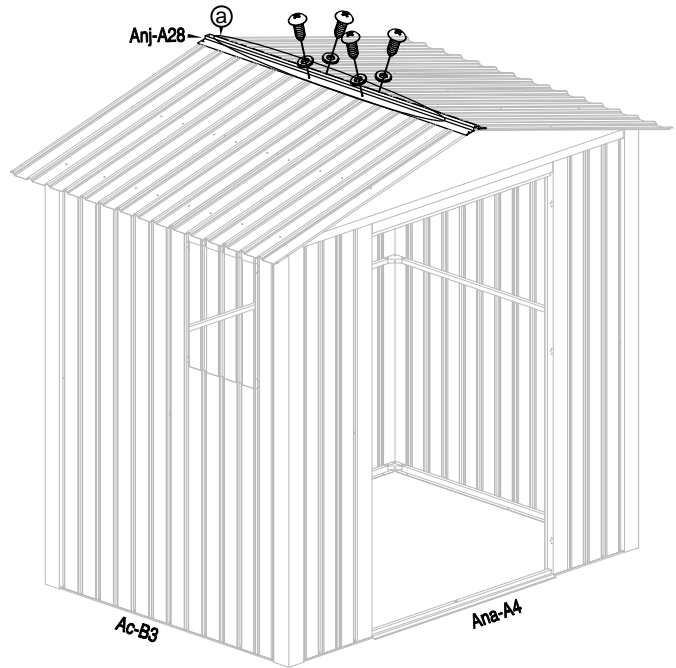
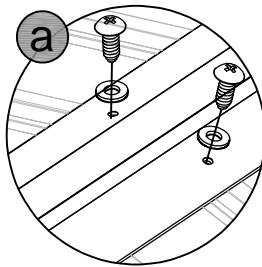

28	 Anj-A28 x1	 Anj-A46 x4	 Anj-A40 x4	
----	---	---	---	--



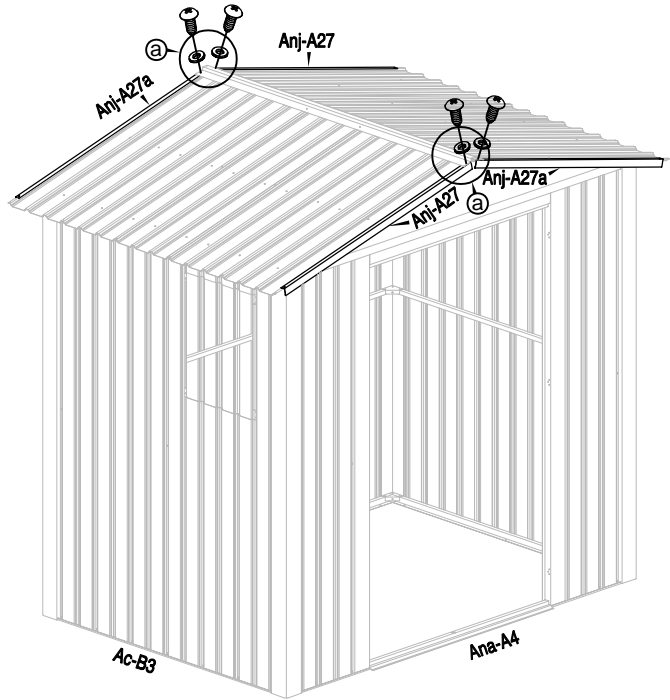
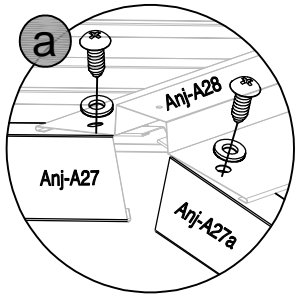

<p>29</p>	 <p>Anj-A27 x2</p>	 <p>Anj-A27a x2</p>	 <p>Anj-A41 x4</p>	 <p>Anj-A40 x4</p>	
-----------	---	--	---	--	--



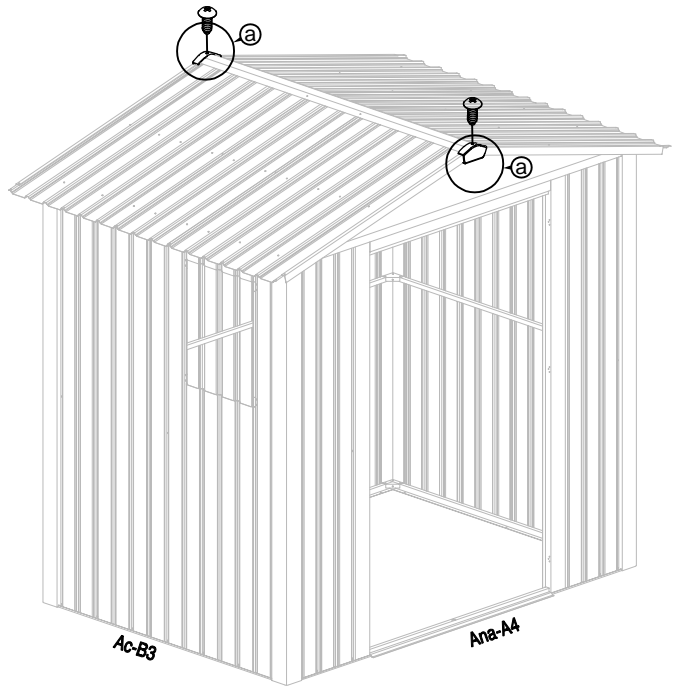
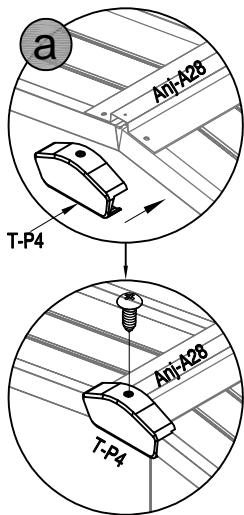

<p>30</p>	 <p>T-P4 x2</p>	 <p>Anj-A41 x2</p>	
-----------	--	---	--

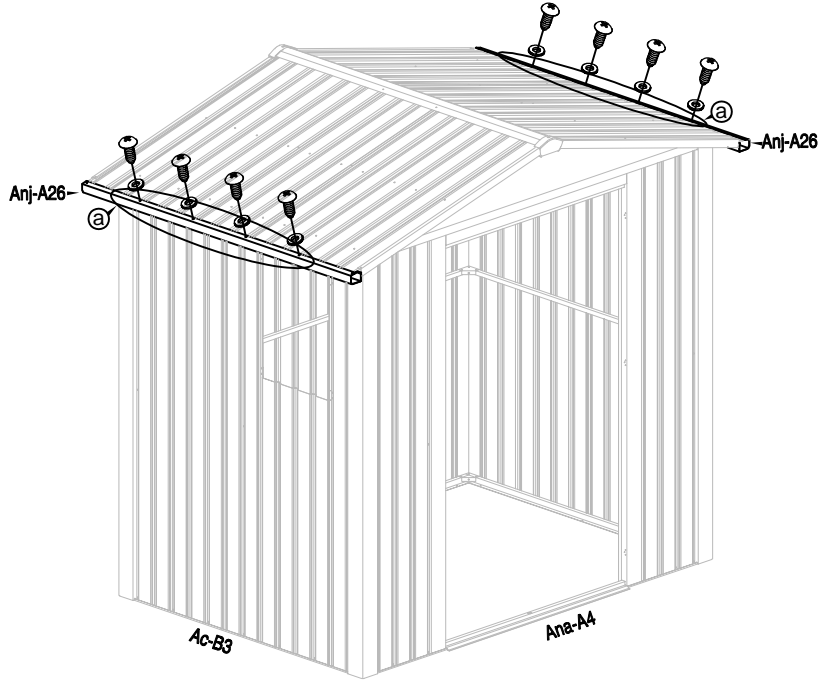
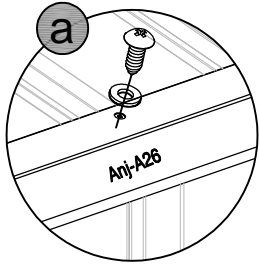
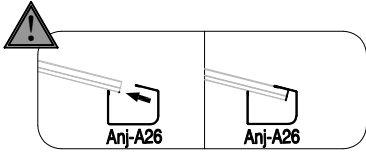

<p>31</p>	 <p>Anj-A26 x2</p>	 <p>Anj-A41 x8</p>	 <p>Anj-A40 x8</p>	
------------------	---	---	---	--





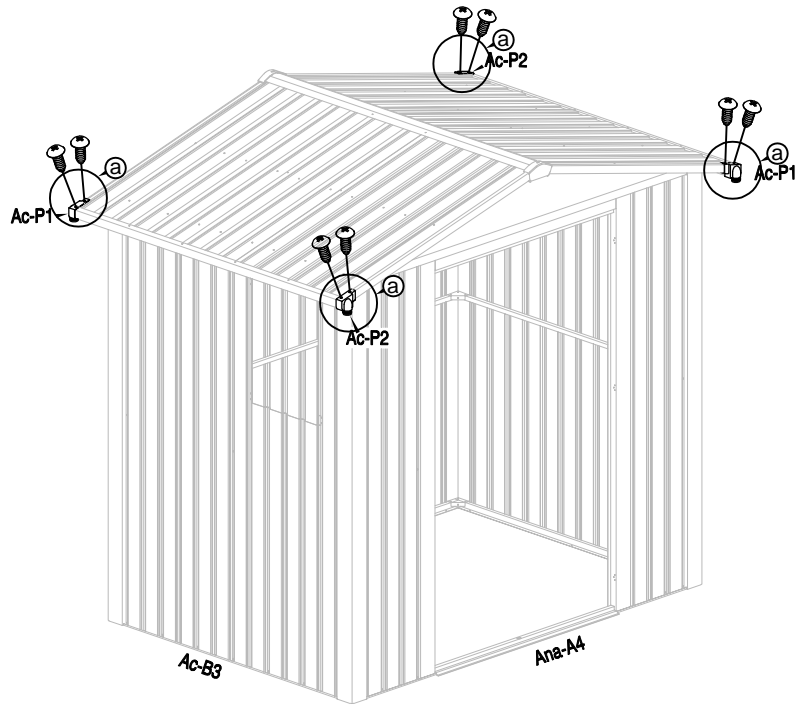
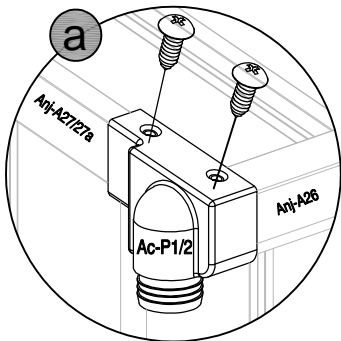
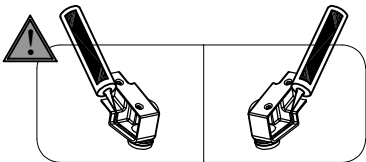

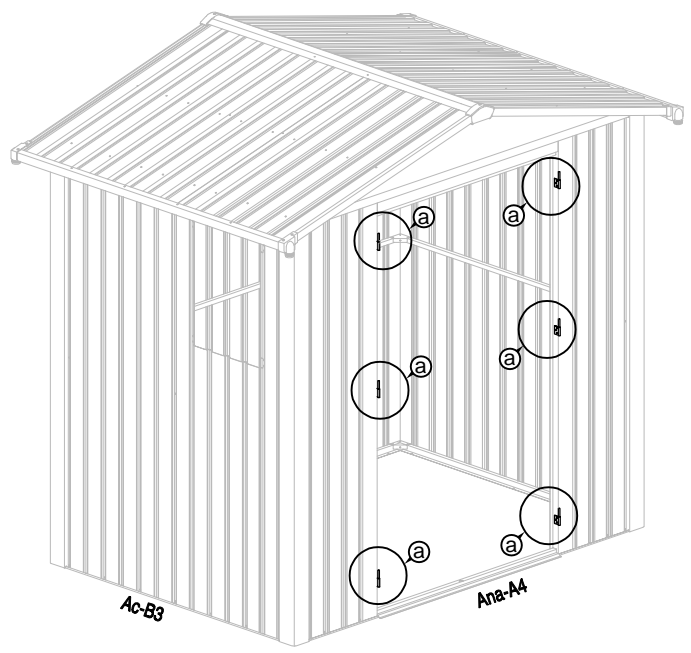
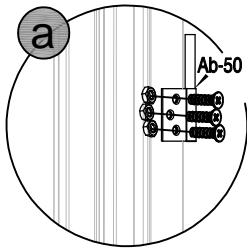

<p>32</p>	 <p>Ac-P1 x2</p>	 <p>Ac-P2 x2</p>	 <p>Anj-A41 x8</p>	
------------------	---	---	---	--



33	 Ab-50 x6	 Anj-A43 x18	
----	---	--	--



34	 Ac-A29 x1	 Ac-A29a x1	 Ana-54 x1	 Ana-55 x1	 Ana-56 x1	 Ana-57 x1	 Ana-58 x3	
----	--	---	--	--	--	--	--	--

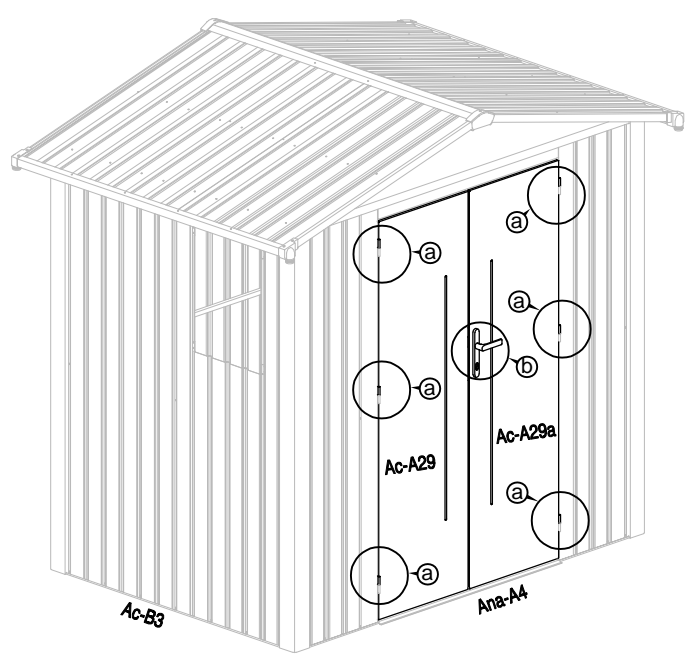
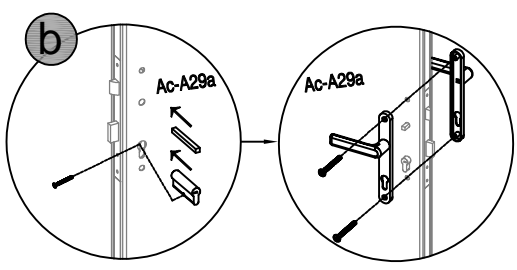
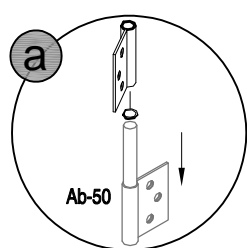

35	 Ana-P6 x1	 Anj-A41 x4	
-----------	--	---	--

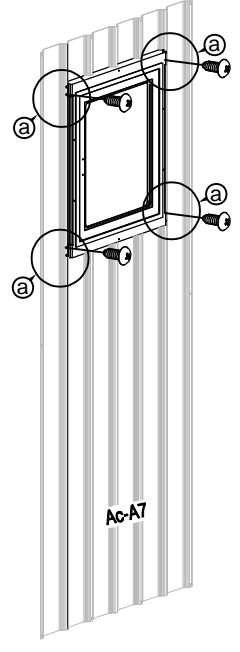
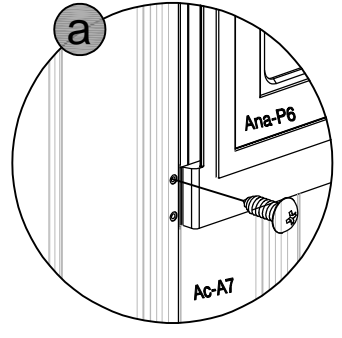
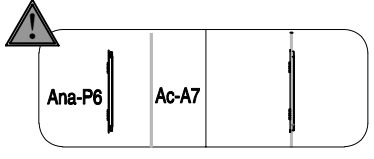

36	 Ana-P7 x1	 Anj-A41 x10	
-----------	--	--	--

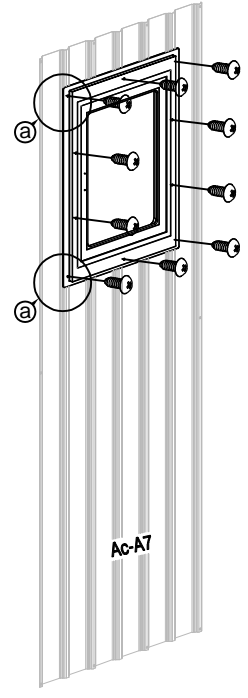
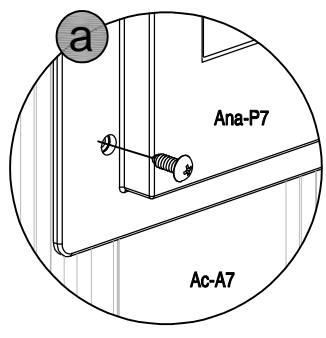
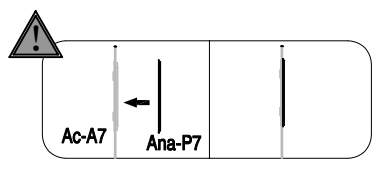

37

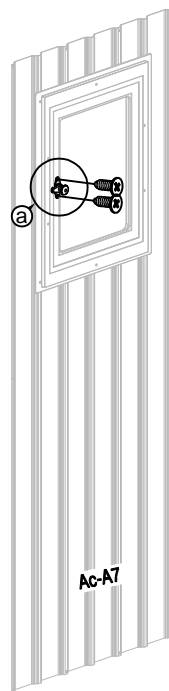
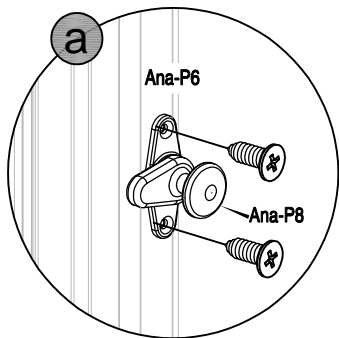
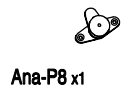

38

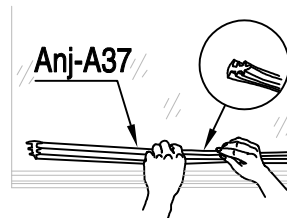
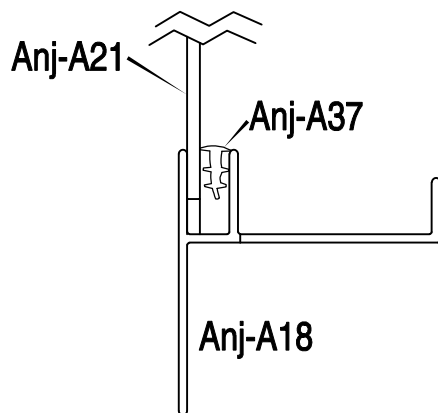

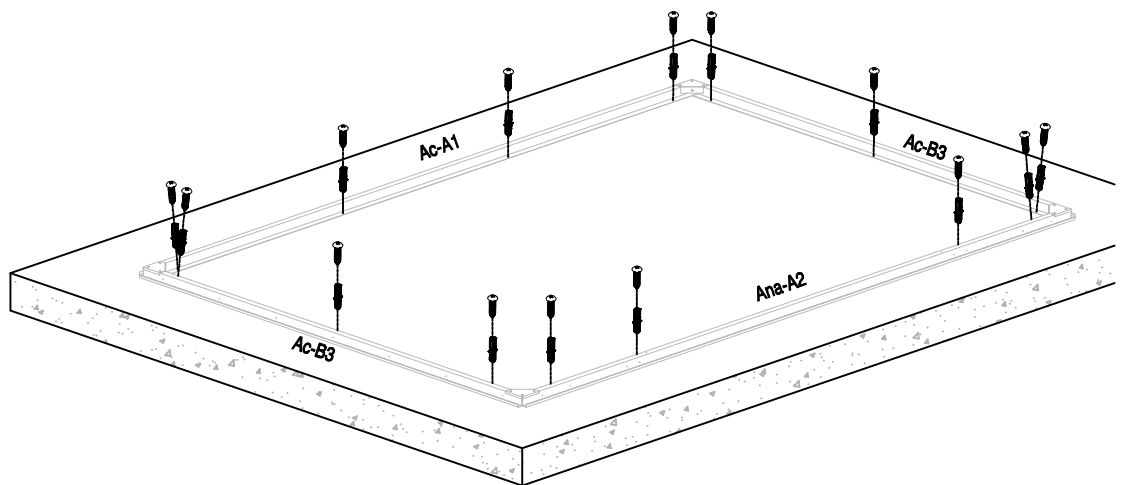
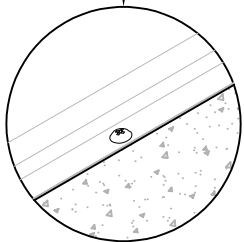
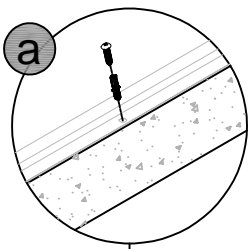
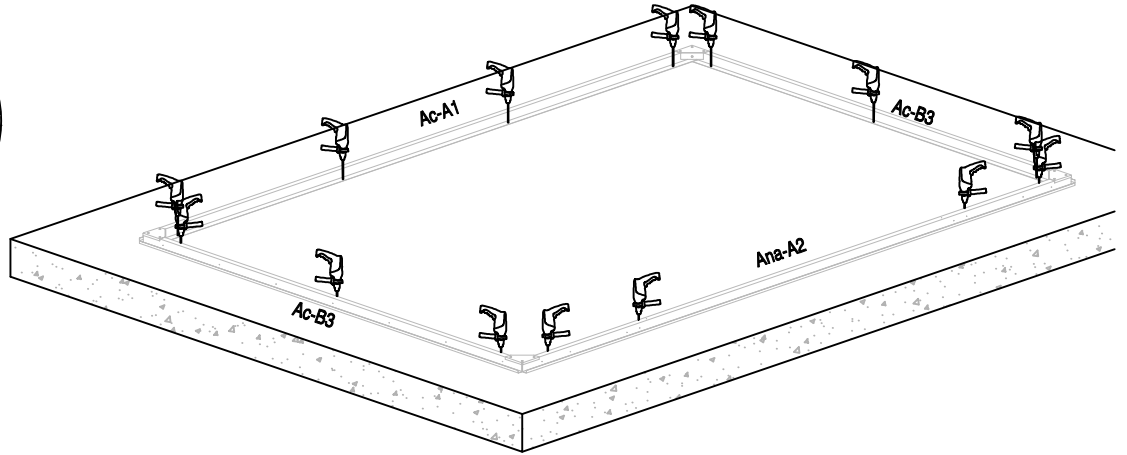
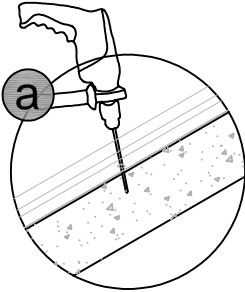
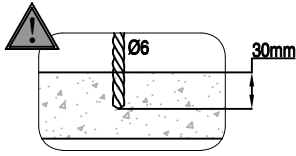
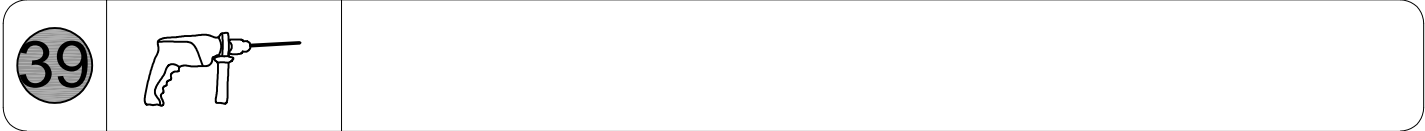

Gardiun

SPACES TO ENJOY

Kovyx Outdoor, S.L

CIFB83904086
Avenida de Andalucía nº 208 A
Salida 24 dirección Madrid
28341 Valdemoro, Madrid

Tel: (+34) 911 34 50 46
E-mail: info@kovyx.com

Servicio Post-Venta
Tel: (+34) 918 09 62 29
E-mail: spv@kovyx.com